

**PUB. 148**  
**SAILING DIRECTIONS**  
**(ENROUTE)**



**CARIBBEAN SEA**  
**VOLUME II**



Prepared and published by the  
NATIONAL GEOSPATIAL-INTELLIGENCE AGENCY  
Springfield, Virginia

© COPYRIGHT 2013 BY THE UNITED STATES GOVERNMENT  
NO COPYRIGHT CLAIMED UNDER TITLE 17 U.S.C.

**2013**



**FIFTEENTH EDITION**

## Preface

---

Pub. 148, Sailing Directions (Enroute) Caribbean Sea Volume II, Fifteenth Edition, 2013, is issued for use in conjunction with Pub. 140, Sailing Directions (Planning Guide) North Atlantic Ocean and Adjacent Seas. Companion volumes are Pubs. 141, 142, 143, 145, 146, and 147. Digital Nautical Charts 14 and 15 provide electronic chart coverage for the area covered by this publication.

This publication has been corrected to 17 August 2013, including Notice to Mariners No. 33 of 2013.

### Explanatory Remarks

Sailing Directions are published by the National Geospatial-Intelligence Agency (NGA), under the authority of Department of Defense Directive 5105.40, dated 12 December 1988, and pursuant to the authority contained in U. S. Code Title 10, Sections 2791 and 2792 and Title 44, Section 1336. Sailing Directions, covering the harbors, coasts, and waters of the world, provide information that cannot be shown graphically on nautical charts and is not readily available elsewhere.

Sailing Directions (Enroute) include detailed coastal and port approach information which supplements the largest scale chart produced by the National Geospatial-Intelligence Agency. This publication is divided into geographic areas called "Sectors."

**Bearings.**—Bearings are true, and are expressed in degrees from 000° (north) to 360°, measured clockwise. General bearings are expressed by initial letters of points of the compass (e.g. N, NNE, NE, etc.). Adjective and adverb endings have been discarded. Wherever precise bearings are intended degrees are used.

**Charts.**—Reference to charts made throughout this publication refer to both the paper chart and the Digital Nautical Chart (DNC).

**Coastal Features.**—It is assumed that the majority of ships have radar. Available coastal descriptions and views, useful for radar and visual piloting are included in geographic sequence in each Sector.

**Corrective Information.**—Users should refer corrections, additions, and comments to NGA's Maritime Operations Desk, as follows:

1. Toll free: 1-800-362-6289
2. Commercial: 571-557-5455
3. DSN: 547-5455
4. DNC web site: <http://dnc.nga.mil/NGAPortal/DNC.portal>
5. Maritime Domain web site: <http://msi.nga.mil/NGAPortal/MSI.portal>
6. E-mail: [navsafety@nga.mil](mailto:navsafety@nga.mil)
7. Mailing address: Maritime Safety Office  
National Geospatial-Intelligence Agency  
Mail Stop N64-SH  
7500 Geoint Drive  
Springfield VA 22150-7500

New editions of Sailing Directions are corrected through the date of the publication shown above. Important information to amend material in the publication is available as a Publication Data Update (PDU) from the NGA Maritime Domain web site.

**NGA Maritime Domain Website**  
<http://msi.nga.mil/NGAPortal/MSI.portal>

**Courses.**—Courses are true, and are expressed in the same manner as bearings. The directives "steer" and "make good" a course mean, without exception, to proceed from a point of origin along a track having the identical meridional angle as the designated course. Vessels following the directives must allow for every influence tending to cause deviation from such track, and navigate so that the designated course is continuously being made good.

**Currents.**—Current directions are the true directions toward which currents set.

**Dangers.**—As a rule outer dangers are fully described, but inner dangers which are well-charted are, for the most part, omitted. Numerous offshore dangers, grouped together, are mentioned only in general terms. Dangers adjacent to a coastal passage or fairway are described.

**Distances.**—Distances are expressed in nautical miles of 1 minute of latitude. Distances of less than 1 mile are expressed in meters, or tenths of miles.

**Geographic Names.**—Geographic names are generally those used by the nation having sovereignty. Names in parentheses following another name are alternate names that may appear on some charts. In general, alternate names are quoted only in the principal description of the place. Diacritical marks, such as accents, cedillas, and circumflexes, which are related to specific letters in certain foreign languages, are not used in the interest of typographical simplicity. Geographic names or their spellings do not necessarily reflect recognition of the political status of an area by the United States Government.

**Heights.**—Heights are referred to the plane of reference used for that purpose on the charts and are expressed in meters.

**Index-Gazetteer.**—Navigational features and place names are listed alphabetically in the back of the book. The approximate position, along with the Sector and paragraph numbers (e.g. **1.1**), facilitate location in the text.

**Internet Links.**—This publication provides internet links to web sites concerned with maritime navigational safety, including but not limited to, Federal government sites, foreign Hydrographic Offices, and foreign public/private port facilities. NGA makes no claims, promises, or guarantees concerning the accuracy, completeness, or adequacy of the contents of the web sites and expressly disclaims any liability for errors and omissions of these web sites.

**Light and Fog Signals.**—Lights and fog signals are not described, and light sectors are not usually defined. The Light Lists should be consulted for complete information.

**Ports.**—Directions for entering ports are depicted where appropriate by means of chartlets, sketches, and photos, which facilitate positive identification of landmarks and navigational aids. These chartlets and sketches are not always to scale, how-

---

ever, and should be used only as a general informational guide in conjunction with the best scale chart. Specific port facilities are omitted from the standard format. They are tabulated in Pub. 150, World Port Index.

**Radio Navigational Aids.**—Radio navigational aids are not described in detail. Publication No. 117 Radio Navigational Aids and NOAA Publication, Selected Worldwide Marine Broadcasts, should be consulted.

**Soundings.**—Soundings are referred to the datum of the charts and are expressed in meters.

**Special Warnings.**—A Special Warning may be in force for the geographic area covered by this publication. Special Warnings are printed in the weekly Notice to Mariners upon promulgation and are reprinted annually in Notice to Mariners No. 1. A listing of Special Warnings currently in force is printed in each weekly Notice to Mariners, Section III, Broadcast Warnings, along with the notice number of

promulgation. Special Warnings are also available on the Maritime Division web site.

**Wind Directions.**—Wind directions are the true directions from which winds blow.

### Reference List

The principal sources examined in the preparation of this publication were:

British Hydrographic Department Sailing Directions.

Various port handbooks.

Reports from United States Naval and merchant vessels and various shipping companies.

Other U.S. Government publications, reports, and documents.

Charts, light lists, tide and current tables, and other documents in possession of the Agency.

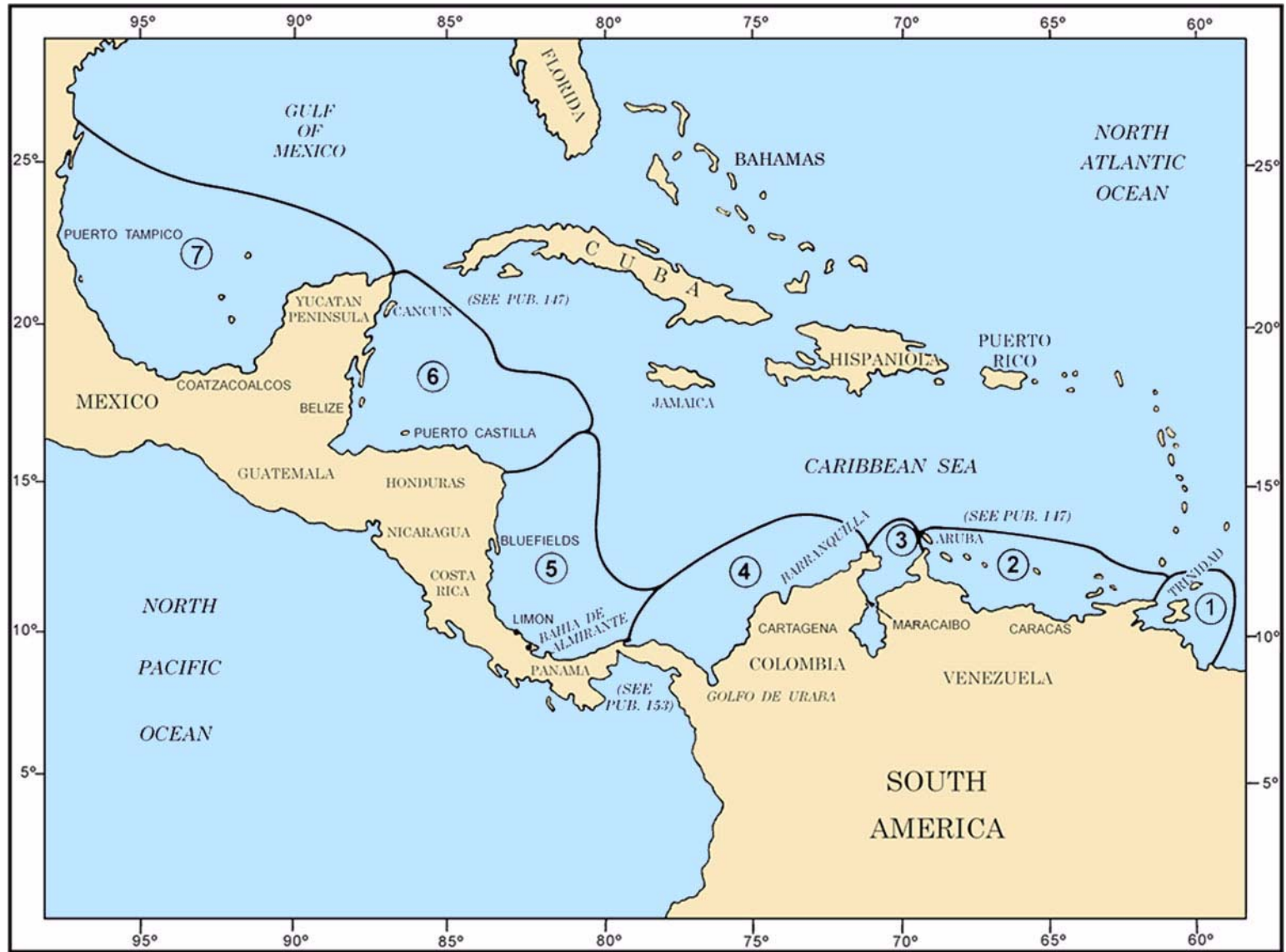

SECTOR LIMITS — PUB. 148

## Conversion Tables

---

### Feet to Meters

Feet	0	1	2	3	4	5	6	7	8	9
0	0.00	0.30	0.61	0.91	1.22	1.52	1.83	2.13	2.44	2.74
10	3.05	3.35	3.66	3.96	4.27	4.57	4.88	5.18	5.49	5.79
20	6.10	6.40	6.71	7.01	7.32	7.62	7.92	8.23	8.53	8.84
30	9.14	9.45	9.75	10.06	10.36	10.67	10.97	11.28	11.58	11.89
40	12.19	12.50	12.80	13.11	13.41	13.72	14.02	14.33	14.63	14.93
50	15.24	15.54	15.85	16.15	16.46	16.76	17.07	17.37	17.68	17.98
60	18.29	18.59	18.90	19.20	19.51	19.81	20.12	20.42	20.73	21.03
70	21.34	21.64	21.95	22.25	22.55	22.86	23.16	23.47	23.77	24.08
80	24.38	24.69	24.99	25.30	25.60	25.91	26.21	26.52	26.82	27.13
90	27.43	27.74	28.04	28.35	28.65	28.96	29.26	29.57	29.87	30.17

### Fathoms to Meters

Fathoms	0	1	2	3	4	5	6	7	8	9
0	0.00	1.83	3.66	5.49	7.32	9.14	10.97	12.80	14.63	16.46
10	18.29	20.12	21.95	23.77	25.60	27.43	29.26	31.09	32.92	34.75
20	36.58	38.40	40.23	42.06	43.89	45.72	47.55	49.38	51.21	53.03
30	54.86	56.69	58.52	60.35	62.18	64.01	65.84	67.67	69.49	71.32
40	73.15	74.98	76.81	78.64	80.47	82.30	84.12	85.95	87.78	89.61
50	91.44	93.27	95.10	96.93	98.75	100.58	102.41	104.24	106.07	107.90
60	109.73	111.56	113.39	115.21	117.04	118.87	120.70	122.53	124.36	126.19
70	128.02	129.85	131.67	133.50	135.33	137.16	138.99	140.82	142.65	144.47
80	146.30	148.13	149.96	151.79	153.62	155.45	157.28	159.11	160.93	162.76
90	164.59	166.42	168.25	170.08	171.91	173.74	175.56	177.39	179.22	181.05

### Meters to Feet

Meters	0	1	2	3	4	5	6	7	8	9
0	0.00	3.28	6.56	9.84	13.12	16.40	19.68	22.97	26.25	29.53
10	32.81	36.09	39.37	42.65	45.93	49.21	52.49	55.77	59.06	62.34
20	65.62	68.90	72.18	75.46	78.74	82.02	85.30	88.58	91.86	95.14
30	98.42	101.71	104.99	108.27	111.55	114.83	118.11	121.39	124.67	127.95
40	131.23	134.51	137.80	141.08	144.36	147.64	150.92	154.20	157.48	160.76
50	164.04	167.32	170.60	173.88	177.16	180.45	183.73	187.01	190.29	193.57
60	196.85	200.13	203.41	206.69	209.97	213.25	216.54	219.82	223.10	226.38
70	229.66	232.94	236.22	239.50	242.78	246.06	249.34	252.62	255.90	259.19
80	262.47	265.75	269.03	272.31	275.59	278.87	282.15	285.43	288.71	291.99
90	295.28	298.56	301.84	305.12	308.40	311.68	314.96	318.24	321.52	324.80

### Meters to Fathoms

Meters	0	1	2	3	4	5	6	7	8	9
0	0.00	0.55	1.09	1.64	2.19	2.73	3.28	3.83	4.37	4.92
10	5.47	6.01	6.56	7.11	7.66	8.20	8.75	9.30	9.84	10.39
20	10.94	11.48	12.03	12.58	13.12	13.67	14.22	14.76	15.31	15.86
30	16.40	16.95	17.50	18.04	18.59	19.14	19.68	20.23	20.78	21.33
40	21.87	22.42	22.97	23.51	24.06	24.61	25.15	25.70	26.25	26.79
50	27.34	27.89	28.43	28.98	29.53	30.07	30.62	31.17	31.71	32.26
60	32.81	33.36	33.90	34.45	35.00	35.54	36.09	36.64	37.18	37.73
70	38.28	38.82	39.37	39.92	40.46	41.01	41.56	42.10	42.65	43.20
80	43.74	44.29	44.84	45.38	45.93	46.48	47.03	47.57	48.12	48.67
90	49.21	49.76	50.31	50.85	51.40	51.95	52.49	53.04	53.59	54.13

## Abbreviations

---

The following abbreviations may be used in the text:

### Units

°C	degree(s) Centigrade	km	kilometer(s)
cm	centimeter(s)	m	meter(s)
cu.m.	cubic meter(s)	mb	millibars
dwt	deadweight tons	MHz	megahertz
FEU	forty-foot equivalent units	mm	millimeter(s)
grt	gross registered tons	nrt	net registered tons
kHz	kilohertz	TEU	twenty-foot equivalent units

### Directions

N	north	S	south
NNE	northnortheast	SSW	southsouthwest
NE	northeast	SW	southwest
ENE	eastnortheast	WSW	westsouthwest
E	east	W	west
ESE	eastsoutheast	WNW	westnorthwest
SE	southeast	NW	northwest
SSE	southsoutheast	NNW	northnorthwest

### Vessel types

LASH	Lighter Aboard Ship	Ro-Ro	Roll-on Roll-off
LNG	Liquified Natural Gas	ULCC	Ultra Large Crude Carrier
LPG	Liquified Petroleum Gas	VLCC	Very Large Crude Carrier
OBO	Ore/Bulk/Oil	Lo-Lo	Lift-on Lift-off

### Time

ETA	estimated time of arrival	GMT	Greenwich Mean Time
ETD	estimated time of departure	UTC	Coordinated Universal Time

### Water level

MSL	mean sea level	LWS	low water springs
HW	high water	MHWN	mean high water neaps
LW	low water	MHWS	mean high water springs
MHW	mean high water	MLWN	mean low water neaps
MLW	mean low water	MLWS	mean low water springs
HWN	high water neaps	HAT	highest astronomical tide
HWS	high water springs	LAT	lowest astronomical tide
LWN	low water neaps		

### Communications

D/F	direction finder	MF	medium frequency
R/T	radiotelephone	HF	high frequency
GMDSS	Global Maritime Distress and Safety System	VHF	very high frequency
LF	low frequency	UHF	ultra high frequency

### Navigation

LANBY	Large Automatic Navigation Buoy	SBM	Single Buoy Mooring
NAVSAT	Navigation Satellite	SPM	Single Point Mooring
ODAS	Ocean Data Acquisition System	TSS	Traffic Separation Scheme
CBM	Conventional Buoy Mooring System	VTC	Vessel Traffic Center
MBM	Multi-Buoy Mooring System	VTS	Vessel Traffic Service

### Miscellaneous

AIS	Automatic Identification System	MMSI	Maritime Mobile Service Identity Code
COLREGS	Collision Regulations	No./Nos.	Number/Numbers
IALA	International Association of Lighthouse Authorities	PA	Position approximate
		PD	Position doubtful

The following abbreviations may be used in the text:

IHO	International Hydrographic Organization
IMO	International Maritime Organization
LOA	length overall

Pub.	Publication
SOLAS	International Convention for Safety of Life at Sea
St./Ste.	Saint/Sainte

## Contents

---

Preface.....	II
Chartlet—Sector Limits .....	V
Conversion Tables.....	VI
Abbreviations .....	VII
Sector 1	
Trinidad and Tobago and the Coast of Venezuela—The Gulf of Paria and the Rio Orinoco .....	1
Sector 2	
Aruba, Bonaire, Curacao, and the Coast of Venezuela—Punta Penas to Cabo San Roman, with Off-lying Islands and Dangers .....	33
Sector 3	
Golfo de Venezuela and Lago de Maracaibo .....	73
Sector 4	
Coasts of Colombia and Panama—Punta Gallinas to and including the Panama Canal .....	87
Sector 5	
Coasts of Panama, Costa Rica, and Nicaragua—The Panama Canal to Cabo Gras a Dios .....	119
Sector 6	
Coasts of Honduras, Guatemala, Belize, and Mexico—Cabo Gracias a Dios to Cabo Catoche .....	139
Sector 7	
Coast of Mexico—Cabo Catoche to the Rio Grande .....	173
Glossaries .....	197
Index—Gazetteer .....	203



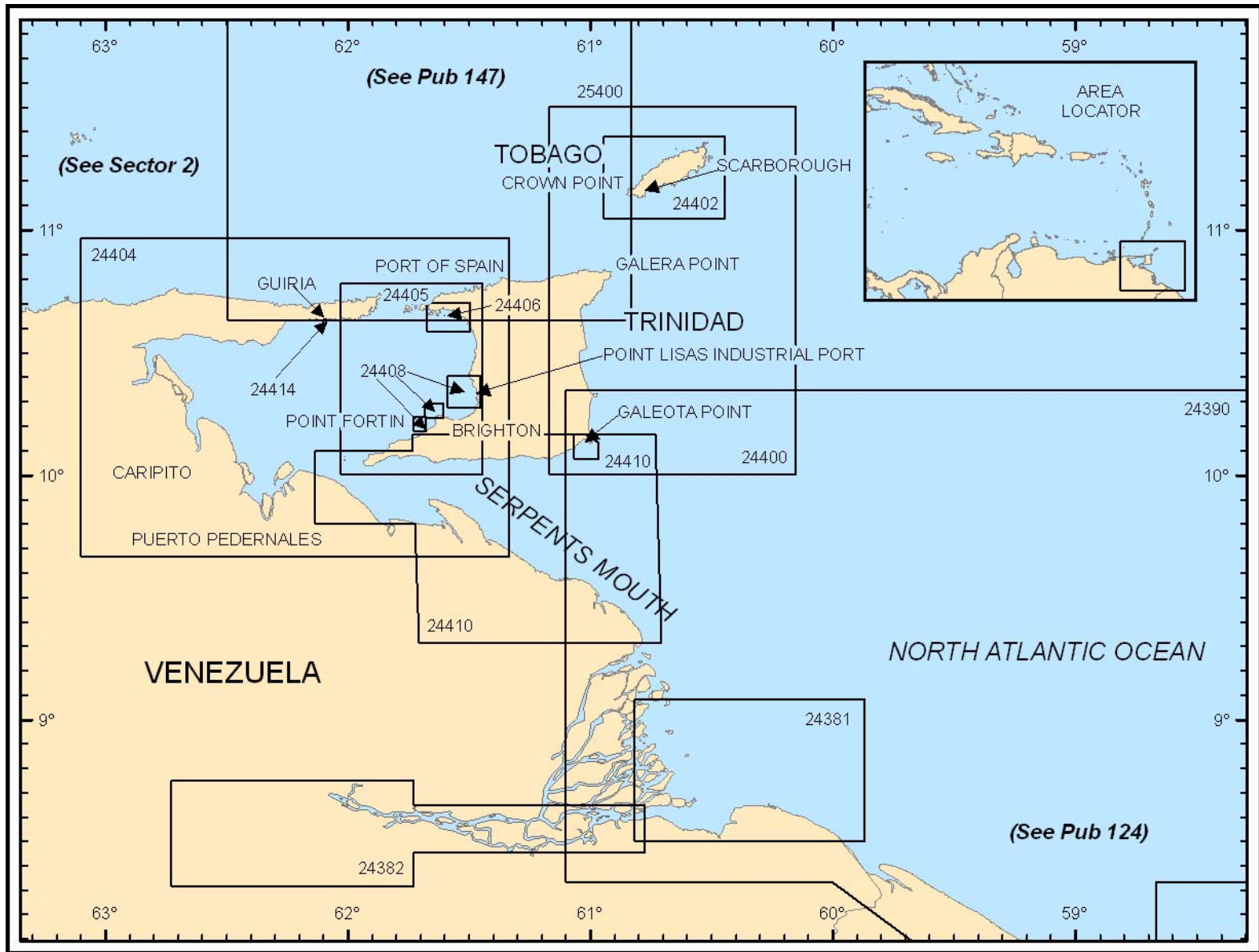

Additional chart coverage may be found in NGA/DLIS Catalog of Maps, Charts, and Related Products (Unlimited Distribution).

**SECTOR 1 — CHART INFORMATION**

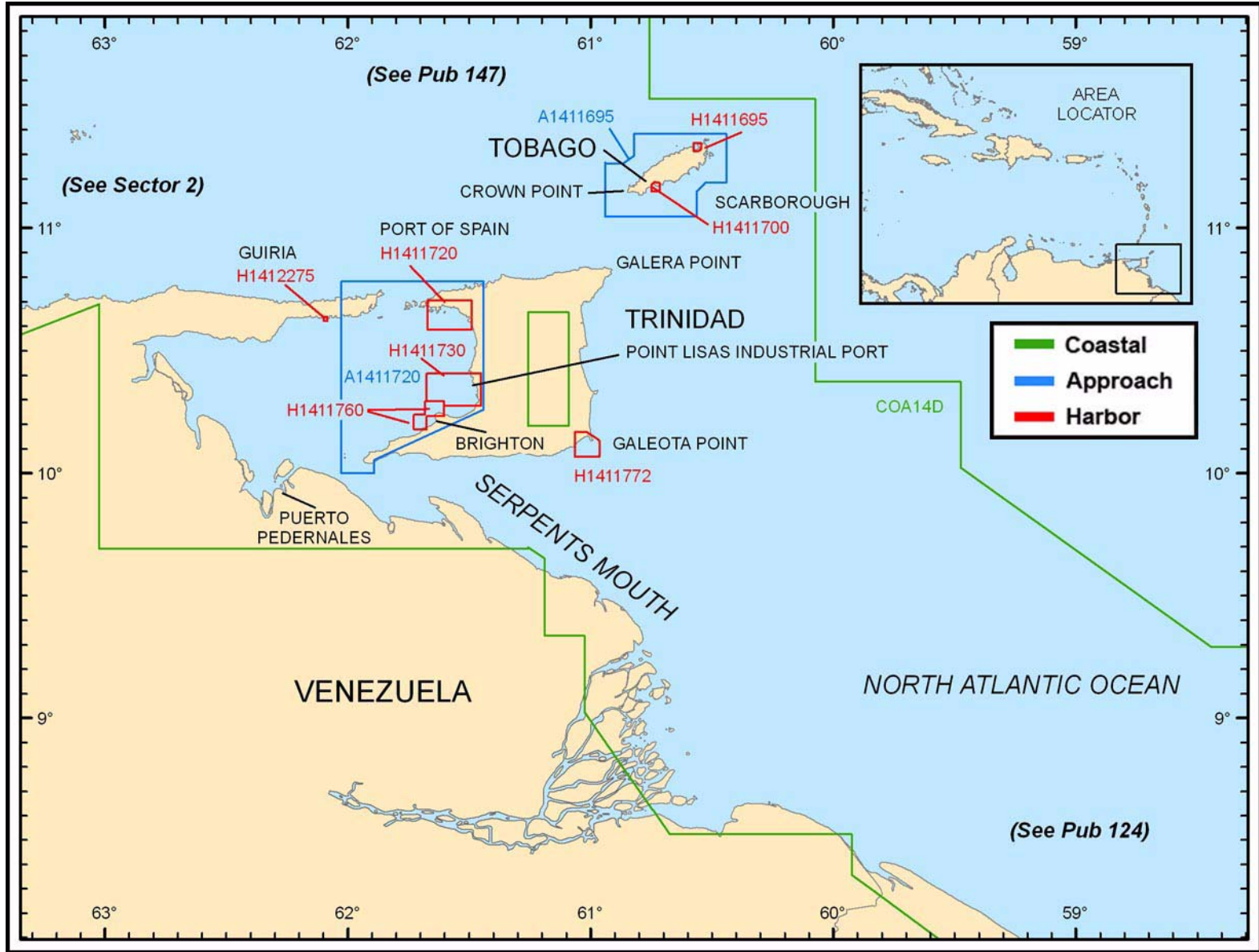

Additional DNC library coverage may be found in NGA DNC 14 (Limited Distribution) disc within the README\GRAPHICS folder.

SECTOR 1 — DNC LIBRARY INFORMATION

# SECTOR 1

## TRINIDAD AND TOBAGO AND THE COAST OF VENEZUELA—THE GULF OF PARIA AND THE RIO ORINOCO

**Plan.**—This sector first describes Tobago and then the N, E, and S coasts of Trinidad. The approaches to the Gulf of Paria are then described, including Dragons Mouth and Serpents Mouth. The W coast of Trinidad and the W shores of the Gulf are then described in a N to S sequence. The tributaries of the Rio Orinoco flowing into the Gulf of Paria and its S approach are described with the Gulf of Paria. The Boca Grande waterway of the Rio Orinoco is described separately.

### General Remarks

**1.1** Tobago, the outermost island described in this sector, is 26 miles long and lies 19 miles NNE of Trinidad. Trinidad and Tobago is an independent member state of the British Commonwealth.

Trinidad, the second largest and southernmost island of the West Indies, lies 7 miles from the NE extremity of Venezuela. It is 50 miles long, 37 miles wide, and is crossed by two mountain systems. Port of Spain, the principal commercial port, is situated on the W coast of the island.

Vessels passing between Tobago and Trinidad must avoid Drew Bank (11°05'N., 60°50'W.) and the shoals lying on it. Less water than charted was reported (1986) to lie on this bank. The bank and several unmarked off-lying dangers lying off the E coast of Trinidad require prudent navigation when in this vicinity. Vessels may stay clear of Drew Bank by keeping outside the 40m curve, which may best be seen on the chart.

The Gulf of Paria lies between Trinidad and the mainland coast of Venezuela. Several ports are situated within the gulf.

The Venezuelan river ports of Caripito and Pedernales are entered through river entrances, which lie in the SW and S part of the gulf.

Vessels proceeding to the ports within the gulf generally prefer to use the Boca Grande Channel of the Dragons Mouth due to the intricate passages of Serpents Mouth and the numerous oil platforms and drilling rigs situated in the middle and S parts of the gulf.

The Boca Grande waterway of the Rio Orinoco, which lies 110 miles SE of Serpents Mouth, is the only improved and maintained channel for vessels proceeding to Palua, Puerto Ordaz, and Ciudad Bolivar.

**Winds—Weather.**—The area covered by this sector lies at the SW end of the NE trade wind system of the North Atlantic. Over the open sea to the N of 10°N, winds from the E and NE predominate for most of the year. These winds do not generally exceed force 6, except in heavy squalls. Land and sea breezes occur along the mainland coast and to some extent around Trinidad; however, they are seldom strong enough to do more than modify the prevailing trade wind.

The main hurricane season in the E part of the Caribbean usually occurs from the beginning of August to mid-September, but has been known to occur as early as June and as late as November. The storms usually do not come S of 12°N, but a

heavy swell and rough seas may be experienced along the coastal area. Only one hurricane passed S of Trinidad in the years from 1901 to 1963, and the only one to affect Trinidad in these years did so in the month of June.

Squalls of varying intensity are rather common, especially those associated with thunderstorms, which are more frequent near the land than over the open sea. White squalls, which are squalls with little or no cloud, may occur in any season, both along the coast and at sea, and are usually accompanied by a turbulent sea which rapidly subsides when the squall has passed.

Fog is practically unknown at sea and is uncommon on the coast.

Temperatures are almost uniformly high and, when accompanied by high humidity, can cause some discomfort especially in calm conditions.

**Tides—Currents.**—The surface currents described in this sector are governed by the North Equatorial Current and the South Equatorial Current. Current speeds and directions vary only slightly with the seasons and generally set W or NW. The greatest local variations in the current pattern result from winds and storms.

Off the N coasts of Trinidad and the Peninsula de Paria, the current becomes strongest from July to October, with speeds ranging between 1.5 and 2 knots. River discharges in the E part of Venezuela exert considerable influence on coastal water movements, especially during the rainy season. The same is true of the water flowing into the Gulf of Paria during the rainy season through Serpents Mouth and out of Dragons Mouth. The rate of the currents at such times may range from 2 to 2.5 knots. The current turns W and joins the Equatorial Current to the N of Dragons Mouth.

Under normal weather conditions, the tidal currents flow into the Gulf of Paria from both ends through Dragons Mouth and Serpents Mouth while the tide is rising. They flow out through both channels while the tide is falling. 6/26/06 Removed old line drawing.

### Tobago

**1.2** **Tobago** (11°15'N., 60°40'W.), lying 19 miles NNE of Trinidad, has steep-to coasts and, in places, is indented by bays, some of which are suitable as anchorages. A ridge of irregular mountains, which attains an elevation of 582m, extends almost two thirds of the length of the island from its NE extremity. The summits of this ridge are mostly rounded and do not have any of the volcanic features that can be seen in some of the islands to the N. The slope on the N side of the ridge is generally steep, but on the S side there are several fertile valleys which lie between the spurs of the hills extending to the coast. The SW section of the island consists of low-lying plains, from which numerous hills rise.

During the winter, the NW side of the island is subject to a

ground swell which occasionally breaks heavily over Buccoo Reef and Drew Bank, SW of Crown Point. At such times, vessels have to leave the bays on that side of the island. The SE side of the island is continually exposed to a heavy swell.

Scarborough, at Rockly Bay on the SW side of the island, is the chief town, while Charlottesville, at Man-of-War Bay on the NE side of the island, is the largest.

Anchorage can be taken in Man-of-War Bay, Great Courland Bay, King's Bay, and Rockly Bay. The latter bay is most frequented by vessels; however, King's Bay is deeper and provides shelter from prevailing winds.

The **Saint Giles Islands** (Melville Islands) ( $11^{\circ}21'N.$ ,  $60^{\circ}31'W.$ ), a rocky and steep-to group, lie 0.5 mile N of the NE extremity of Tobago. The southernmost and largest island is 114m high. Marble Island, the N of the group, is 45m high and almost white. London Bridge is 49m high and the W island of the group. It is formed by a prominent rock, shaped like an arch. A light is shown from the E end of the Saint Giles Islands.

A rock, awash, lies midway between the largest island of the Saint Giles group and the NE extremity of Tobago. Pointed Rock lies close NE of the latter point. There is a least depth of 27m in the channels lying on either side of the rock, awash, but they are both narrow and a considerable current sets through them. Vessels are advised to pass N of the Saint Giles Islands outside of the 40m curve.

**1.3 Man-of-War Bay** ( $11^{\circ}19'N.$ ,  $60^{\circ}34'W.$ ) is entered between North Point, located 1.8 miles WSW of the N extremity of Tobago, and Corvo Point, 1.5 miles WSW. It recedes about 1 mile to the head. A reef fringes North Point and extends up to 0.1 mile N of it. An islet lies near the seaward extremity of this reef. Booby Island, 33m high and steep-to, lies near the head of the bay and a detached patch, with a depth of 4.3m, lies close NE of it.

A light is shown at the head of the bay, 0.7 mile E of Booby Island.

The E and S shores of the bay are fronted by a reef. Several above-water rocks lie on this reef and on all sides of the bay. An islet, 37m high, lies 0.5 mile ESE of Corvo Point; Cardinal Rock, which dries 0.5m, lies 0.2 mile E of the point.

**Charlottetown** ( $11^{\circ}19'N.$ ,  $60^{\circ}33'W.$ ) is situated in the SE corner of Man-of-War Bay and may be identified by some scattered small houses and a row of bungalows on the shore.

Hermitage House stands on the SW side of the bay, 0.8 mile SW of Corvo Point. This conspicuous dwelling has a green roof and is surrounded by trees. An anchorage, with depths of 22 to 33m, lies within Man-of-War Bay. Smaller vessels can anchor close inshore.

Between Corvo Point and **Courland Point** ( $11^{\circ}13'N.$ ,  $60^{\circ}47'W.$ ), 13.5 miles SW, the coast is generally steep-to and rocky.

The Brothers, consisting of two rocks, lie close offshore, about 2 miles W of Corvo Point, and are 5m high. Two isolated rocks, which break, lie in the vicinity of the 40m curve, WSW of The Brothers. The passage leading between The Brothers and The Sisters should not be attempted.

**The Sisters** ( $11^{\circ}20'N.$ ,  $60^{\circ}39'W.$ ), a group of rocks, lie 3.5 miles W of Corvo Point and are marked by a light. The N rock of this group is 30m high.

This part of the coast is indented by several small bays. From the NE they are Bloody Bay, Parlatuvier Bay, Englishman's Bay, Castara Bay, King Peter's Bay, and Fromager Bay. These bays only afford anchorage to small craft with local knowledge. Castara Bay, lying 7.5 miles SW of Corvo Point, is the only one that affords any shelter.

**Caution.**—An ODAS buoy is positioned about 9 miles NW of The Sisters. Mariners are advised to navigate in the area with caution.



**Englishman's Bay**

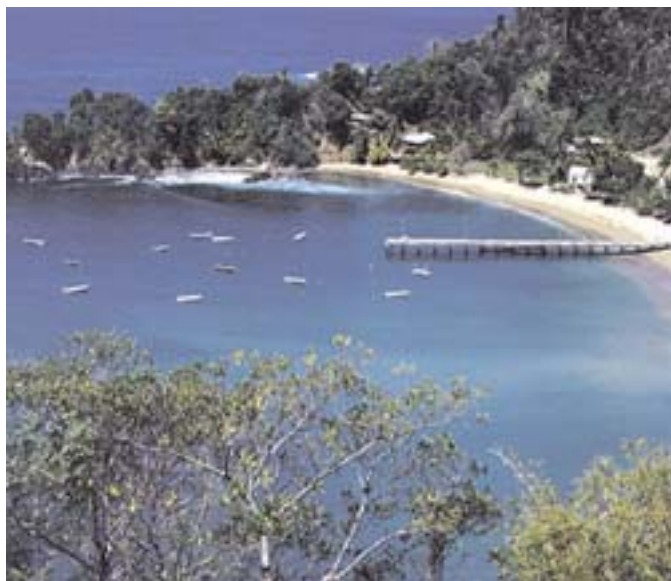

**Parlatuvier Bay**

**1.4 Great Courland Bay** ( $11^{\circ}12'N.$ ,  $60^{\circ}47'W.$ ), a slight indentation, is entered between Courland Point and Hawk's

Bill, 0.8 mile SSW. A light is shown from Courland Point.

Barrel of Beef, a rock, has a depth of 0.6m and lies about 0.2 mile SSW of Courland Point. A rock, above-water, lies between the latter point and Barrel of Beef.

Plymouth is situated in the NE corner of Great Courland Bay. The church, a wooden building with a red roof and a small spire, stands in the SW part of the town. The remains of an old fort stand on the S side of Courland Point. A pier, in ruins, extends from the shore abreast of the town.

Anchorage can be taken, in a depth of 18m, about 0.5 mile SW of Courland Point. Small vessels can anchor closer in. No vessels should anchor in depths of less than 13m. When the wind is from the NE, a swell sets into the bay, but the holding ground is good. This is the principal anchorage on the NW side of Tobago.

Stone Haven Bay is entered between Hawk's Bill and Rocky Point, 1 mile SW. It is exposed and of little use as an anchorage.

Little Courland Bay (Mount Irvine Bay) is entered between Rocky Point and Booby Point, 1 mile SW. A rock, 11m high, lies close off the latter point. A white house, with a red roof, stands on high ground about 0.8 mile ESE of Booby Point.

Anchorage can be obtained, in a depth of 13m, within the NE part of the bay. The berth lies with the white house bearing 166° and about 0.8 mile distant. This anchorage, although preferable to that in Great Courland Bay, may at times become untenable.

**Caution.**—Care should be taken to avoid numerous fish nets and traps which may be encountered in the N part of Great Courland Bay.

**1.5 Pigeon Point** (11°10'N., 60°50'W.) is located 1.8 miles WSW of Booby Point; Buccoo Bay is formed between the two points. A shoal, with a depth of 0.6m, lies about 0.2 mile W of Booby Point and breaks in heavy weather.

Buccoo Reef extends about 1.3 miles N and 0.5 mile NW from Pigeon Point. Its outer edge dries and is clearly defined. A small and sandy islet, 0.6m high, lies on the NE part of this reef. According to local information, the position of this islet may vary with changing weather conditions. Lighted buoys mark the N and W extremities of the reef.

Milford Bay, marked by a light close N of the airfield at its head, is entered between Pigeon Point and Sandy Point, 1.3 miles S. A rock, with a depth of 1.8m, lies on the edge of the shore bank, about 0.5 mile NNE of Sandy Point. A landing place is situated about 0.1 mile SSW of Pigeon Point.

When approaching Milford Bay, care should be taken not to round Crown Point or Buccoo Reef too closely.

**Crown Point** (11°09'N., 60°51'W.) marked by a light, is located 0.5 mile SSW of Sandy Point and forms the SW extremity of Tobago. The 5m curve lies about 0.4 mile offshore to the S of this point and breakers form on the ledge.

An SPM (National Petroleum Buoy) is moored about 0.5 mile WNW of the light, in a depth of 14m. Berthing takes place in daylight hours only.

**Caution.**—Three submarine cables, which may best be seen on the chart, extend SSW from the head of Milford Bay across Galleons Passage to Trinidad.

Anchorage is prohibited within 0.2 mile of the cables in Milford Bay and vessels should not anchor within 2 miles of the

cables in Galleons Passage.

**Tyrrel's Bay** (11°18'N., 60°32'W.) lies between a point located 2.5 miles S of the N extremity of Tobago and another point, 0.8 mile SSE. Its shores are fringed by reefs which extend up to about 0.3 mile seaward in places. A detached shoal, with two above-water rocks lying on it, is located about 0.3 mile ENE of the N entrance point of the bay.

**1.6 Little Tobago** (11°18'N., 60°30'W.), an irregularly-shaped island, is 141m high and lies 1 mile offshore, E of Tyrrel's Bay. Black Rock lies 0.5 mile NE of the N extremity of this island; Long Rock lies about 1 mile W of it. Goat Island lies in the mouth of the bay, 0.5 mile W of the island. The W side of Goat Island is fringed with reefs and numerous above-water rocks lie close off its N and S ends.

Several above and below-water rocks lie within 1 mile S of Little Tobago. Depths of 37 to 55m lie in the channels leading between Little Tobago and Goat Island, and between Goat Island and Tobago. The N current setting in these channels attains rates of 2.5 to 4 knots.

Anchorage can be taken, in depths of 26 to 44m, in the middle of Tyrrel's Bay, W of Goat Island.

The channel leading between South Rock (11°17'N., 60°31'W.) and Little Tobago should be avoided. The current divides SW of Little Tobago and sets through the channel at a considerable rate.

From the S entrance point of Tyrrel's Bay, the coast trends 1.5 miles S to Cape Gracias-a-Dios (11°16'N., 60°32'W.) and then about 1 mile SSW to Pedro Point. This stretch of shore should be avoided by small craft as the current setting constantly against the wind raises a rough sea.

**Kings Bay** (11°15'N., 60°33'W.) is entered between Pedro Point and a point located 1.3 miles SW. The bay extends about 1 mile NW. A detached shoal patch, with a depth of 11.9m, lies in the middle of the bay, WNW of Pedro Point. A shoal, with a depth of 6.1m, and a rock, with a depth of 2.7m, lie about 0.2 mile NE and about 0.3 mile NW, respectively, of the above patch.

The best anchorage in Tobago may be obtained within King's Bay, which is sheltered from the prevailing winds. The best berth lies near the head of the bay, in depths of 22 to 37m, fine sand, with practically no tidal current.

**Queen's Island** (11°14'N., 60°33'W.), which is 55m high, lies close offshore, about 0.5 mile SSW of the SW entrance point of King's Bay. A rock, which dries 0.6m, lies about 0.1 mile S of the island; another rock, 3m high, lies close N of it.

Queen's Bay, entered close W of Queen's Island, has several shoal patches lying across its entrance, but provides anchorage to small craft with local knowledge.

Roxborough Rock, 16m high, lies 0.8 mile WSW of Queen's Island. Richmond Island, 44m high, lies 0.2 mile offshore, 2.3 miles SW of Queen's Island. This island is divided into two parts, with a hummock on each. The bight lying between this island and Queen's Island is known as Carapuse Bay.

Mangrove Bay, Richmond Bay, and Goldsborough Bay lie SW of Richmond Island. These bays afford anchorage to small vessels with local knowledge.

Goldsborough Bay and the coast extending for about 1 mile SW of it is bordered by Great River Shoal (11°12'N., 60°37'W.). This shoal has depths 4.5 to 9m; the sea breaks

heavily over it during strong ESE winds.

**1.7 Granby Point** (11°11'N., 60°40'W.), surmounted by the ruins of a fort, is located 4.3 miles SW of Richmond Island. Smith Island, marked by a light, lies about 0.1 mile ESE of the point. This island is 15m high; a rock lies close SW of it.

Barbados Bay lies NW of Granby Point. Hillsborough Bay is located W of the point. The latter bay is clear of dangers and provides anchorage, in a depth of 11m, within its E part.

A bank extends about 0.5 mile E from the coast, 1.3 miles SSW of the head of Hillsborough Bay. It has a least depth of 6.5m, which breaks during a strong breeze.

Minster Point, located 2.5 miles WSW of Granby Point, is 52m high. Minster Bay is entered between this point and Bacolet Point, 0.8 mile SW. A rock, which dries 0.5m, lies about 0.5 mile WSW of Minster Point. Minster Rock is composed of several large boulders. It has a least depth of 2m and lies 0.5 mile SSW of Minster Point. This rock usually breaks and is marked by a lighted buoy moored close WSW of it.

**Rockly Bay** (11°10'N., 60°44'W.) is entered between Bacolet Point and Lowlands Point, 3.8 miles SW. The town of Scarborough, fronted by a port area, stands in its NW part. Lowlands Point, which is 14m high, is fronted by a reef extending up to 0.1 mile seaward.

Red Rocks, 4m high, lie in the W part of the bay, 1.5 miles W of Bacolet Point. Middle Shoal, with a depth of 3.5m, lies near the approach to Scarborough, about 0.5 mile NE of Red Rocks.

The clear part of the roadstead, which lies along the NE side of the bay, has depths of 11 to 29m. The middle and W parts of the bay are encumbered by numerous unmarked shoals which break with fresh trade winds.

**1.8 Scarborough** (11°11'N., 60°44'W.) (World Port Index No. 11700), a small port, includes a roadstead and a small inner harbor at the head of the bay. Large vessels anchor in the roadstead and work cargo via lighters. The lighters must be arranged in advance from Port of Spain, Trinidad.



**Scarborough Port Terminal**

**Depths—Limitations.**—The harbor is formed by a breakwater which protects a wharf fronting its N side. The wharf is 150m long and has a depth of 4.5m alongside at LW. A jetty

extends 0.1 mile SSW from the N side of the harbor. Its W face, which is 180m long, has a depth of 9m alongside and is used by passenger vessels. Its E face, which is 150m long, has a depth of 8.5m alongside and is used by general cargo vessels. Two ro-ro berths are situated at the landward end of this berth.

Vessels of up to 200m in length and 8m draft can be accommodated in the harbor.

**Aspect.**—Fort George, along with several radio towers standing close N of it, is conspicuous from seaward. Burleigh House, a white building with a flat roof, stands 1.3 miles WSW of the town and is prominent. It is reported that the buildings in the town do not show up well until vessels reach the upper part of the bay.

A light is shown from the head of the breakwater. A marina and a fishing boat harbor lie close N of the breakwater.



**Fort George Light**

**Pilotage.**—Pilotage is compulsory for vessels over 50 grt. Pilots must be requested at least 48 hours in advance through Port of Spain, Trinidad. Vessels should contact the North Post Coast Radio Station. Pilots can be contacted by VHF and board about 0.3 mile SW of Lodge Point (11°10'N., 60°44'W.).

**Anchorage.**—Anchorage can be taken, in depths of 11 to 29m, mud and sand, near the head of Rockly Bay. These anchorages are safe, but the trade winds send in a continuous swell, making lighterage work difficult.

**Directions.**—Vessels approaching from the SW should keep Fort George Light bearing less than 012° until they are clear of the shoals extending ESE from Red Rocks (11°10'N., 60°45'W.). They should then steer on the lighted entrance range toward the anchorage. Vessels approaching from the E should stay clear of Minster Rock and then proceed as above.

**Caution.**—When approaching the port and embarking a pilot, vessels are advised to expect a W set caused by wind and currents. It has been reported (2009) that a wreck lies 270m SE of the breakwater.

**1.9 Columbus Point** (11°08'N., 60°48'W.), the S extrem-

ity of Tobago, is located 5.3 miles WSW of Bacolet Point. It is low and fringed with reefs.

Petit Trou, a small and foul bay, is entered close W of Lowlands Point, E of Columbus Point. A rocky bank, with depths of less than 5.5m, extends 0.5 mile E and about 0.1 mile S from the E entrance of the bay.

Crown Point is located 2.8 miles WNW of Columbus Point. A shoal flat extends up to about 1 mile offshore between these two points. Heavy breakers may be seen on the W edge of this flat, close off the point, even in the calmest weather.

**Drew Bank** (11°05'N., 60°50'W.), lying within the 40m curve, extends 4 miles S and then 7 miles W from a position located 2 miles S of Crown Point. It was reported (1986) that less water than charted was found on this bank.

Wasp Shoal, with a depth of 4.8m, lies on the N extremity of Drew Bank. It was reported (1986) that a depth of 1.5m was found in the vicinity of this shoal. The shoal is usually marked by overfalls and may cause unexpected and heavy breakers to form even in the calmest weather. The fairway of the channel leading between Wasp Shoal and Crown Point has depths of 15.8 to 33m. The tidal current in this channel sets strongly to the W.

**Drew Shoal** (11°05'N., 60°54'W.), with a least depth of 6m, lies near the SW extremity of Drew Bank. A ripple usually exists at the edge, and the whole NW side of the bank can be identified when the tidal current is running strongly.

## Trinidad

**1.10 Trinidad** (10°30'N., 61°15'W.), the southernmost island of the West Indies, is separated from Tobago by Galleons Passage. The island lies with Gallera Point, its NE extremity, located 19 miles SSW of Crown Point, Tobago. The Gulf of Paria indents the W side of the island. This gulf contains numerous safe anchorages for all classes of vessels, even during the hurricane season.

A ridge of heavily-wooded mountains, 450 to 940m high, extends along the N side of the island. El Cerro del Aripo, the tallest peak, is 940m high and rises 21 miles WSW of Galera Point. Mount Tacuche, 936m high, stands 10 miles W of El Cerro del Aripo. The interior of the island is low and swampy to the S of the ridge.

The S side of the island is bordered by a range of hills which are considerably lower than the mountains along the N side. Trinity Hill, 304m high, stands 8 miles W of Galeota Point, the SE extremity.

Naparima Hill, 177m high, stands close to the coast about 130 miles ENE of Punta del Arenal, the SW extremity of the island. It is the only elevation along the W coast.

The N coast of Trinidad is rocky and the sea breaks on it with such violence that it is impossible to land, except at a few places under favorable conditions. The best shelter for small vessels is in Maracas Bay.

The E coast of Trinidad is so straight that no anchorages are provided for large vessels, although there are a few places where small vessels can find temporary shelter. The best anchorage is in Cocos Bay, W of L'Ebranche Rocks.

The S coast of Trinidad has very few off-lying dangers.

The approaches to the N coast are generally clear, with most of the fringing dangers lying no more than 0.5 mile offshore.

**Delaware Bank** (10°50'N., 60°25'W.), a detached shoal, extends for about 3 miles. It has a least depth of 27m and lies centered 29 miles E of Galera Point. A shoal, with a depth of 14.6m, was reported to lie about 34.5 miles E of Galera Point.

Emerald Shoals, a coral bank about 6 miles long, has a least depth of 5.5m on its N part and lies 16 miles ESE of Galera Point. Prospector Patch, with a least depth of 11m, lies close E of this bank.

**Caution.**—Many drilling platforms, well heads, and pipelines exist off the coasts of Trinidad. Mariners are advised to exercise caution when navigating in the area. A platform designated as Pointsettia Platform, with a racon and radar beacon, stands about 27 miles N of Saint d'Eau Island close N of Tobago.

**1.11 Darien Rock** (10°32'N., 60°38'W.), lying 14 miles S of Emerald Shoals, is a detached and steep-to rocky head with a least depth of 2.4m. A wreck is located on this danger, which is occasionally marked by rips and breakers. When approaching this rocky head from the S, the numerous oil rigs in the vicinity make very useful marks for navigating around it.

**Manzanilla Bank** (10°24'N., 60°54'W.), with depths of less than 20m, extends about 17 miles ENE from Point Radix. The seaward end of this bank, which consists of several detached patches, has depths of 12 to 20m, coral. The current causes rips and a confused sea over parts of this bank.

**Tides—Currents.**—The South Equatorial Current enters the Caribbean Sea setting in a WNW direction at a rate of 3 knots. This current divides off the SE coast of Trinidad, with one part setting N along the E coast and then W into the Caribbean Sea. The other part flows W along the S coast into the Gulf of Paria and then N, finally emerging through Dragons Mouth. Close offshore and within the gulf, they may be reversed or offset by local tidal currents.

Along the N coast of Trinidad, E of Grande Riviere Bay, the E setting tidal currents are overcome by W currents setting between the island and Tobago. Close inshore, between Grande Riviere Bay and Chupara Point, the E tidal current sets along the coast for the last 2 hours of the ebb and sometimes for the whole duration. The E tidal current is always prevalent W of Chupara Point.

The current increases in strength and its direction becomes more N as Entrada Point is approached. The rate of the W tidal current decreases as Entrada Point is approached, but is greater offshore than near the coast.

Off the N entrance to the Gulf of Paria, the N and NW setting tidal currents attain rates of 2 to 3 knots according to the season of the year.

A branch of the Guiana Current sets through Serpents Mouth. This current turns N into the gulf and emerges through Dragons Mouth to rejoin the main body of the West Guiana Current, along the N coast of Trinidad.

Tidal currents in the N entrance to the Gulf of Paria seldom exceed a rate of 1 knot at springs.

Off the N entrance to the Gulf of Paria, the N flow attains a rate of 2 to 3 knots depending upon the season, the strength of the current, and the outflow from the Rio Orinoco. The outflow from this river is strongest between July and October. Rates of up to 5 knots may be experienced between the islands lying off the W coast of Trinidad.

**1.12 Galera Point** (10°50'N., 60°55'W.), 15m high, is rocky and covered by coconut palms. Neptune Rock, awash, lies 0.5 mile E of the point and always breaks. This danger should be given a berth of at least 1 mile because the current sets strongly toward it. The point is marked by a light and the structure has been reported to be radar conspicuous.



**Galera Point Light**

Mormaerland Bank, with a least depth of 20m, lies with its shallowest part located 3.8 miles N of Galera Point.

A bank, with a depth of 17m, and a detached shoal, with a depth of 13.5m, lie 3 miles NNW and about 1 mile N, respectively, of Galera Point.

**Toco Bay** (10°50'N., 60°57'W.) is entered between Reefs Point, located 1.8 miles W of Galera Point, and a group of above-water rocks lying close offshore, 1.5 miles WSW. A heavy swell rolls into this bay and it is not recommended as an anchorage.

Grande Riviere Bay, lying 6 miles W of Toco Bay, affords temporary anchorage, in a depth of 16.5m. The berth lies with the E end of a sandy beach at the head bearing 166° and the E entrance point bearing 086°.

**Grand Matelot Point** (10°49'N., 61°08'W.) is located 5 miles WSW of the W entrance of Grande Riviere Bay. The coast between is high and rocky, though in a few places there are sandy beaches. A number of above and below-water rocks front the coast and lie within the 10m curve. A light is shown from Petite Matelot Point, 1.5 miles E of Grand Matelot Point.

From Grand Matelot Point, the coast trends 13.5 miles W to Chupara Point. Vessels may anchor, in depths of up to 33m, mostly mud, anywhere off this stretch of coast and up to 1 mile offshore.

Machapure Rock, awash, lies 9 miles W of Grand Matelot Point and is the outermost danger off this part of the coast.

**1.13 Chupara Point** (10°49'N., 61°22'W.), marked by a light, the most prominent headland on the N coast of Trinidad, is steep, cliffy, and 118m high. It is reported to be radar conspicuous. Filette Point, the NE extremity of the headland, is fronted by above-water rocks extending up to about 0.5 mile E of it. A reef, which usually breaks, extends up to 0.3 mile W from the W extremity.

Chupara Bay is entered between Chupara Point and Abercromby Point, 2.5 miles SW. It affords anchorage sheltered by Chupara Point, but is not recommended. A radio mast, 61m high, stands 5.8 miles SSE of Chupara Bay.

Las Cuevas Bay is entered between Abercromby Point and Las Cuevas Point, 1.3 miles W. It provides anchorage with Abercromby Point bearing 065° and 0.3 mile distant, but is exposed to the prevailing N wind.

**Maracas Bay** (10°46'N., 61°26'W.), entered 1.5 miles W of Las Cuevas Bay, has a depth of 29m in its entrance and gradually shoals to a depth of 9m near the head. This bay, though open to the N, affords better shelter in its SE corner than any other anchorage along this coast. However, being under high land, the winds experienced here are variable.

La Vache Islet, 55m high, lies 4 miles W of Las Cuevas Point and close off a small point that separates Balata Bay from La Vache Bay. Neither of these two bays provides safe anchorage, nor do Morne Mal d'Estomac Bay and Sainte Cite Bay, lying farther W, because of the heavy swell setting into them.

**1.14 Maravaca Islet** (Saint d'Eau Islet) (10°46'N., 61°31'W.), 113m high, lies 0.5 mile N of Medine Point, which separates Morne Mal d'Estomac Bay from Sainte Cite Bay. The islet is wooded and marked by a light.

The coast between Medine Point and Corozal Point, 6 miles WSW, is bold, rocky, and without shelter. A conspicuous white tower stands on Corozal Point and a disused satellite tracking antenna, 35m high, stands 0.3 mile S of it.

North Post Signal Station stands, with its flagstaff and prominent radio masts, on a hill, 2.8 miles E of Corozal Point. It was reported (1990) that an artificial reef had been established within 0.3 mile of Corozal Point.

Maqueripe Bay, entered 1 mile SW of Corozal Point, has a below-water rock lying close N of its NE entrance point. Two other rocks, which break, lie off its SW side. In good weather, anchorage can be taken, in a depth of 44m, about 2.5 miles W of this bay.

**Gas Platform Hibiscus** (11°08'N., 61°40'W.), lighted with a racon, is situated about 25 miles NW of Chupara Point and about 24 miles N of Entrada Point. A submarine pipeline extends S from the platform to shore passing between Monos Island and Entrada Point across the Gulf of Paria and ashore near Point Fortin, as seen on the chart. Submarine pipelines also lie about 10 miles NE of the platform, about 45 miles W of Milford Bay, Tobago.

**1.15 Entrada Point** (10°43'N., 61°40'W.), the NW extremity of Trinidad, is located 4.3 miles SW of Corozal Point. A peak, 539m high, rises 2.3 miles E of the point and its easternmost summit is surmounted by a prominent radio tower.

The E coast of Trinidad between Galera Point and Galeota Point, 42 miles S, consists of one rocky stretch with three sandy beaches, each about 10 miles long. These beaches are



separated by irregular points of moderate height. A heavy surf rolls in along this entire section of the coast. Cumana Bay, with sandy beaches at its head, lies 3 miles SW of Galera Point and Guayamaya Point is located 1.8 miles S of it. The coast between the latter point and Islet a Bateau, lying 3.5 miles SW, is cliffy up to within 0.8 mile of the islet and then it becomes sandy.

Balandra Bay, entered close S of Islet a Bateau, has a sandy beach at the head. A black building, with a red roof, stands on its N shore. Small vessels with local knowledge can anchor, in a depth of about 5m, off the N shore of the bay.

**Saline Bay** (10°42'N., 61°01'W.), lying W of Fronton de Saline, provides shelter to small craft with local knowledge. A rocky islet, 12m high, fronts Fronton de Saline, 1.8 miles SW.

Matura Point, located at the base of the N range of mountains, is the termination of the rocky coast. A river discharges 1 mile SW of the point. The coast to the S consists of an almost straight, sandy shore lined with coconut palms. The sea breaks on this stretch with such violence that landing on any part of it is impracticable. The Oropuche River discharges 4.5 miles S of Matura Point.

Matura Bay lies S of Saline Bay and is entered between Matura Point and Manzanilla Point (10°31'N., 61°01'W.), 10 miles S. The coast between Matura Point and the Oropuche River consists of low red sand cliffs. Between the latter river and Manzanilla Point, the coast rises in a series of prominent cliffs, 15 to 24m high, which are streaked with red and white and backed by dense jungle. Several prominent wooded peaks stand within 12 miles WSW of Manzanilla Point.

**McMillan Rock** (10°37'N., 60°59'W.), with a least depth of 7.5m, lies about 2.5 miles E of the mouth of the Oropuche River. An isolated shoal, with a depth of 7.5m, lies about 1.3 miles SE of this rock.

**1.16 Manzanilla Bay** (10°30'N., 61°01'W.) is formed close W of Manzanilla Point. It consists of a small and sandy indentation protected on the E side by some rocky islets, up to 5m high. Two wedge-shaped rocks, 5m high, lie about 0.1 mile E of Manzanilla Point. A reef, which dries 0.3m, extends up to about 0.5 mile E of the point and breaks heavily. A light is displayed ESE of Brigand Hill.

**L'Ebranche Rocks** (10°30'N., 60°59'W.) lie on a shoal bank, 2.3 miles SE of Manzanilla Point. These rocks, which dry 1.2m, always break. A small rock, awash, lies near the extremity of the shoal bank, 0.8 mile W of the rocks. The bank, which usually breaks, extends up to 0.5 mile NE from L'Ebranche Rocks. Near its edge, the depths decrease suddenly from 20m to 4.5m.

Cocos Bay is formed between Manzanilla Point and Point Radix, 11.3 miles SSE, and encompasses Manzanilla Bay. Several rivers discharge into this bay. The Ortoire River, the largest in Trinidad, enters the bay close W of Radix Point. The shores of the bay are low and sandy. They are fringed with coconut palms which extend up to 0.5 mile offshore and make landing almost impossible. Anchorage can be taken, in a depth of 9m, mud, W of L'Ebranche Rocks and 1.8 miles SSW of Manzanilla Point.

**Radix Point** (10°20'N., 60°58'W.), a prominent headland, separates Cocos Bay from Mayaro Bay. It is 91m high, bold, radar conspicuous, and has high cliffs on three sides.

Mayaro Bay, a shallow indentation, is formed between Radix Point and Galeota Point, 12 miles SSW. The beach lying at the N end of this bay is sandy and fringed with coconut palms. A chapel, almost hidden by trees, stands on the coast, 5 miles SSW of Radix Point. From a point located 2 miles S of the chapel, the beach extending to Galeota Point is backed by cliffs, 6 to 12m high. These cliffs are densely wooded with an occasional tall palm.

Heavy breakers occur along the entire length of this part of the coast and prevent landing at any time. A strong S current sets inshore.

A prominent radio tower stands 6 miles N of Galeota Point.

Tourmaline Shoals encumber the N part of Mayaro Bay and form a bank of foul ground, with depths of 5.5 to 10m, which extends to within 2 miles of the shore. This bank extends to within 2.5 miles ENE of the chapel.

**Caution.**—An extensive oil and gas field, with production platforms, extends up to 22 miles ENE and 20 miles E of Galeota Point. Numerous submarine pipelines lie in this vicinity and extend between the platforms and Galeota Point. Another platform is reported to be situated about 30 miles ESE of Galeota Point. The northeasternmost group of platforms in the area are reported to be radar conspicuous. Anchorage is prohibited within 0.5 mile of the platforms.

A mud volcano, with a least depth of 1.8m, is located within an area bounded by a circle with a radius of 200m centered on position 10°22.7'N, 60°55.2'W. Mariners are advised to use caution and avoid the area.

**1.17 Galeota Point Terminal** (10°08'N., 60°59'W.) (World Port Index No. 11772), the SE extremity of Trinidad, is the site of an offshore terminal. The point is formed by a narrow promontory. Its outer end, which is 64m high, is connected to the mainland by lower land. The seaward side of the point is composed of white cone-shaped cliffs, which appear as islands from a distance. Three detached rocks, about 7m high, lie close off the SW side of the promontory. An area of foul ground extends up to about 0.5 mile SE of the point. The point should be given a wide berth as the current in this vicinity sets toward it. A lit superbuoy CALM lies about 2 miles SSE of Gran Cayo Point.

**Depths—Limitations.**—An SBM is moored in a depth of 29m about 2.5 miles SSW of Galeota Point. The buoy is 11m in diameter, marked by a light, and equipped with a radar reflector. It is connected to the shore by a submarine pipeline which extends NNE. The buoy is designed to handle tankers up to a maximum of 250,000 dwt.

Vessels bound for the terminal should pass E and S of the oil rigs in the area, E of Galeota Point, and then approach Galeota Point with a heading between 040° and 050°.

**Pilotage.**—Pilotage is compulsory. The pilot and loading master can be contacted by VHF and usually board about 3 or 4 miles SW of Galeota Point. Vessels should send an ETA at least 72 hours in advance and confirmation messages 24 hours and 12 hours before arrival. Vessels are normally berthed during daylight hours only.

**Anchorage.**—Anchorage is prohibited within 1 mile of the SBM and 0.5 mile of the submarine pipeline.

**1.18 Guayaguayare Bay** (10°08'N., 61°02'W.) is entered

between Galeota Point and Gran Cayo Point, 4.3 miles WSW. It is a sandy and shallow bight which affords shelter in the E part to small vessels with local knowledge. A jetty extends about 0.3 mile SW from the W side of Galeota Point and has a depth of 4m alongside its outer part.

Anchorage can be taken, in a depth of 8.2m, good holding ground, about 1 mile SW of Galeota Point.

In the channel leading between Trinidad and the mainland, S of Galeota Point, the W current attains a rate of 1.5 to 2 knots, increasing to 3 knots in the vicinity of Serpents Mouth.

The coast between Gran Cayo Point and Cape Casa Cruz, 6.5 miles WSW, is steep and rocky. It is fronted by shoals extending up to about 1 mile offshore in places. Trinity Hills, 304m high, rises about 0.8 mile inland.

From Cape Casa Cruz, the coast, which is steep with several slight indentations, trends 6 miles W to Moruga Point (10°05'N., 61°16'W.). Several sandy beaches fringe this stretch of the coast and are separated by projecting points, which are fronted by rocks. A light is located close NW of La Lune Point midway along this section of coast. The hills standing W of Trinity Hills gradually decrease in height. The Moruga River discharges close W of Moruga Point.

**1.19 Taparo Point** (10°04'N., 61°38'W.), marked by a light, is located 22 miles W of the Moruga River. This section of the coast is 31 to 46m high and covered by low shrubs. Occasional distinctive outcrops of yellow sandstone occur along this stretch. A number of prominent houses stand on the heights of Palo Seco Bay, 2.5 miles ENE of Taparo Point. Anchorage can be taken as convenient over a bottom of sand and mud anywhere off this coast between Moruga Point and Taparo Point. A moored storage tanker, with a racon, is located on the Venezuelan side of the channel opposite Palo Seco Bay.

Erin Bay (Herine Bay) is entered between Erin Point, located 1 mile W of Taparo Point, and Islote Point, 8 miles W. This bay may be identified by three conspicuous cliffs. Quoin Cliff rises 3 miles NW of Erin Point. It is 49m high, red, and wedge-shaped. A red cliff, 80m high, rises 2 miles W of Quoin Cliff. A white cliff, 23m high, rises 1.5 miles W of the red cliff.

La Fabiana, a prominent flat-topped hill, rises 2.5 miles N of Erin Point and is 117m high.

Erin Bay is bordered by a bank, with depths of less than 5m, which lies about 1.5 miles offshore. A reef lies on this bank, about 4.5 miles W of Erin Point. At times, a volcanic islet is reported to be formed on the reef. An isolated shoal bank, with a least depth of 7.3m, lies 3.8 miles S of the reef.

The coast between Islote Point and Punta del Arenal, 9 miles W, is low and sandy, except for some mud and clay cliffs rising 3.8 miles W of the former point.

Punta del Arenal is marked by a light; a dangerous wreck lies about 1.8 miles SE of it. A wreck, which dries, lies 1.5 miles SW of Galfa Point.

None of the bays formed between Taparo Point and Punta del Arenal provide shelter from the prevailing ESE wind, but the holding ground is good and anchorage may be taken as convenient.

## The Gulf of Paria

**1.20 The Gulf of Paria** (10°25'N., 61°48'W.), an extensive

body of water with moderate depths, is bordered on its E side by Trinidad and by the coast of Venezuela on its other sides. The gulf has two entrances. Dragons Mouth is the N and preferred entrance, and Serpents Mouth is the S entrance. Serpents Mouth, although not as safe as Dragons Mouth, is available to vessels of moderate draft. It is advisable to exercise extreme care when using this passage, especially at night.

Vessels proceeding to Port of Spain from the E save little time by using Serpents Mouth.

The ports within the gulf are important as transshipment centers for bauxite, iron ore, and petroleum products. Port of Spain, situated on the W side of Trinidad, is the principal commercial port. Chaguaramas Bay and Carenage Bays provide bauxite terminals. Pointe-a-Pierre, La Brea, Brighton, and Point Fortin are important oil terminals. Puerto de Hierro and Guiria are situated on the S side of the Peninsula de Paria. The latter port serves as a pilot station for vessels proceeding to the Venezuelan river ports of Caripito and Pedernales, situated in the SW part of the gulf.

**Depths—Limitations.**—The fairways of the channels leading through Dragons Mouth have general depths in excess of 20m. Boca Grande, the largest and W of the four channels, is the preferred channel.

Western Channel, the principal channel leading through Serpents Mouth, has depths of 11 to 22m in its central part, but is bordered by unmarked shoals on both sides of the fairway.

The central part of the gulf has depths of 18 to 37m, but its W part is shoal. The approaches to most of the ports and terminals have depths of less than 18m.

**Tides—Currents.**—A branch of the South Equatorial Current and the fresh water discharged from the tributaries of the Rio Orinoco enter the gulf through Serpents Mouth and control the general water movement within the gulf. During the flood season of the Rio Orinoco (May to October), fresh water flows in abundance into the gulf from these tributaries. It dilutes the sea making the surface water almost fresh and directs the currents toward the northernmost entrance.

Rates of 2 to 3 knots have been observed in March and April. During the rainy season, the strength of the current is probably greater by reason of the increased outflow from the Orinoco system. Off the Venezuelan coast from Punta Baja, the current sets W at a rate of 1 to 2 knots with no appreciable tidal effect.

Off Punta de Arenal, the surface currents set constantly NW at a rate of 1 to 3 knots and slacken at about the time of LW. A strong SE undercurrent has been observed to set below a depth of 9m. At the same time a SW current of yellowish muddy water, in contrast with the usual olive-green NW current, makes its appearance off Corral Point and passes S round the point, sometimes reaching as far as Wolf Rock. Vessels lying at anchor off Corral Point usually swing with their bows to the N until 2 to 3 hours after LW.

In Middle Channel, about halfway between Punta del Arenal and Soldado Rock, the currents set NW at 1.5 knots and the tidal currents NE and SW at 0.8 knot. The NE currents run for about 5 hours after the time of HW at Georgetown, Guiana.

To the NE of a line extending NW from Punta del Arenal, the currents are affected by the tides, both in direction and strength, and are irregular until NE of Los Gallos Point. To the NE of Los Gallos Point, the currents have been observed to be tidal with rates of 0.5 knot to 1.5 knots. The ebb current sets

NE for 9 hours after HW, and the flood SW for 3 hours before HW. Later observations give the same rates, but with the currents running for 6 hours after HW and LW, respectively.

In Western Channel, the NW currents attain rates of 3 to 4 knots over the shoals on the SW side of the channel.

The general current circulation within the gulf is N, emerging through Dragons Mouth. During the period of influx of fresh water from the Orinoco system, a compensating saline undercurrent enters through the Dragons Mouth setting S and SW. However, during the dry season, both the surface and under currents are directed N when the influx of fresh water decreases and the incoming saline undercurrent almost disappears.

Between Port of Spain and Brighton outside the 20m curve, the tidal currents are not well defined. During July and August, a SW current was observed running continuously for several days. At other times little or no current was observed in either direction. In the dry season (November to June), the tidal currents set S on the flood and N on the ebb. From June to November, the tidal currents are irregular, sometimes being reversed in direction, setting N or S continuously for days. At other times there is little or no current. These variations apparently depend upon the influx of the river systems, but cannot be predicted with any certainty.

On the E side of the gulf, the tidal currents from Dragons Mouth and Serpents Mouth meet just E of Brighton, but they are irregular. Between Brighton and Cedros Point in June and July, the currents setting SW and NE were observed to be stronger at neaps than at springs. Off Guapo Bay, these currents attain rates of 1 to 2 knots.

In the W part of the gulf, the tidal currents set between W and SW on the flood and between E and NE on the ebb.

Additional current data is given with the port information.

Off the northernmost entrance of the gulf, the N and NW tidal currents attain rates of 2 to 3 knots according to the season and the strength of the current and water levels of the Orinoco system. Between July and October, the influence may be felt 15 to 20 miles offshore. The water in the gulf for several miles outside this entrance has a muddy appearance, and in October the water becomes reddish in color.

The opposing tidal and ocean currents produce strong ripples, which from aloft may be seen extending in long curved lines for several miles outside the gulf, gradually approaching the entrance as the S flood increases its strength. In the entrance, these ripples often become a race, dangerous to boats.

In Boca Grande from July to October, the S tidal current runs for 4 hours at springs, but its rate seldom exceeds 0.5 knot as the N ocean current is then at its maximum strength, augmented by the influx of the swollen Orinoco system. During this period, the N tidal currents, accelerated by the ocean currents, run for 8 hours at a rate of 2 to 3 knots. From November to June, the tidal currents have more effect as the ocean current is then reduced, but they are at times variable due to various river levels. Strong rips occur in Boca Grande in the area of Isla Patos.

In Boca de Navios, the S flood current seldom exceeds 1 knot. The N ebb, accelerated by ocean currents, attains rates of 2.5 to 3.5 knots.

In Boca de Huevos, the N ocean currents are seldom offset by the S flood currents, except on the E side of Huevos Island. The ebb current attains a rate of 3 to 4 knots, and even as much

as 5 knots in the rainy season.

In Boca de Monos, there is no S current during the flood. Rates of 2 to 3 knots are attained during the N ebb current.

**Pilotage.**—Pilotage is compulsory for all ports and terminals on the W coast of Trinidad within the Gulf of Paria. This includes Chaguaramas Bay, Saint Peter's Bay, Grier Channel and basin at Port of Spain, the oil jetty at Pointe-a-Pierre, La Brea Pier, Brighton Pier, and Point Fortin Oil Pier.

Pilots from Port of Spain will, if required, board vessels outside of the above port areas, including Dragons Mouth, provided prior notice has been sent by radio.

Pilotage is compulsory for vessels proceeding to the Venezuelan river ports and pilots must be embarked at Guiria.

Additional pilotage information is given with each port description.

**Caution.**—Oil wells and drilling platforms form a serious hazard to navigation within the gulf. Some platforms are moved frequently and Notice to Mariners should be consulted.

Extreme care is advised when navigating within the gulf as the newly erected platforms may not be charted. Vessels should make every effort to obtain the latest corrected charts of the area prior to entry.

High speed craft operate between Scarborough, Tobago and Port of Spain, Trinidad. Mariners are advised to maintain a good lookout. Some high speed craft generate large waves, which can have a serious impact on small craft and their moorings close to the shoreline and on shallow off-lying banks.

## Dragons Mouth

**1.21 Dragons Mouth** (10°42'N., 61°45'W.), the N entrance to the Gulf of Paria, is formed between Entrada Point, the NW extremity of Trinidad, and Punta Penas, the NE extremity of Venezuela.

Dragons Mouth is divided into four channels by three islands which, from E to W, are Monos Island, Huevos Island, and Chacachacare Island.

**Boca de Monos** (10°42'N., 61°40'W.) is formed between Trinidad and Monos Island, 0.5 mile W. The island is thickly wooded and 287m high. The fairway channel of Boca de Monos is about 0.2 mile wide. Strong and irregular eddies occur off the points and this passage is not recommended.

Le Chapeau, marked by a light, lies 0.1 mile NE of Monos Island, on the W side of the N entrance to Boca de Monos. A spit, with a depth of less than 1.2m, extends up to about 0.1 mile SE from the SE extremity of Monos Island.

**Caution.**—A dumping ground for explosives, which may best be seen on the chart, lies centered 3.5 miles E of Punta Penas.

**1.22 Boca de Huevos** (10°41'N., 61°42'W.) is about 0.8 mile wide and deep. This channel separates Monos Island from Huevos Island, which is the smallest and central of the islands forming Dragons Mouth.

Huevos Island, divided into two parts by Boca Sin Entrada, is joined near its center by a narrow neck of drying sand. A rock, 27m high, lies close off the NE extremity of Huevos and foul ground, with depths of less than 1.8m, extends up to about 0.1 mile E of its E extremity. A light is shown from the S extremity of the island.



**Chacachacare Light**

**Chacachacare Island** (10°41'N., 61°45'W.), thickly wooded, is connected near its center by a low isthmus. Boca de Navios, a deep and clear channel, is about 0.8 mile wide and leads between the S extremity of Huevos Island and the E extremity of Chacachacare Island.

The NE side of Chacachacare Island between La Lue Point and Point Girod, 1.8 miles SE, rises abruptly to heights of 183 to 240m. Point Girod is composed of prominent, red cliffs. The SW extremity of the island terminates in a perpendicular cliff, 126m high.

**1.23 Diamond Rock** (10°40'N., 61°46'W.), composed of coral, lies about 0.3 mile W of the SW extremity of Chacachacare Island and a lighted buoy is moored close W of it. This buoy was reported (1997) to be missing. The rock is steep-to and has a least depth of 1.8m. The other dangers that fringe the coasts of the island lie no more than 0.1 mile offshore.

Chacachacare Bay, on the E side of the island, is entered between Point Girod and Point Romain, 0.8 mile SW. Vessels may anchor, in depths of 24 to 29m, mud, within the bay. Vessels approaching this anchorage from the S should favor Point Romain until within the bay as a strong current sets NE across the entrance.

**Boca Grande** (10°42'N., 61°48'W.), the principal channel leading into the Gulf of Paria, is about 5.8 miles wide between the NW extremity of Chacachacare Island and Punta Penas. In general, the depths in the channel are over 16m. However, a shoal, with a least depth of 14.3m, lies near the middle of the channel, 2.8 miles W of Chacachacare Island.

Promontorio de Paria, rising on the W side of the Dragons Mouth, is 299m high and appears as an island from a distance to the NW or SE. La Islette, a small islet, is 70m high and lies close N of the N extremity of the promontory. A rock, awash, lies about 0.3 mile NE of Punta Penas and tide rips form in its

vicinity.

Punta Cerezo, 134m high, is located on the Venezuelan coast, 2.5 miles SSW of Punta Penas.

**Caution.**—A dumping ground area, which may best be seen on the chart, has been established for both wrecks and explosives off the SE coast of Chacachacare Island.

**1.24 Garza Rocks** (10°41'N., 61°53'W.) lie close together 0.3 mile offshore, about 0.8 mile SSW of Punta Cerezo. The largest rock in this group is 66m high.

From close W of Garza Rocks, the coast extends 1 mile SSW to Punta Garcitas, which rises to a height of 342m about 0.5 mile N. Several red cliffs stand between Punta Penas and Punta Garcitas.

**Isla Patos** (10°38'N., 61°52'W.), a thickly-wooded islet, lies 2.5 miles SSE of Punta Garcitas. This islet is 100m high and marked by a light. A racon is situated at the light structure. A flagstaff surmounts a summit in the W part of the islet.

Strong tide rips are usually encountered about 0.5 mile S of the SE extremity of the islet and about 2 miles NE of the same extremity.

**Caution.**—Several oil platforms are situated 13 miles S of Isla Patos. Due to the many obstructions, wells, rigs, and submerged pipelines in the vicinity, vessels are advised to avoid the area whenever possible.

Deep-draft vessels entering Boca Grande should transit in the designated area as indicated on the chart.

## Serpents Mouth

**1.25 Serpents Mouth**, the S entrance to the Gulf of Paria, is approached between the S coast of Trinidad and the shoals extending about 4 miles off the coast of Venezuela.

**Icacos Point** (10°04'N., 61°54'W.), the SW extremity of Trinidad, is low, flat, and forms the N entrance point of Serpents Mouth. Punta del Arenal is the SW extremity of this point and Corral Point is located 1 mile N of it.

Serpents Mouth, though not as safe as Dragons Mouth, is accessible by day to vessels of moderate size and draft. Vessels proceeding from Port of Spain to Demerara will shorten the time taken for the passage by avoiding much of the adverse current encountered when taking the usual route around the N and E sides of Trinidad, although the distance is about the same. At night, this passage through Serpents Mouth can be dangerous. The currents are strong and variable, and must be avoided, particularly during the rainy season, between the middle of April and the middle of October. Continuous monitoring of the vessel's position is absolutely necessary.

**1.26 Green Hill** (10°04'N., 61°52'W.), 65m high, is located 4.3 miles ENE of Punta del Arenal; a beacon, 34m high, stands close NE of it. This hill and the beacon are conspicuous when approaching Serpents Mouth from the E.

From Punta del Arenal, the coast of Icacos Point extends 1 mile N to Corral Point and then 1.8 miles NE to Los Gallos Point. The latter point is yellow, cliffy, and 18m high. The coast between Corral Point and Los Gallos Point is fringed by a bank, with depths of less than 5.5m which extends up to about 0.8 mile offshore. During N winds, the sea breaks a considerable distance offshore in this area.

Los Gallos Rocks, up to 15m high, extend up to about 0.2 mile W from the point and are marked by a lighted buoy moored 1 mile W.

A bank, with depths of less than 20m, extends up to about 6.8 miles W from Punta del Arenal. A number of above-water rocks and shoal patches, with depths of less than 5m, lie within the limits of this bank.

**Soldado Rock** (10°04'N., 62°01'W.), 36m high, lies on the bank, about 5.3 miles WNW of Corral Point. It is marked by a light and appears like a sail from a distance. Pelican Rocks and Southeast Rocks, similar groups about 2m high, lie 1 mile S and 0.8 mile SSE, respectively, of Soldado Rock.

A detached shoal, with a least depth of 4.7m, lies on the SW side of Western Channel, 3.4 miles WSW of Pelican Rocks.

Southeast Ledge, an isolated shoal with a least depth of 3.7m, lies about 2 miles SE of Soldado Rock.

**Three Fathom Bank** (10°03'N., 61°57'W.), with a least depth of 3.4m, lies 0.3 mile W of Corral Point. Wolf Rock, with a depth of 1.2m, lies 0.4 mile NW of Punta del Arenal Light. Demerara Shoal, with a depth of 4.6m, lies 1 mile N of the light.

An isolated patch, with a depth of 3.4m, lies about 0.5 mile NW of Demerara Shoal. The positions of other shoal patches within the Three Fathom Bank area may best be seen on the chart.

Access to the Gulf of Paria from Serpents Mouth may be made through Eastern Channel, Second Channel, Middle Channel, or Western Channel described below in paragraph 1.27. Vessels other than those of shallow draft should avoid the shoal, with a depth of 7.3m, lying 5.5 miles SW of Erin Point. A dangerous wreck lies 1.8 miles SE of Punta del Arenal Light and should also be avoided.

**1.27 Eastern Channel** (10°02'N., 61°56'W.), entered between Punta del Arenal and Wolf Rock, has a least depth of 6.1m.

Second Channel, lying between Wolf Rock and Three Fathom Bank, leads either E or W of Demerara Shoal. This channel has a least depth of 7m in its entrance, but vessels with drafts of up to 7.6m can transit through it.

Middle Channel leads between Three Fathom Bank and the shoals lying SE of Soldado Rock. This channel has a least depth of 5.8m, but vessels with drafts of up to 7.9m can make the transit.

Western Channel leads between the shoal patches lying SW of Pelican Rocks and the shoals fronting the coast of Venezuela. This channel is wide and deep, but it must be used with caution as the NW currents run at rates of 3 to 4 knots, at times, over the dangerous patches on its SW side.

**Directions.**—Approaching Serpents Mouth from the E, the S coast of Trinidad should be favored to avoid the incompletely surveyed coast of Venezuela, where uncharted dangers may exist.

Having passed Galeota Point, vessels should keep about 3 miles off the coast of Trinidad and in depths of 18 to 27m until SW of Erin Point, where depths on the N side of the fairway decrease to 9 to 11m.

Eastern Channel should be entered by rounding Punta del Arenal at a distance of 0.2 mile, passing midway between the point and Wolf Rock, and then passing E of Demerara Shoal.

Punta del Arenal should not be brought to bear more than 166° until vessels have cleared the 5m curve, W of Icacos Point. This channel is narrow and may be partially obstructed by vessels at anchor.

**1.28 Middle Channel** is the one most generally used for vessels with suitable draft. After rounding Punta del Arenal at a distance of 0.5 to 1 mile, vessels should steer for Soldado Rock until Cedros Point is in line with the outermost of the Los Gallos Rocks, bearing 061°. Then, allowing for the current, vessels should steer to make good a course of about 342°. They should proceed, passing midway between the lighted buoy marking Three Fathom Bank and the lighted buoy moored 1.3 miles WNW, until clear of all dangers to the N of Soldado Rock.

Vessels of light draft with local knowledge may, in fair weather, cross the outer part of the bank, with depths of less than 9m, lying NW of Icacos Point when Los Gallos Rocks bear more than 090°.

**Anchorage.**—Good anchorage can be taken between Icacos Point and Soldado Rock in convenient depths. The only place smooth water can be depended upon, if there is wind, is under the lee of Icacos Point, between Punta del Arenal and Corral Point.

**Caution.**—Soldado Marine Oil Field lies NE of the termination of the above directions. Navigation is restricted within the limits of this oil field and vessels are advised not to approach within the area bound by Lighted Buoy A through Lighted Buoy E.

It was reported (1997) that Lighted Buoy A through Lighted Buoy E were missing. Numerous other buoys marking dangers in this area were also reported (1997) to be missing.

## Trinidad—West Coast—Entrada Point to Port of Spain

**1.29** From Entrada Point, the W coast of Trinidad trends 1.8 miles S to Punta Delgado and forms the E side of Boca de Monos.

From **Punta Delgado** (10°41'N., 61°40'W.), the coast trends 2 miles E to Point Gourde and then continues 6 miles E to Port of Spain. Point Gourde is formed by a peninsula, 141m high.

Teteron Rock, which dries 0.9m, lies close W of Punta Delgado and is marked by a light.

**Gasparillo Islet** (10°40'N., 61°39'W.), 42m high and marked by a light on its SW extremity, lies close S of San Jose Point, 0.8 miles SE of Punta Delgado. A shoal, with a depth of 8.8m, lies about 0.2 mile ENE of this islet.

Gaspar Grande Island, 103m high, lies 0.5 mile S of Gasparillo Islet; its W end is located 1 mile S of Punta Delgado. Scorpion Ledge, with a depth of 3m over its extremity, extends up to about 0.2 mile seaward from the SE side of the island. The channel leading between Gasparillo Islet and Gaspar Grande Island has depths of 31 to 48m. The channel lying E of the island has depths of 31 to 37m and is clear, except for Scorpion Ledge. Lights are displayed at Epsolon Point, near the SW extremity of the island, and at Reyna Point, the NW extremity.



**Teteron Rock Light near Punta Delgado**



**Chaguaramas Bay (aerial from E to W)**



**Epsolon Point Light**



**Chaguaramas Terminal Wharf (center)**



**Reyna Point Light**

### **Chaguaramas Bay (10°41'N., 61°39'W.)**

World Port Index No. 11710

**1.30** Chaguaramas Bay is entered between San Jose Point and San Carlos Point, 1.3 miles SE. The port area consists of a coastal natural harbor which is protected on the E side by Point Gourde. A bauxite terminal is situated on the E side of the bay and naval facilities stand on the N side of the bay.

**Tides—Currents.**—The flood current flows through Boca de Monos, E around Punta Delgado, and then between Gaspar Grande Island and the coast of Trinidad.

The current strikes the W side of Point Gourde and is deflected Pier No. 4 and Pier No. 5, and in the bay to the W of them. This portion of the current is weak and confined to an area close to the shore. The ebb current flows W between Gaspar Grande Island and Trinidad, and then N through Boca de Monos. Eddies are caused in the bay to the W of Pier No. 4 and Pier No. 5, as a portion of the current is deflected N by Gasparillo Islet. As this current weakens and the S current builds up at the N end of Boca de Monos, a tidal surge, known locally as the Re-Mou, sometimes occurs. It moves E through the channel N of Gaspar Grande Island and is clearly visible as a marked line on the surface.

The Re-Mou arrives in Chaguaramas Bay between 30 minutes and 1 hour after local LW and runs for 20 to 30 minutes. It is irregular in occurrence and erratic in rate, varying between 1 and 5 knots. In general, the surge is strongest in July and August and weakest in January through March, though maximum rates can occur at any season. As soon as the Re-Mou has dissipated, the tidal current settles to its normal rate.

**Depths—Limitations.**—The Bay contains a repair yard for commercial vessels and is a supply base for the offshore oil and gas industries. For berthing information, see the table titled **Chaguaramas—Berth Information**.

Chaguaramas—Berth Information			
Berth	Length	Depth	Remarks
<b>Carib Dockyard</b>			
No. 4	150m	12.0m	Located in the repair yard N side of bay
No. 5	150m	12.0m	Located in the repair yard N side of bay
Quay	—	7.0m	Located in the repair yard
<b>Chaguaramas Terminal</b>			
Berth	274m	10.5m	Can accommodate vessels up to 30,000 gross tons
<b>Tanker Berth</b>			
Wharf	60m	6.0m	Petroleum
<b>Salt Jetty</b>			
No. 1	58m	8.0m	—
No. 2	58m	8.0m	—

**Pilotage.**—Pilotage is compulsory for vessels using the piers or wharves. Pilots can be contacted on VHF channels 12 and 16 and board about 1 mile S of Cronstadt Islet. Vessels should send a request for pilotage and an ETA 72 hours, 48 hours, and 24 hours in advance.

**Anchorage.**—Authorized vessels can anchor, in a depth of 26m, about 0.5 mile N of the E extremity of Gaspar Grande Island. However, this berth is not advisable due to strong currents. In addition, numerous other vessels are generally

anchored in the vicinity. The safest and best anchorage for vessels awaiting repairs is located about 1.5 miles S of Cronstadt Islet, situated S of Point Gourde.

**Caution.**—A wreck has been reported (2009) about 0.3 mile S of Chaguaramas near a buoy W of the N point of Escondida Cove.



**Escondida Point Light**

It was reported (2008) that an uncharted wreck lies 0.5 mile NE of Reyna Point and is marked by a buoy and a wooden floating dock.

**1.31** The **Diego Islands** (10°39'N., 61°38'W.), consisting of Cronstadt Islet and Carrera Islet, lie 0.4 mile S of Point Gourde. Some prominent buildings stand on both islets.

**Depths—Limitations.**—A quay, 61m long, fronts the W side of Cronstadt Islet and has a depth of 13.7m alongside. Vessels of up to 122m in length can berth at this quay by overhanging each end.

A penal colony is situated on Carrera Islet.

The intervening channel leading between the islets and Point Gourde is deep and clear of dangers.

**Pilotage.**—Pilotage is compulsory to the quay and berthing is carried out during daylight only. The pilot usually boards about 0.5 mile SW of the pier head.

**Caution.**—Submarine cables connect Carrera Islet, Cronstadt Islet, and Point Gourde.

**1.32** The **Five Islands** (Las Cotorras) (Quarantine Islands) (10°39'N., 61°36'W.) are in reality six islets. However, Craig Islet, the smallest, is joined to Caledonia Islet, the largest, by a narrow drying reef. This group lies 1.3 miles E of Carrera Islet on two detached shoals, with depths of less than 5m. Caledonia Islet, the N, is 25m high, and Nelson Islet, the S, is 11m high. Buildings stand on all these islets except one.

**Carenage Bay** (Tembladora) (10°41'N., 61°36'W.) lies between Alice Point, the E extremity of Point Gourde, and Point Sinet, located on the mainland 1 mile ENE. An extensive shoal, with depths of 2.1 to 5.5m, lies with its SW extremity located 0.4 mile NE of Alice Point.

**Depths—Limitations.**—Pier No. 1 has collapsed and constitutes an obstruction to navigation. Pier No. 2 is in ruins and its range marks have been discontinued.

A bauxite plant stands close E of Point Sinet; a pier projects S from the shore in its vicinity. It is 297m long on the W side and 206m long on the E side. The berth on the W side is for loading and the berth on the E side is for discharging. Vessels

of up to 35,000 dwt and 7m draft can be accommodated. Pilotage is compulsory. A 36 and 24 hour notification prior to arrival is required. Pilots are contacted on VHF Channels 16 and 12.

A lighted range, bearing 042°14', indicates the channel, dredged to a depth of 11m, leading to the berths. A conspicuous tank stands 0.1 mile NNW of the rear range structure.

**Caution.**—A submarine cable extends E, parallel to the shore, and crosses under the pier close to its head.

At times, the range lights may be difficult to distinguish because of thick bauxite dust.

**Martin Point** (10°40'N., 61°34'W.), located 2.3 miles ESE of the bauxite plant, lies at the W limit of Port of Spain. A bay lies between Martin Point and the mouth of the Maraval River.

### Port of Spain (10°39'N., 61°31'W.)

World Port Index No. 11720

**1.33** Port of Spain is a natural coastal port situated in the NE corner of the Gulf of Paria. It is the principal port for vessels in Trinidad and one of the most important ports in the

West Indies. Ample berthing spaces are provided for all classes of vessels.

The city is the capital and the seat of Government of Trinidad and Tobago.

#### Port of Spain Home Page

<http://www.patnt.com>

**Winds—Weather.**—The prevailing winds are from the E; however, strong W winds accompanied by rough seas may occur without warning from July to October. The E winds overcome the effect of the tidal currents and the current setting out of the Rio Caroni, so that vessels in the roadstead usually lie heading E.

**Tides—Currents.**—The tides rise 1.2m at springs and 0.9m at neaps.

The flood tidal current sets SE at a rate of 0.5 knot and the ebb current sets in the reverse direction at the same rate. About 4 miles SW of the harbor area, the currents have been found to be irregular and of considerable strength.

#### Port of Spain—Main Berthing Limitations

Berth	Length	Draft	Remarks
Caricorn Jetty	248m	5.0m	Caricorn cargo.
Catwalk (GSS)	107m	6.0m	Interisland ferries.
St. Vincent Jetty	119m	6.0m	Tugs and dredges.
Slipway Guide Jetty	215m	—	On lease for slipway operations.
<b>Kings Wharf</b>			
No. 1	198m	9.7m	Cruise ships. Can accommodate vessels up to 270m loa.
No. 2	152m	9.7m	—
No. 3	161m	9.7m	Multi-purpose.
No. 4	161m	10.0m	Multi-purpose.
No. 5	185m	10.0m	Containers. Can accommodate vessels up to 245m loa.
No. 6	135m	10.0m	Containers.
No. 6A (east)	179m	12.0m	Containers. Can accommodate Post Panamax vessels up to 245m loa.
No. 6A (west)	170m	12.0m	Containers.
No. 7	143m	12.0m	Containers.
No. 8	194m	9.5m	Dry bulk.
No. 8A (west)	72m	4.0m	Dry bulk.
<b>Caricom Wharves</b>			
East-West	160m	6.5m	Caricom vessels under 500 gross tons.
North-South	155m	6.5m	Caricom vessels under 500 gross tons.
Bans Dock	85m	4.0m	Steel scrap.
National Fisheries	61m	5.0m	Deep-sea fishing vessels.
National Petroleum	304m	6.1m	LPG and refined oil products.



**Depths—Limitations.**—The city and the harbor area are fronted by a shore bank with depths of less than 5m.

Grier Channel, 165m wide, has a least depth of 9.8m and leads through the shore bank to a basin fronting Kings Wharf and Kings Wharf extension there are eight berths, numbered 1 through 8 from SE to NW. This basin has general depths of 9.5 to 10.2m. For berthing information see the table titled **Port of Spain—Main Berthing Limitations**.

**Aspect.**—The city is built on the shore at the S extremity of a flat plain, at the base of the Saint Ann Mountains. These mountains, up to 620m high, stand 3 miles NE of the city. The Laventille Hills stand 0.5 mile E of the center of the city. A conspicuous church is situated 0.5 mile S of these hills and Fort Picton stands 0.2 mile SSW of it.

Other conspicuous landmarks include the radio towers situated close N of Saint Vincent Jetty, the chimneys standing about 0.7 mile NW of the same jetty, and the Fort George signal station situated NW of the town.

Grier Channel is indicated by a lighted range and marked by lighted buoys. It leads ENE into Grier Basin and has been dredged (2002) to 12m. Sea Lots Channel is marked by lighted beacons and indicated by a lighted range.

Several mooring buoys are situated about 0.5 mile SSW of Saint Vincent jetty.



Port of Spain—aerial view



Port of Spain, Trinidad

**Pilotage.**—Pilotage is compulsory from 0.5 mile seaward of the dredged channel to the berths. Vessels should send an ETA



Port of Spain—Kings Wharf

48 hours and 24 hours in advance through North Post Coast Radio Station. Pilots board about 0.5 mile seaward of the entrance to Grier Channel. Pilots for Sea Lots Channel board about 0.1 mile W of the entrance lighted beacons.

**Contact Information.**—The pilots can be contacted, as follows:

1. VHF: VHF channels 12 and 16
2. Telephone: 1-868-627-7222  
1-868-625-1144  
1-868-623-4364
3. Facsimile: 1-868-624-7470
4. E-mail: [info@ttmarinepilots.com](mailto:info@ttmarinepilots.com)

**Anchorage.**—Vessels may anchor as convenient, in depths of 5.5 to 11m, stiff mud, anywhere off the city. Vessels should not anchor within 0.1 mile of the center lines of the channels to avoid obscuring the lighted buoys and beacons. In addition, vessels should not anchor within 0.5 mile of the channel entrances.

**Caution.**—The Grier Channel range lights are often obscured by smoke.

Several wrecks and submerged obstructions, which may best be seen on the chart, lie in the basin and in the vicinity of the channels. Several wrecks lie near W of the two mooring buoys positioned N of Sea Lots channel.

An explosives anchorage area, the limits of which are indicated on the chart, lies close S of the entrance to Sea Lots Channel. Several stranded wrecks and obstructions, some with depths of as little as 3.8m, lie within this explosives anchorage and may best be seen on the chart.

A floating pontoon, marked by a light, has replaced Immigration Jetty close NW of Jetty Head.

A spoil ground area, with a least depth of 4.2m, lies close N of Grier Channel. Vessels with drafts of more than 3m are advised not to navigate through this area.

A ferry service operates between Port of Spain and San Fernando between the hours of 0530 and 2000 local time, Monday through Friday. Mariners are requested to give the ferries a wide berth, and exercise caution during the period of operation.

**Port of Spain to San Fernando**

**1.34** The coast between Port of Spain and **Cangrejos Point** (10°26'N., 61°30'W.), 13.5 miles S, is low and swampy. It is fronted by a mud flat, with depths of less than 5m, which extends up to 2 miles offshore. Three shallow rivers, which drain the swampy land, discharge within 7 miles S of Port of Spain. Barrancones Point, located 8.5 miles SSE of Port of Spain, is low, but a conspicuous chimney stands 1.8 miles S of it. About 1.5 miles N of Cangrejos Point, a few small cliffs may be seen through the mangroves.

Cangrejos Point is not easily identified, but two conspicuous white chimneys stand 2.5 miles ESE of it. Another group of chimneys stands about 0.5 mile S of the two white chimneys.

**Savonetta Point** (10°25'N., 61°30'W.) is located 1 mile S of Cangrejos Point. It is reported that vessels load sugar from lighters off this point.

Lisas Bay is entered between Savonetta Point and Lisas Point (10°23'N., 61°29'W.), 2 miles S. This bay is fringed by a drying bank extending up to about 0.5 mile offshore. Depths of 5.5m lie up to 1.5 miles W of Lisas Point.

Claxton Bay, a shallow indentation, is formed between Lisas Point and Pointe-a-Pierre, 3.3 miles SSE.

**Caution.**—An oil production platform is situated about 5 miles NW of Cangrejos Point.

**1.35 Point Lisas Industrial Port** (10°24'N., 61°30'W.) (World Port Index No. 11750) is divided into three operational areas. Specialized bulk cargo is handled at the NW section of the port area. In addition, there are facilities for ammonia, urea, methanol, and base oil products. The third operational area comprises docking for container, ro-ro, and general cargo vessels.

**Depths—Limitations.**—Savonetta Channel, which leads for 2 miles through the shore bank to a turning basin, is 152m wide and dredged to a depth of 12.8m. The turning basin is also dredged to a depth of 12.8m.

A jetty, with a dolphin at its SE end, is situated on the NE side of the basin and provides a bulk cargo berth for the steel works. A small jetty used by tugs is situated in the N corner of the basin.

The container and ro-ro berths can handle vessels of up to 170m in length and 7.8m draft.

Vessels of up to 75,000 dwt, 243m in length, and 11.5m draft can be accommodated at the port at LW, allowing for a 10 per cent underkeel clearance. For further information, see the table titled **Point Lisas Industrial Port—Berth Information**.



**Point Lisas Port (partial)**



**Point Lisas Port (partial)**

**Aspect.**—A lighted range, bearing 052°16', indicates the channel leading through the shore bank to the turning basin.

A prominent steel plant stands about 0.3 mile inland from the port.

**Pilotage.**—Pilotage is compulsory. Pilots can be contacted by VHF and boards the entrance to the Savonetta channel. Vessels should send an ETA together with a request for pilot 5 days, 4 days, 3 days, 48 hours, 24 hours, and 12 hours prior to arrival.

<b>Point Lisas Industrial Port—Berth Information</b>				
<b>Berth</b>	<b>Length</b>	<b>Maximum vessel</b>		<b>Remarks</b>
		<b>Length</b>	<b>Draft</b>	
Savonetta Pier No. 1 North	115m	115m	7.0m	Bulk lube oil and additives.
Savonetta Pier No. 1 South	310m	240m	11.5m	Anhydrous ammonia, urea, and methanol.
Savonetta Pier No. 2 (SP2S)	312m	190m	11.5m	Can accommodate vessels up to 42,000 dwt. Bulk ammonia and methanol.
Savonetta Pier No. 2 (SP2N)	—	190m	11.5m	Can accommodate vessels up to 42,000 dwt. Bulk ammonia and methanol.

Point Lisas Industrial Port—Berth Information				
Berth	Length	Maximum vessel		Remarks
		Length	Draft	
Savonetta Pier No. 4 (SP4)	380m	245m	11.5m	Export ammonia and methanol.
Iron Carbide Dock (ISPAT)	407m	245m	11.6m	Iron ore and steel products.
Berth No. 1	35m	25m	5.0m	General, break bulk, and ro-ro barges.
Berth No. 1A	30m	100m	6.6m	General, break bulk, ro-ro, and lo-lo.
Berth No. 2	165m	70m	4.5m	General and break bulk.
Berth No. 3	105m	135m	7.2m	General, break bulk, ro-ro, and lo-lo.
Berth No. 4	110m	170m	7.8m	General, break bulk, ro-ro, and lo-lo.
Berth No. 5	200m	—	11.6m	General, containers, break bulk, ro-ro, and lo-lo.
ISCOTT Bulk Terminal				
Bulk Terminal	407m	245m	11.6m	Iron ore, DRI, and steel products.

**Anchorage.**—Anchorage areas for inbound and outbound vessels are situated NW of the channel entrance. When the port is congested, vessels may be requested to anchor at Port of Spain Roadstead before proceeding to Point Lisas Industrial Port.

**1.36 Lisas Point Port** (10°23'N., 61°29'W.) is located S of Point Lisas Industrial Port and should not be confused with the latter. This is a Hydro-Agri port formerly known as Fedchem, Point Lisa.

**Depths—Limitations.**—The port is entered through a 250m wide approach channel using lighted beacons in line 091°20' as lead marks. The channel is dredged to 12.8m up to the Tringen deep water terminal and turning basin. Thereafter the channel is dredged to 8.8m to the inner berths and turning basin.

Tringen II provides berths for loading ammonia on the N side of the entrance to the inner channel and Hydro-Agri Turning Basin. The terminal can accommodate vessels of 220m length and 11.6m draft.

Jetty No. 1, in the inner harbor on the N side, can accommodate vessels of 170m length and 8.7m draft. This berth is for loading butane and natural gas.

Jetty No. 2, in the inner harbor on the foreshore, can accommodate vessels of 171m overall length and 8.7m draft. This berth handles ammonia, molassas, bulk sugar, sulphuric acid, caustic soda, and voranol.

A Deep-water Terminal is situated on the S side of the entrance to the port. This terminal can accommodate vessels with a maximum loa of 230m.

**Pilotage.**—Pilotage is compulsory. Vessels should send

their ETA 48 hours, 24 hours, and 12 hours in advance of arrival. Pilots board at the entrance to the Lisas Point approach channel.

**Anchorage.**—Anchorage areas for inbound and outbound vessels is found as charted S of the entrance channel.

**1.37 Claxton Bay Marine Terminal** (10°21'N., 61°28'W.) is situated 1.5 miles N of Pointe-a-Pierre and is used for loading cement. The terminal is approached through a channel dredged to a depth of 6.4m (1985). This channel is marked by lighted beacons and leads to a turning basin. A lighted range, bearing 081°25', indicates the fairway leading to a loading pier and a ro-ro berth, at the E end of the basin. It is reported that pilots for this terminal can be embarked at Lisas Point Port.

**Caution.**—From a point on the shore located 0.2 mile S of the rear range light, a disused submarine pipeline, which may best be seen on the chart, extends about 1 mile seaward and parallels the dredged channel.

### Pointe-a-Pierre (10°19'N., 61°28'W.)

World Port Index No. 11730

**1.38** Pointe-a-Pierre is an open roadstead, with several berths and terminals for tankers.

**Pointe-a-Pierre Home Page**

<http://www.petrotin.com>

Pointe-a-Pierre—Berthing Limitations					
Berth	Length	Maximum Vessel			Remarks
		Size	LOA	Draft	
Viaduct Jetty (South Jetty)					
No. 1	47m	50,000 dwt	220m	11.8m	Petroleum products.

Pointe-a-Pierre—Berthing Limitations					
Berth	Length	Maximum Vessel			Remarks
		Size	LOA	Draft	
No. 2N	61m	63,000 dwt	236m	11.8m	Petroleum products and LPG.
No. 2S	23.1m	7,000 dwt	107m	7.0m	Petroleum products and LPG.
No. 3N	182m	45,000 dwt		10.3m	
Sea Island					
No. 5	68.2m	100,000 dwt	274m	12.5m	Petroleum products.
No. 6	97.5m	120,000 dwt	290m	15.8m	Petroleum products.
North Jetty					
No. 7 (inner)	213m	35,000 dwt		10.3m	Petroleum products and kerosene.
No. 7 (outer)	213m	35,000 dwt		10.3m	Petroleum products and kerosene.
Cargo Berths					
No. 8N	174m	25,000 dwt		8.7m	
No. 8S	79m	5,500 dwt		6.6m	
Sulphur Berth	174m	25,000 dwt		7.0m	

**Winds—Weather.**—From January to March, NE or E by NE winds predominate. They are at their strongest, averaging 12 to 15 knots. From August to October, the winds, although variable, are mainly E or SE and are at their weakest, averaging 7 to 8 knots. In other months, the winds tend to be intermediate both in direction and force between the values quoted for spring and autumn.

Squalls of varying intensity are common during the seasonal torrential rains from June to October. These rain squalls are often accompanied by sudden shifts in wind direction.

The hurricane season is from the beginning of August to mid-September, but they may occur as early as June or as late as November. It is unusual for the coasts of Trinidad to be directly affected by these hurricanes, although, they may experience heavy swells and sometimes rough seas when a hurricane crosses to the N of the island.

**Tides—Currents.**—Off the pipeline jetty, both the N and S tidal currents attain rates of 0.5 to 1 knot. Outside the 20m curve, the tidal currents are not well defined. During the months of July and August, a SW current was observed running continuously for several days, while at other times there was little or no current either way.

The tidal currents between November and June set S on the flood and N on the ebb, with rates of 0.5 to 1 knot. Between June and November, the tidal currents are irregular and may set N or S for several days with rates considerably in excess of the average on occasions, but at certain times they are nonexistent.

**Depths—Limitations.**—The berthing facilities consist of two jetties and two offshore island berths, connected by pipeline with the S jetty, which extends from the shore. All of these facilities are served by several oil terminals and can accommodate a number of tankers simultaneously.

The main, or N jetty, is about 0.5 mile long and extends WNW from the shore. The S jetty, is a viaduct supported on piles, has dolphin-type Berth. The main channel has a controlling depth of 12.4m.

The berthing limitations are given in the accompanying table titled **Pointe-a-Pierre—Berthing Limitations**.

An SPM is moored 3.3 miles WNW of the N jetty in a depth of 24m. It can accommodate vessels of up to 285,000 dwt and 22.4m draft.

**Aspect.**—Naparima Hill, 177m high, rises 2.5 miles S of the root of the N jetty at Pointe-a-Pierre and is conspicuous. A conspicuous water tank stands about 0.5 mile ENE of Pointe-a-Pierre. Three chimneys, each 81m high, stand 1 mile SE of the water tank; a similar chimney, 80m high, is situated 1 mile WSW of them.

The hills which extend NE from Pointe-a-Pierre have been reported to be radar conspicuous.

The oil terminals are not clearly visible from a distance, but the landmarks may be useful.

**Pilotage.**—Pilotage is compulsory. The pilot boards near 10°19'N, 61°30'W, approximately 1 mile W of the main jetty head at Pointe-a-Pierre and for all berthing and unberthing, including passage to the SPM.

Vessels using the berths embark pilots about 1.4 miles SE of the SPM.

Vessels proceeding to the SPM usually embark pilots about 2 miles W of it. Vessels must keep their engines at immediate readiness while at the buoy.

**Regulations.**—Vessels should send an ETA via the agents 72 hours, 48 hours, and 24 hours in advance. If the ETA changes by more than 2 hours, an amended ETA message should be sent immediately. Vessels should contact the terminal at least 2 hours before arrival. Tugs are required for berthing and unberthing.

Vessels in the vicinity of Pointe-a-Pierre are requested not to use VHF channels 6 and 10, which are used for transshipment operations.

**Contact Information.**—The pilots and Port Control can be contacted, as follows:

1. Call sign: Pointe-a-Pierre Shipping

2. VHF: VHF channels 11, 13, and 16
3. Telephone: 1-868-658-4200
4. Facsimile: 1-868-658-4636

**Anchorage.**—An anchorage, restricted to vessels of 200,000 dwt or more and for ship to ship transfer operations, lies 1.5 miles SSW of the SPM.

Other vessels should anchor at least 1 mile E of the above anchorage. Transshipment anchorages, which may best be seen on the chart, have been established 4 miles W of the head of the viaduct.

**Caution.**—Vessels are prohibited from anchoring within 1 mile of the SPM or within 0.3 mile of the pipelines, as indicated on the chart. In addition, vessels are forbidden to cross any of the submarine pipelines lying off Pointe-a-Pierre.

**1.39 San Fernando** (10°17'N., 61°28'W.) stands on the coast, 2.5 miles S of Pointe-a-Pierre. It can be easily identified by Naparima Hill, which rises close E, and Mon Chagrin, 85m high, which stands 0.4 mile E.

The port is used by small coasters. A pier, 122m long, extends from the shore abreast the town and has a depth of 1.8m alongside. An approach channel leads to the pier and has a least depth of 1.8m. It was reported (1986) that the channel was disused and the buoys removed. It was reported (2008) that the channel has been repositioned.

**Hughes Rock** (10°17'N., 61°30'W.), with a depth of 1.2m, lies 1.8 miles WSW of the head of the pier. Farallon Rock, 4.6m high, lies 0.3 miles SW of the pier. A wooden building and a flagstaff stand on this rock.

A drying reef, with the remains of several piles about 0.6m high on it, lies close off Bontour Point, about 0.5 mile S of the head of the pier.

**Anchorage.**—Anchorage can be taken, in depths of 7 to 13m, between 1.3 miles and 2 miles from the head of the pier with the summit of Naparima Hill bearing 107°.

### San Fernando to Cedros Point

**1.40** The coast between San Fernando and Pitch Point (10°15'N., 61°37'W.), 9 miles WSW, is bordered by Oropuche Bank. This bank has depths of less than 5m and extends up to 3 miles offshore. A conspicuous white shed stands on the shore, about 3 miles SW of San Fernando.

Pitch Shoal, a small patch with a least depth of 7m, lies close off the NE side of Oropuche Bank, 1 mile WSW of Hughes Rock.

**1.41 Brighton** (10°15'N., 61°38'W.) (World Port Index No. 11760) is a natural coastal harbor. It consists of the piers at La Brea, situated E of Pitch Point, and the pier and facilities at Brighton, on the W side of Pitch Point.

**Tides—Currents.**—The tidal currents off the pier at Brighton are strong. The SW current attains a rate of 1.5 to 2.5 knots and the NE current attains a rate of 1 to 1.5 knots. The tidal currents from Dragons Mouth and Serpents Mouth meet just E of Brighton, but they are irregular.

**Depths—Limitations.**—The pier at La Brea extends N from a point located 0.2 mile SE of Pitch Point. It is 0.4 mile long, but reported (1985) to be disused and unsafe. A mooring buoy is situated 0.1 mile NW of the pier head.

Two mooring buoys are situated about 0.5 mile NNE of Pointe d'Or and a submarine pipeline extends about 0.3 mile NNW from the former pier to the 10m contour.

Brighton Pier extends 0.2 mile NNW from the shore abreast of Brighton. The quay, total length 400m, has a ro-ro indent on the W end with a continuous jetty length of 279m to the E. There is a depth of 5.9m alongside.

Brighton Pier is brightly illuminated at night and is usually visible from any part of the Gulf of Paria. It has been reported (2013) the pier is disused and in need of repair.

**Aspect.**—A lighted range, bearing 139°15', is situated at Brighton and indicates the approach channel.

A flagstaff and a hotel, standing on the slope of a hill close SE of the root of Brighton Pier, are conspicuous from seaward. Eight chimneys, with several tanks in their vicinity, stand S of the root of the pier and are conspicuous. A prominent silver-colored tank stands at an elevation of 67m, 0.5 mile SE of the hotel.

**Pilotage.**—Pilotage is compulsory for vessels berthing at La Brea or Brighton. Pilots can be contacted by VHF and boards at position 10°17.0'N 61°40.0'W.

**Anchorage.**—Anchorage can be taken, in depths of 13 to 15m, mud, about 0.8 mile NE of Brighton Pier.

**Caution.**—Anchorage is prohibited in the vicinity of the submarine pipeline as charted.

A spoil ground is located W of and parallel to the approach lane, as best seen on the chart. Works in progress (2010) are best seen on the chart.

Oil drilling operations take place within 2.5 miles NE through N to SW of Brighton Pier. Numerous drilling platforms, obstructions, and submarine pipelines may be encountered in this area.

**1.42** Guapo Bay is a slight indentation in the coast formed between Point Galba (10°15'N., 61°38'W.), located 0.5 mile SW of the root of Brighton Pier, and Point Fortin, 4.5 miles SW. This bay is shallow and its E part is encumbered by a bank, which dries. Pelican Rocks, 1.5m high, lie on the bank, 1 mile SW of Point Galba.

**Point Fortin** (10°11'N., 61°41'W.) (World Port Index No. 11770), an oil-loading and LNG terminal, has a loading pier situated at the seaward end of an illuminated viaduct. This viaduct carries a pipeline and extends 1.8 miles NNW from Point Fortin. There are two arms at its head.

The Atlantic LNG Terminal consists of two T-shaped jetties extending 700m NW from the N point of reclaimed land.

**Tides—Currents.**—The currents off the jetty heads set 250° on the flood and 055° on the ebb. The current turns about the time of HW at Georgetown. The maximum rate is about 0.5 knot at springs.

**Depths—Limitations.**—Oil-loading berths consist of the following:

1. Berth No. 1, on the seaward side of the NE arm, is 213m long and has a depth of 11.6m alongside. It can accommodate vessels of up to 35,000 grt.
2. Berth No. 2, on the seaward side of the SW arm, is 213m long and has a depth of 10.9m alongside. It can accommodate vessels of up to 25,000 grt.
3. Berth No. 3, on the inner arm of the SW side, is 91m long and has a depth of 10.5m alongside. It can accommo-

date vessels of up to 6,000 grt.

4. Berth No. 4, on the W side of the viaduct and about 0.8 mile from its root, is 91m long and has a depth of 4.7m alongside. It can accommodate vessels of up to 3,000 grt.

5. Berth No. 5, an offshore loading terminal for large tankers, is situated about 0.8 mile N of Berth No. 1. Tankers up to 260m in length and 15.5m draft can be handled here but are berthed by day only.

A submarine cable extends between the head of the jetty and the offshore mooring buoys situated about 0.8 mile NNE.

At the Atlantic LNG Terminal, berthing can be taken alongside the center of the T-shaped jetties. The terminal can accommodate vessels with a maximum loa of 330m and has an alongside depth of 11.5m.

**Pilotage.**—Pilotage is compulsory. Pilots can be contacted by VHF and board about 0.5 to 1.0 mile NW of the jetty light.

Tugs are available and required for berthing vessels of more than 30,000 dwt at the outer berths.

There is a port radio station at Point Fortin.

**Contact Information.**—The Oil Terminal and Control Center can be contacted, as follows:

1. Call sign: Trimmer
1. VHF: VHF channels 11 and 16
3. Telephone: 1-868-648-2011 (extension 8102)  
1-868-648-2011 (extension 8103)

The LNG Terminal can be contacted, as follows:

1. Call sign: Atlantic Marine
1. VHF: VHF channel 17
2. Telephone: 1-868-648-2916 (extension 2035)
3. Facsimile: 1-868-648-2905
4. E-mail: [atlanticmarine@atlanticing.com](mailto:atlanticmarine@atlanticing.com)

**Regulations.**—Vessels should send ETA messages 72 hours, 48 hours, and 24 hours in advance. Changes of 1 hour in the ETA should be reported.

**Caution.**—Soldado Marine Oil Fields lie up to 10 miles off the coast between Point Fortin and Icacos Point, the SW end of Trinidad, 14 miles WSW. Within this area there are numerous drilling platforms and associated structures, many of which exhibit lights. Many submarine pipelines connect these structures and converge on a landing place in Irois Bay.

The oil field has been declared a restricted area, within which navigation is prohibited to all vessels except those connected with oil field operations and small craft. Anchoring, trawling, and all seabed operations are prohibited.

The N and W limits of the restricted area are marked by lighted buoys.

A further group of lighted oil platforms and wells exist between 1 mile and 5 miles from the W to NE of Soldado Rock outside the Soldado Restricted Area. A submarine pipeline is laid ENE between this group and Riser Platform No. 1 (10°10'N., 61°51'W.).

**1.43 Irois Bay** (10°10'N., 61°44'W.), which is shallow, is a slight indentation in the coast. It is formed between Point Fortin and Point Rouge (10°09'N., 61°47'W.), 6.8 miles WSW. Challenger Shoal, a detached patch, has a least depth of 5.5m and lies 2 miles N of Point Rouge. Several shoal heads lie S of a line extending from Point Fortin to Challenger Shoal and vessels should not proceed S of this line.

Granville Bay, a slight indentation, lies between Point

Rouge and Cedros Point, 2 miles WSW. This bay is fronted by foul ground which extends up to 1 mile offshore.

**Cedros Bay** (10°07'N., 61°52'W.), a shallow indentation, has depths of less than 5m and lies between Cedros Point and Los Gallos Point, 5.8 miles SW.

Barrel of Beef, a rock with a depth of 1.5m, lies 1 mile WNW of Cedros Point. Loo Reef, with a depth of 1.8m, lies close W of Barrel of Beef and is marked on its N side by a lighted beacon.

A shoal, with a least depth of 4.6m, lies 0.8 mile NW of the above beacon. The remains of a light structure stand close NW.

## The Gulf of Paria—West Side—Punta Penas to Punta Mata Redonda

**1.44 Punta Penas** (10°44'N., 61°51'W.) is the E extremity of the Peninsula de Paria; Punta Garcitas is located 5 miles SSW of it.

**Caution.**—A lighted ODAS buoy is situated about 10 miles NNW of Punta Penas. Vessels should keep at least 200m away from this buoy.

**1.45 Ensenada Cariaquita** (10°40'N., 61°54'W.) is entered between Punta Garcitas and Punta Picua, 0.8 mile SW, and provides good anchorage to small vessels. The shore bank, with depths of 5m or less, extends up to about 0.1 mile WNW of Punta Garcitas. Rocks, with depths of less than 1.8m, are located close N and about 0.2 mile WNW of Punta Picua. The head of the bay is shoal and, at times, a considerable current sets across the entrance to the bay.

The coast between Punta Picua and the entrance to Puerto Macuro, 2 miles SW, is composed of red cliffs in places.

A shoal, with a depth of 10.4m, lies about 0.5 mile ESE of the SW entrance point of Puerto Macuro.

**1.46 Puerto Macuro** (10°39'N., 61°56'W.), formerly Cristobal Colon, is divided into two parts by a point, which has a pier in ruins at its outer end. The E part is known as Ensenada Aricagua while the W part is known as Ensenada Macuro. The town of Macuro stands at the head of Ensenada Macuro.

**Tides—Currents.**—The tidal currents in Puerto Macuro attain rates of 1 to 2 knots. The flood current runs clockwise around the harbor; the ebb current runs counterclockwise. The latter current attains the greater rate and reaches its maximum 2 hours before LW by the shore. In the middle of the bay, slack water occurs 1 hour after the stand of the tide.

**Depths—Limitations.**—A wharf extends 165m ENE from a point on the shore located 0.3 mile NNE of the W entrance to Puerto Macuro. It has been reported that vessels of up to 7.9m draft can berth alongside. Two mooring buoys lie close N of the wharf; one mooring buoy lies close S of the wharf.

**Regulations.**—In Venezuelan territorial waters, the Venezuelan flag must be continuously displayed at the fore. At night, on request, the vessel's name must be signaled by light.

**Anchorage.**—Small vessels can anchor anywhere in the bay, but large vessels should anchor just outside a line joining the entrance points.

Except in cases of shipwreck or "force majeure," vessels are prohibited from anchoring within the territorial waters, except off these ports or places used for commerce.

**1.47** The coast between Puerto Macuro and Punta Carmona, 12 miles W, is indented by several small bays and backed by a mountain range with peaks up to 1,073m high. Large spurs extend S from this mountain range and terminate in points which form deep gorges at the head of some of the bays.

**Puerto de Hierro** (10°38'N., 62°05'W.) (World Port Index No. 12275), a natural coastal harbor, is located 9 miles W of Puerto Macuro and formed by a small bight. The port, under control of the Venezuelan Navy, is primarily an ore-transshipment facility.

**Tides—Currents.**—The tidal currents set W on the flood tide and E on the ebb at rates up to 2.5 knots.

**Depths—Limitations.**—The ore-loading pier extends 400m SSW from the E side of the bight. The E side of the pier has depths of 5.2 to 7.9m over a usable length of 210m. The W side of the pier has depths of 3.3 to 4.6m over a usable length of 182m. Dolphins are situated off the head of the pier and a shoal, with a depth of 4m, lies adjacent to them.

A small pier, with depths of 3m along its E side, extends 76m S from a point located close W of the root of the ore pier.

The bay has been reported to have been dredged to a depth of 12.8m, but the 5m curve lies within the approach to the W side of the pier and depths of up to 8.1m lie in the approach on the E side.

The maximum size of vessel permitted to enter the port is 45,000 dwt.

**Aspect.**—The pier, with its towers and oil storage tanks, is prominent when seen from the S and W. At night, a group of lights above the port may be seen at a distance of 20 miles.

**Pilotage.**—Pilotage is compulsory. Pilots may be obtained from Guiria. Vessels should give 72 hours notice and confirm or amend their ETA 48 hours and 24 hours before arrival. Vessels are berthed by day or night, but normally only at slack water.

**Anchorage.**—Anchorage can be taken, in a depth of 16m, sand, good holding ground, about 1 mile S of the pier head.

**Directions.**—Entry is difficult and berthing only at slack water is recommended. Vessels should enter with as little way on as possible and approach the pier on a heading of 021°.

**Caution.**—It was reported that silting occurs in the harbor.

**Punta Carmona** (10°38'N., 62°09'W.) is located 3 miles W of Puerto de Hierro. From the former point, the coast trends 3.3 miles W to Punta Juan Diego, then 3 miles W and 2.5 miles S to Punta El Rincon, and then 2 miles S to Punta Guiria. The bight in the coast lying NE of Punta Guiria is fronted by a shoal area. This area has depths of less than 11m and extends up to 2.5 miles offshore. A detached shoal, with a least depth of 5.8m, was reported (1940) to lie about 1 mile SE of Punta Guiria.

**1.48 Guiria** (10°34'N., 62°18'W.) (World Port Index No. 12270), a small harbor protected by breakwaters, lies close N of Punta Guiria.

The town stands on a low plain. The port is important as a pilot boarding station for vessels proceeding to the river ports on the S side of the Gulf of Paria.

**Depths—Limitations.**—There are depths of 5 to 6m within the breakwaters, except alongside the berths, where less water may be found. A shoal patch, with a depth of 3.2m, lies in the

center of the harbor.

A quay, 140m long with refrigeration facilities, is situated on the inner side of the S breakwater near its head. Three piers project N from the breakwater, W of the quay. The W pier is used by vessels carrying dangerous cargo.

A quay, 170m long, is situated on the inner side of the N breakwater, 0.5 mile from its head.

Four piers project from the W side of the harbor. The N pier is reserved for naval vessels.

**Aspect.**—The port may be identified by the prominent re-roofed towers of a church. Several radio towers and a white tank stand on the high cliffs, close N of the town.

Recalada Guiria Light, shown from a white tower with orange bands, 12m high, stands 1 mile N of the port.

**Pilotage.**—Pilots for Maturin Bar, the Rio San Juan, Pedernales Bar, and the Orinoco Delta can be obtained at Guiria. Incoming vessels must request pilot service by radio 48 hours, and 24 hours prior to arrival. Pilots can be contacted by VHF and usually board in the vicinity of the lighted buoy moored 2 miles ESE of the town, within 1 hour after arrival. It is not necessary to anchor. If for any reason the pilot is delayed, vessels can anchor in the vicinity of the buoy.

Vessels approaching Guiria should identify themselves to the signal station and not proceed inshore of the pilot boarding station at the above lighted buoy.

The pilots can be contacted, as follows:

1. VHF: VHF channel 12
2. Telephone: 580-294-982-1545
3. Facsimile: 580-294-983-1545

**Anchorage.**—Anchorage can be taken E of the harbor, in depths of 10 to 11m, mud, good holding ground.

**1.49** The coast between Punta Guiria and Punta Guaraguara (10°32'N., 62°19'W.), 2.5 miles SW, is cliffy and tree covered.

Between Punta Guaraguara and Punta Arenas, 23 miles SW, the W part of the Gulf of Paria is almost entirely encumbered by shoals and fringing flats. There are no commercially significant ports within this area.

Three detached shoals, with depths of less than 10m, lie between 6.5 miles and 9 miles SW of Punta Guaraguara. Vessels bound for Barra de Maturin are advised to pass E of these patches. It was reported that lesser depths than charted lie in the vicinity of, and on the above-described patches.

The **Rio San Juan** (10°15'N., 62°36'W.) discharges into the Gulf of Paria between Punta Arenas (10°20'N., 62°38'W.) and Punta Campana, 6.5 miles SSE.

Barra de Maturin (Maturin Bar) lies across the mouth of this river and has a dredged channel with a least depth of 7.9m. It was reported (1995) that vessels with drafts up to 10m were permitted to use this channel.

It was reported (1993) that silting had changed the shape of the charted coastline in the vicinity of Punta Campana. A lighted buoy is moored about 9 miles NE of Punta Campana and marks the entrance to the dredged channel. From this buoy to Punta Gorda, located 4.5 miles SSW of Punta Campana, each reach of the dredged channel is indicated by lighted ranges. A number of beacons are situated in the vicinity of the channel and should not be confused with the range lights.

From a point located 2 miles SSE of Punta Gorda (10°10'N.,

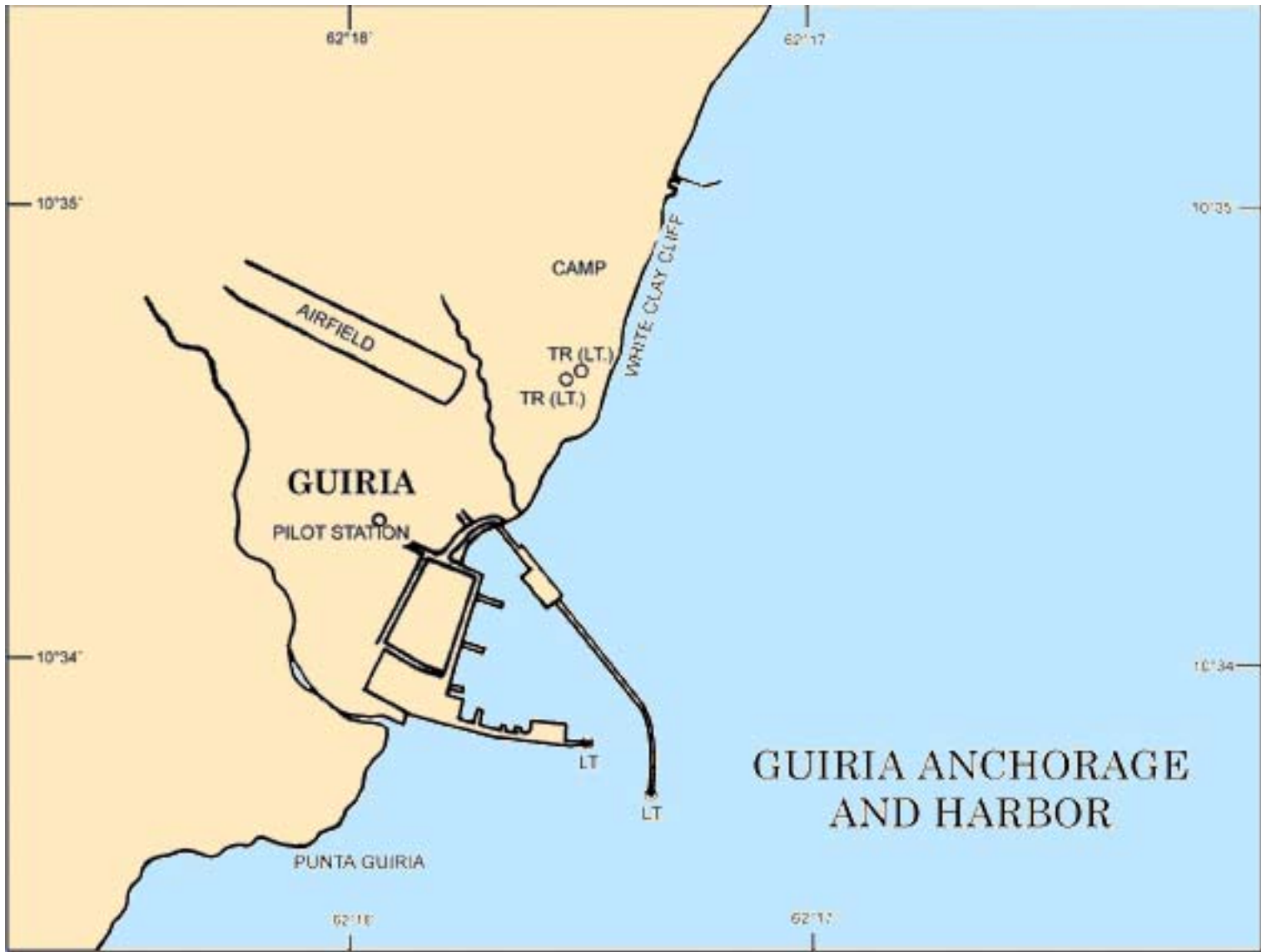



62°38'W.), the channel has depths in excess of 11m as far as Punta Carner, 32 miles upriver.

The Cano Frances joins the Rio San Juan, 20 miles above its mouth. It is about 230m wide and trends SW for almost 13 miles. It is joined here by the shallow and narrow the Rio Guarapiche, which trends W for 3.5 miles to the Cano Colorado. From the junction of the Cano Frances and the Rio Guarapiche, a stream, known as the Cano dos Aguas, trends in a N direction and joins the Rio San Juan 7 miles below Punta Carner. One-way traffic is operated in the Rio San Juan above its junction with the Cano Frances at Punta Marieta. Inbound vessels required to wait may anchor in this area.

The Rio Guanoco empties into the Rio San Juan, close W of Punta Carner. The village of Guanoco stands on the W bank of the Rio Guanoco, 3 miles above the junction.

**Caution.**—Vessels are advised that the currents are strong over the bar and within the river.

**1.50 Guanoco** (10°10'N., 62°56'W.) is situated at the base of two hills, 107m and 76m high. A large deposit of pitch is located here.

**Depths—Limitations.**—A wharf, with a depth of 7.6m alongside, fronts Guanoco. The approach to Guanoco through the Rio Guanoco is only suitable for vessels with local knowledge. The river is about 140m wide and has depths of 3 to 9.1m in the fairway. The controlling depth in the channel is 5.5m.

The river above the mouth of the Rio Cicaro is narrow. Vessels are turned at this junction and towed stern first about 0.8 mile up to the wharf at Guanoco. Vessels should moor their sterns very securely because of the strong currents. Vessels up to 85m in length can negotiate the turns when loaded.

**Pilotage.**—Pilotage in the Rio San Juan is compulsory. Pilots can be obtained at Guiria, but 3 days advance notice is required.

From **Punta Carner** (10°07'N., 62°57'W.), the Rio San Juan trends in a SW direction and then NW to Caripito, which stands 51 miles above the entrance to the river.

**1.51 Caripito** (10°10'N., 63°02'W.) (World Port Index No. 12280) is situated on a tributary of the Rio San Juan, 3 miles W of the river. It is connected to the port area by rail and road.

**Depths—Limitations.**—Vessels entering are restricted to a maximum draft of not more than 10.4m.

Three piers and a wharf front the W bank of the river. The wharf, which is known as Muelle No. 1, is 107m long. It can accommodate vessels of up to 137m long and 7m draft.

Muelle No. 2 and Muelle No. 3 are T-head piers, with dolphins situated close off their faces. They have a depth of 10.7m alongside. Vessels of up to 61,000 dwt, 230m in length, and 10.3m draft can be accommodated at these piers.

Muelle No. 4 is situated upstream of Muelle No. 1. Its T-head is 12.2m long and has a depth of 4.3m alongside.

Tankers of up to 52,000 dwt, 225m in length, and 10m draft can be accommodated within the port. The usual method of berthing is for vessels to proceed up river from the piers and turn around. If necessary, arrangements can be made for vessels to top off seaward of Barra de Maturin.

**Pilotage.**—Pilotage is compulsory. Pilots are embarked and disembarked at the port of Guiria. Vessels awaiting a pilot should proceed to the Guiria Sea Buoy (10°33'N., 62°15'W.)

and display the usual signals.

**Anchorage.**—Vessels unable to berth at Caripito usually anchor about 0.5 mile upriver. However, at times, the current attains a rate of 3.5 knots. Anchorage is also available, in a depth of 14m, about 0.3 mile upstream.

**Caution.**—It was reported (1995) that many beacons were unlit or destroyed completely.

## Mouths of the Rio Orinoco within the Gulf of Paria

**1.52** From Punta Campana to Punta Mata Redonda (10°12'N., 62°31'W.), 5 miles SE, the coast is fringed by a drying mud bank extending up to 0.8 mile seaward. A dangerous wreck, marked by a buoy, is located 9.5 miles E of Punta Mata Redonda. Between Punta Mata Redonda and Punta Tolete, 22 miles SE, the coast is indented by a large shallow bay, which has depths of 5m and less over its entire area. The bay is largely filled with mud flats and is navigable only by the smallest craft. The W of the intricate network of waterways, which intersect the delta of the Orinoco, lies at the S end of the bay. Nearly the entire shore of the bay is covered by a dense growth of trees of uniform height.

Several islands lie within the bay and are separated by rivers. From W to E, these rivers are the Cano Jacao, the Cano Vagre, the Cano Mananito, the Cano Manamo, and the Rio Pedernales.

The Rio Pedernales, the most important of these rivers, is entered between Isla Cotorra and Punta Tolete (10°02'N., 62°12'W.), 1 mile E. It was reported that the bar had a least depth of 3.4m, but silting causes rapid changes. The bottom is soft with good holding ground. Three lighted buoys mark the entrance of the Rio Pedernales. Buoy No. 1 is moored in position 10°04'N, 62°07'W

Within the bar, the Rio Pedernales divides into two channels. The E channel leads to the Cano Pedernales and the W channel to the Cano Manamo. The latter channel is used by coastal vessels.

The tides rise about 1.6m at springs and 1.2m at neaps.

When the river is low, the currents in the vicinity of the bar are weak and set in a NE and SW direction. Within the bar, slack water occurs 1 hour 30 minutes after the stand. The currents usually set in the direction of the channels and attain rates of 2 to 3 knots.

**1.53 Puerto Pedernales** (9°59'N., 62°15'W.) stands on the N end of Isla Pedernales, 4.5 miles SW of Punta Tolete. Entrance between Punta Tolete and the E point of Isla Cotorra 1.5 miles W where it is thickly wooded and swampy. The bar of the river lying 5 miles NE of Punta Tolete has a reported depth of 3.4m but silting causes rapid changes.

Oil installations are situated in the vicinity of Puerto Pedernales. Capure, 0.8 mile NE of Puerto Pedernales, is the site of a T-head pier which is used by small tankers with drafts up to 4m. An older wharf is situated about midway between Capure and Punta Tolete.

**Pilotage.**—Pilotage is compulsory. Pilots embark at Guiria and will take vessels upriver as far as Ciudad Bolivar.

**Anchorage.**—Anchorage is also available, in a depth of 9m, fine gray sand, abeam of a village situated about 1 mile SW of



Puerto Pedernales

Punta Tolete.

### Punta Tolete to Punta Baja

**1.54** The coast that forms the S side of Serpents Mouth extends 80 miles E and SE to Punta Baja and encompasses part of the delta of the Rio Orinoco. This part of the coast has been only partially surveyed. Depths of 18m have been reported to lie 4 to 5 miles off the W section of the coast, decreasing gradually toward the shore. Similar depths are reported to lie up to 13 miles off the E part of this coast.

**Punta Bombeador** (9°55'N., 61°40'W.) is located 34 miles ESE of Punta Tolete and has a bank, with a least depth of 2.7m, extending 3 miles NW from it. A channel leads in a SW direction through this bank to the mouth of the Cano Macareo. The maintenance of this channel has been discontinued and the navigational aids removed. Local knowledge is required. An anchorage area has been established 2.8 miles NE of Punta Bombeador.

The Cano Macareo is entered S of Punta Pescador (9°53'N., 61°39'W.), about 1.5 miles SSE of Punta Bombeador. It connects with the Rio Orinoco and is used by shallow draft vessels. Pilotage is compulsory. The current at the mouth of the river attains a rate of 2 knots from December through April and 3 knots from May through November.

The coast between Punta Bombeador and Punta Baja, 48 miles SE, is intersected by several shallow waterways and fronted foul ground extending up to 6 miles offshore in places.

### The Rio Orinoco Delta

**1.55** From **Punta Baja** (9°31'N., 60°58'W.), the coast of Venezuela extends 64 miles SE to Punta Barima. This latter point is located at the SE end of the delta of the Rio Orinoco.

A light with a racon has been reported (2004) to be situated 0.6 mile SSE of the old light structure on Punta Barima.

The delta has its origin at a point below Barrancas, 120 miles upriver from Punta Barima, and is comprised of several rivers and streams.

Boca Grande, the main entrance to the Rio Orinoco, flows

through the S side of the delta and has two channels which lead through it.

The coast in the vicinity of Boca Grande is difficult to distinguish and it is advisable to take soundings continuously. It has been reported that vessels can go aground to the N of the mouth while still out of sight of land. Approaching Boca Grande from the N, vessels are usually in shallow depths before any landmarks are sighted. In the approach to the bar, the bottom consists of soft gray mud. During heavy weather, a high and dangerous sea breaks over the bar. Care should be taken not to approach within 2.5 miles of Punta Barima, because discolored water makes the steep-to banks invisible. The bar extends up to about 20 miles seaward.

The channel leads over Boca Grande bar into the Rio Grande branch of the Rio Orinoco off Punta Yatica. It then extends 15 miles to the Brazo Imataca reach, which leads S and W for about 47 miles, and rejoins the Rio Grande near the village of Sacupana. The channel then follows the Rio Grande for about 36 miles to the bifurcation of the Rio Macareo, passing N of Isla Tortola. The channel then follows the main fairway of the Rio Orinoco for 53 miles from Barrancas to Matanzas.

**Tides—Currents.**—In the approach to Boca Grande, the South Equatorial Current sets NW at a rate of 1 to 3 knots. Between the discolored river water and the sea water, there is a distinct line which moves with the tides. At HW, the line is in depths of 7 to 9m and in depths of 11 to 14m at LW.

For a short distance offshore, the currents set for about 6 hours each way and allowance must be made for the W current when crossing the bar.

A choppy sea is raised in depths of less than 18m when the prevailing winds are NE.

The seasonal rise of the Rio Orinoco and its tributaries begins immediately after the vernal equinox and reaches its maximum height in July and August. The lowest level is reached in mid-November through mid-April, but at Ciudad Bolivar, the river is low from December to March.

At Barrancas, at the head of the delta, the maximum rise is about 9.1m. Above Barrancas, the normal rise is estimated to be about 15.2m, varying according to the width of the river, the number of tributaries, and the distance from the sea.

The average annual rise at Ciudad Bolivar is 12.8m.

**Depths—Limitations.**—The North Channel, which leads through Boca Grande, is available to shallow draft vessels and small craft. A lighted buoy located 9 miles NW of the dredged channel approach buoy marks the entrance to the N channel. It joins the water of the dredged channel, 6 miles NNW of Punta Barima. It was reported (1990) that this channel no longer exists.

The South Channel is used by deep-draft vessels proceeding to Puerto Ordaz and the iron ore port, located 157 miles upriver from Punta Barima. The South Channel is also used by vessels proceeding to Matanzas, another iron ore port, situated 12 miles farther upstream. The bar channel depth is maintained in accordance with the authorized draft in the upper river and has been reported to vary between 9.9m and 13.7m at LW and HW stages, respectively. The waterway is open to shipping 24 hours a day and, except for the dredged channel section, two-way traffic can be handled. Vessels should contact Puerto Ordaz Port Radio before attempting transit and entry of the port.

The river is maintained and marked from the dredged South

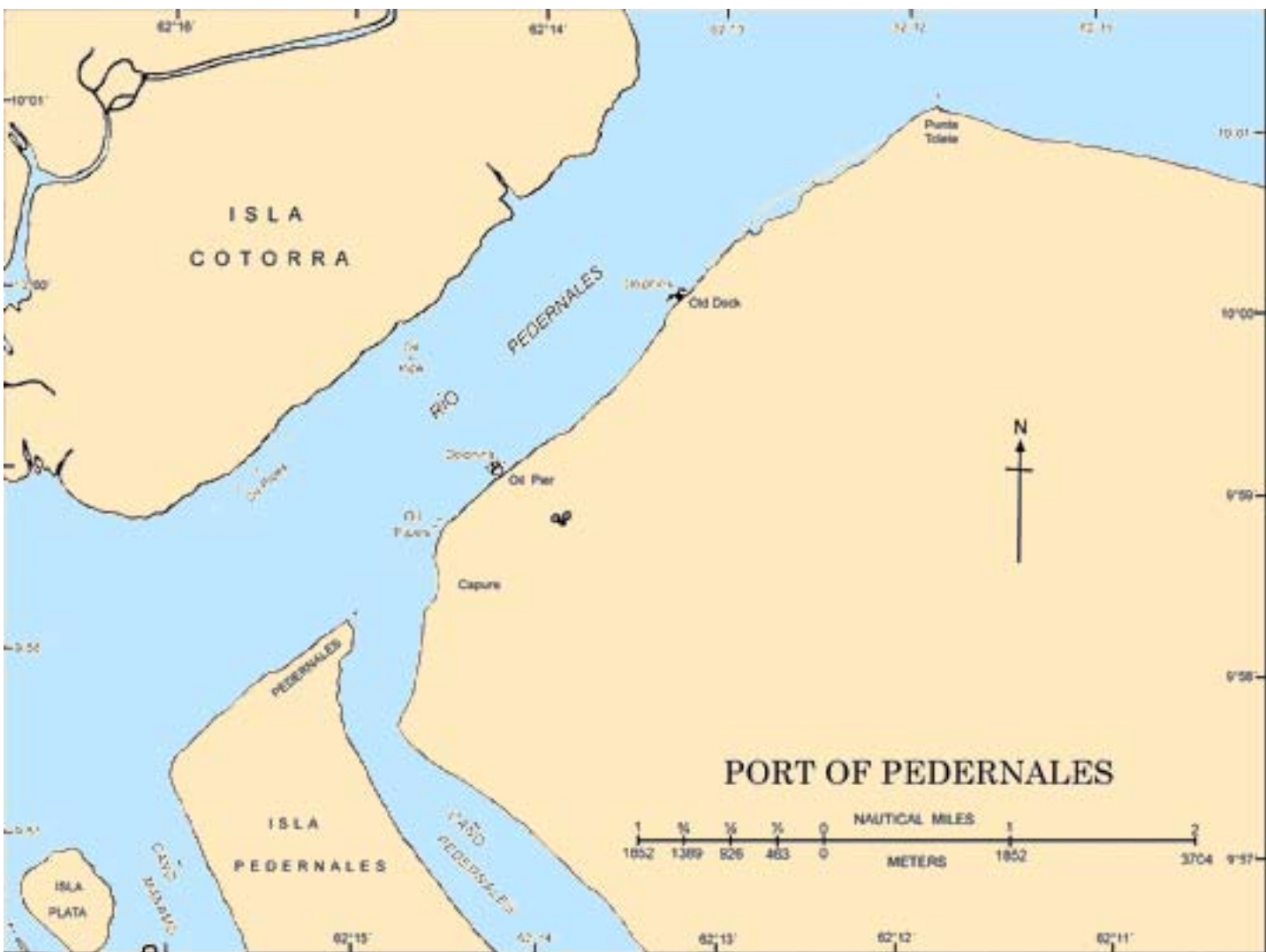

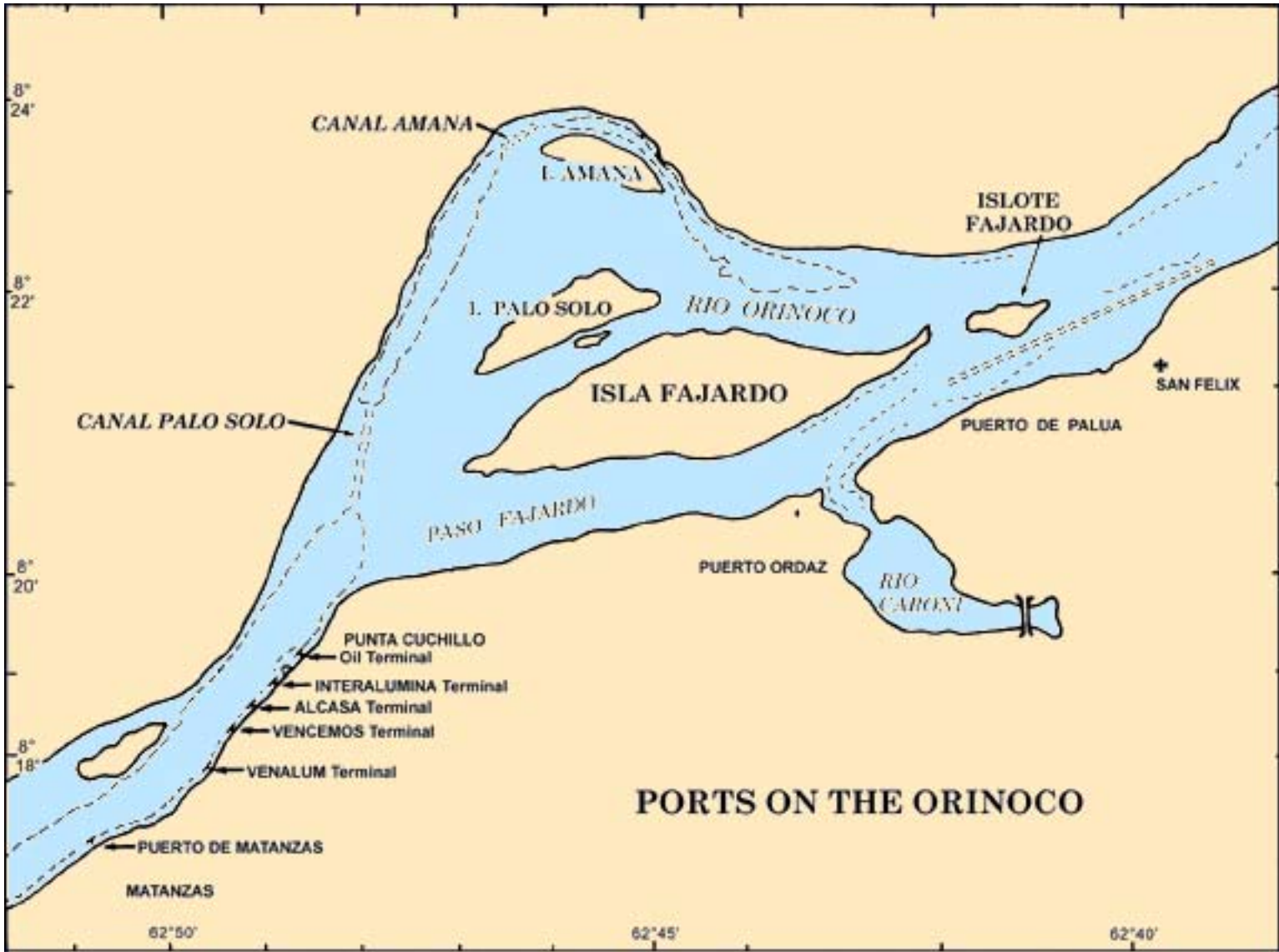

Channel Lighted Buoy to Matanzas for vessels with drafts of up to 12.8m (1987), under optimum river level and tide conditions. Under extreme low river conditions, the authorized draft should not be more than 9m. The months of the lowest water level in the river are March and April. The highest water level occurs from July to October.

The daily authorized draft is promulgated by the Port Captain of the Rio Orinoco, by means of a bulletin in Spanish and English. The maximum authorized draft is subject to the vessel's maximum fresh water load line.

Vessels with drafts up to 2.3m can, at all times, reach Ciudad Bolivar. From May to January inclusive, vessels with drafts up to 4.6m have no difficulty ascending to this city, but the best months are said to be from June to October.

**Pilotage.**—During the passage over the bar and within the river, vessels must maintain a continuous radio watch. Radio stations are situated at the pilot station, Punta Barima, and Puerto Ordaz. These stations provide voice communications along the entire route. The River Officer at Puerto Ordaz, by reference to the mile numbers of the navigational aids, provides continuous radio information of the latest positions of vessels in the dredged channels and the river. Vessels must report their positions in the river hourly to Puerto Ordaz, from where all traffic is controlled.

Vessels should not enter the dredged channel until permission is received from the pilot station or Radio Marina Puerto Ordaz. Vessels without permission are required to remain at anchorage 1 mile W of the approach buoys for either N or S channel. Once permission is granted vessels should send their ETA at Lighted Buoy No. 28 to the pilot station. Once in the New Barima channel, position reports are due every hour.

Pilotage is compulsory for transiting the Rio Orinoco. Subject to a vessel's ETA being reported by radio, the pilot will board in the vicinity of Lighted Buoy No. 28, about 5 miles W of Punta Barima. The ETA should be sent as soon as possible and again 24 hours in advance of arrival at Punta Barima. Actual arrival at the Approach Buoy should be reported to the pilot stations by voice radio and the position of the vessel reported hourly until the pilot is embarked.

Pilots board and disembark vessels in the vicinity of Mile 36, due to sea conditions at the sea buoy which prevent boarding from small boats. Once the pilot boards vessels should send the name and time of boarding to the pilot station.

The pilot stations at Palua and Ciudad Bolivar are in radio communication with the stations at Punta Barima and Puerto Ordaz.

The pilot usually remains on board the vessel for the return trip, unless the duration of stay is expected to be lengthy.

**Regulations.**—Outbound vessels have the right of way.

Vessels entering the river must carry only clean ballast.

Vessels must display the Venezuelan flag at all times from the time of entry into the approach channel leading into the Rio Orinoco.

No vessel is allowed to anchor in the narrow channels of the river or close to a turn.

All vessels needing to anchor in the area between Punta Barima and Mile 137, at the junction of the Cano Macareo, can do so; however, vessels must anchor as close as possible to the right hand bank.

Emergency anchorage must be taken in such a way as to

avoid obstructing the channel.

River regulations provide for anchoring, as follows:

Mile marker	Depth
139.3 to 140.4	12.8 to 20.0m
150.1 to 151.7	22.0 to 27.4m
178.0 to 179.0	23.8m

During HW stage, usually from May 15 to November 15, anchorage can be taken at the junction of the Rio Orinoco and the Rio Caroni, within 1 mile of the ore loading berth.

Prior to entering the dredged channel from seaward, vessels must contact Puerto Ordaz port radio station and report their name, nationality, and ETA off the pilot station at Punta Barima. Vessels will then be given instructions either to enter, anchor, or wait for an outbound vessel to clear the channel. In the waterway, the outbound vessel is privileged.

**Signals.**—Vessels should exercise extreme care when meeting or passing dredges. Dredges working in the dredged channel through the bar in the approach to the Rio Orinoco use the International Code of Signals. Those working in the Rio Orinoco use the signals described below:

1. Vessels approaching a dredge should sound one long and three short blasts.
2. If the dredge then sounds one short blast, the vessel is to direct course to starboard and keep the dredge on the port bow.
3. If the dredge then sounds two short blasts, the vessel is to direct course to port and keep the dredge on the starboard bow.
4. If the dredge then sounds two long and two short blasts, the vessel must not pass the dredge.
5. The dredge signal must be answered by the vessel.
6. If two vessels are approaching the dredge from opposite directions, the dredge will answer the outbound vessel first.

The operating frequencies for YVM Marine Radio in Puerto Ordaz are 468 kHz, 4192 kHz, 6265 kHz, 6320 kHz, and 8386 kHz.

The GMT-CQ and frequencies are:

- a. 472kHz
- b. 4322 kHz—0300, 0900
- c. 6372.5 kHz
- d. 5 kHz—1200
- e. 8453 kHz—0030, 1430, 2000

Upon contact with YVM Marine Radio Station, vessels will receive all navigational information for transit of the Rio Orinoco, and also channel clearance upon request to Port Captain at Ciudad Bolivar.

Vessels may also contact the port on VHF channels 6, 13, 14, and 16.

**Anchorage.**—Anchorage can be taken, in a depth of 26m, at Matanzas, about 0.8 mile NE of the head of the pier.

The river is narrow at Ciudad Bolivar and there are depths of 27 to 55m at low river stage. Anchorage can be taken with a single anchor, in a depth of 12.8m, about 0.2 mile E of the market place and 0.2 mile offshore. This berth is out of the main river current and vessels will not swing more than 45°. The

currents attain a rate of 5 knots between August and December.

Good temporary anchorage can be taken in the vicinity of the lighted approach buoy, clear of the entrance. This buoy, equipped with a racon, is the landfall for the dredged channel. Secure anchorage can be taken off Punta Barima with the disused lighthouse bearing 100° and distant 4 miles.

**Caution.**—It was reported (1993) that some of the lighted ranges were inadequate. Night transit is not recommended.

It was reported (1986) that strandings in the Rio Orinoco had increased significantly. The river is navigable by large vessels up to about 200 miles above the sea buoy. Over most of this distance, vessels must negotiate a narrow channel, said to be only 99m wide between buoys, which is subject to strong cross currents. The variation in the channel depths is considerable, varying according to season in the upper river above Mile 44, and tidal below.

A feature of the Rio Orinoco is that the bottom consists of a layer of very soft mud, virtually in suspension and partly mobile, which is known locally as the "calambrina." The consistency of this mud is such that it shows on most echo sounders, but the depth shown depends partly on the frequency of transmission. The "calambrina" is more pronounced in the summer months, when rainfall in the interior is high, bringing down sediment in the river. The existence of the "calambrina" and its mobility makes it difficult to calculate the actual depth of water in the channel.

hinder their passage across the bar. Vessels with drafts of more than 7.5m are likely to have to force a passage through a layer of mud, 1m or more thick, with a consequent loss of speed up to 50 per cent.

The Instituto Nacional de Canalizaciones (INC) publishes daily bulletins that give the controlling depths, authorized drafts, etc., for the river.

All navigational aids are numbered on the chart with their distance in miles from the seaward entrance to the dredged channel through Boca Grande.

The dredged channel is 30 miles long and 122m wide. The channel is marked by lighted beacons and lighted buoys; however, it was reported that many of these aids differ from those charted. Up-to-date information will be given by the radio station at Puerto Ordaz. Many of the lighted ranges were reported (1986) to be defective and the channel is not recommended for deep-draft vessels at night.

**River distances.**—The river distances are given in the table titled **Rio Orinoco—River Distances**.

### The Rio Orinoco—Port Terminal Facilities

**1.56** Only the more important port facilities of the Rio Orinoco are included. They are described in ascending order from the seaward to the head of the navigable waterway. Unless otherwise indicated, the distances shown are from Punta Barima.

**San Felix** (8°22'N., 62°40'W.), a general cargo port, fronts the S bank of the river, 153 miles upstream. A floating pier extends from the shore abreast the settlement. Its outer face is 123m long and can accommodate vessels of up to 8.8m draft at low river.

**1.57 Palua** (8°22'N., 62°41'W.) (World Port Index No. 12330) stands on the E side of the junction of the Rio Caroni and the Rio Orinoco, 155 miles above Punta Barima.

Berthing alongside the iron ore terminal presents no difficulty, except when the river currents are strong. The use of a tug is advisable at such times. Tugs are generally used for docking and undocking, with a third tug used for vessels with drafts in excess of 10.9m when undocking. Four tugs are available at the port. Docking is always done port side-to.

The berthing facilities at the ore loading terminal consist of a pier, about 0.2 mile long, which is aligned upstream and downstream in the general direction of the current. Vessels with maximum drafts ranging from 9.7m to 13.1m can be handled, depending upon the river stage. Vessels of up to 100,000 grt, 274m in length, and 34m beam can be accommodated, provided that ballast can be moved to allow proper loading.

**1.58 Puerto Ordaz** (8°21'N., 62°43'W.) (World Port Index No. 12335), an important ore-loading terminal, stands at the junction of the Rio Caroni and the Rio Orinoco, 157 miles upstream from Punta Barima. A dam extends into the Rio Caroni just above the terminal.

**Depths—Limitations.**—The port facilities are approached through a buoyed channel and a turning basin, which are maintained by dredging to a depth sufficient to accommodate vessels of up to 10m draft. The width of the turning basin varies between 488m and 610m. The ore-loading wharf, which pro-

Rio Orinoco—River Distances		
Positions	Distance between positions	Total distance from Punta Barima
Boca Grande Waterway Entrance (sea buoy) to Punta Barima	27	27
Punta Barima to Punta Yatica	15	15
Punta Yatica to Curiapo	18	33
Curiapo to Sacupana	48	81
Sacupana to Barrancas	35	116
Barrancas to Los Castillos	18	134
Los Castillos to San Felix	19	153
San Felix to Pulua	2	155
Palua to Puerto Ordaz	2	157
San Felix to Matanzas	16	169
Matanzas to Ciudad Bolivar	43	212
Ciudad Bolivar to Muiaco	62	274
Muiaco to Quanare	17	291
Quanare to Boca del Inferno	12	303
Boca del Inferno to Mapire	16	319
Mapire to Puerto Ayacucho	310	629

Vessels are warned that the "calambrina" may severely

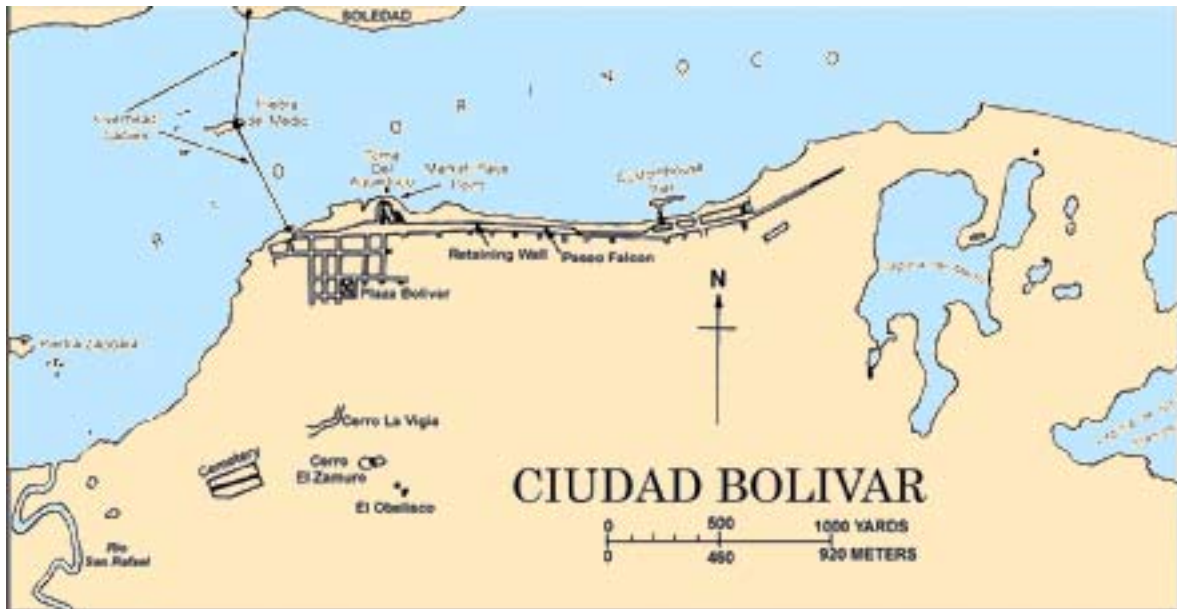

### Ciudad Bolívar

vides three berths, is 575m long and has a depth of 12.1m alongside.

Between Mile 165 and Mile 167 there are five private terminals.

Punta Cuchillo Oil Terminal consists of a T-headed platform, 20m long, with two mooring dolphins. It can accommodate vessels of up to 47,000 dwt. The platform has a depth of 12.2m alongside at low river, when the current is negligible. At high river, the current in mid-channel attains a rate up to 6 knots. The loading depth is controlled by the stage of the river in the channel.

Interalumina Terminal has a concrete pier, 350m long. It can accommodate vessels of up to 60,000 dwt, with drafts of between 9.8m and 12.8m. To berth, it is recommended that the turning basin at Matanzas be used.

Alcasa Terminal has a loading pier, 45m long, with several off-lying buoys. It can accommodate vessels of up to 45,000 dwt, with drafts of between 8.8m and 12.5m, depending on the stage of the river.

Vencemos Terminal is situated on the E side of the river, about 0.4 mile SW of Alcasa Terminal.

Venalum Terminal is situated on the S bank of the river and handles alumina and aluminum ingots. The terminal consists of a quay, 215m long, with a depth of 12m alongside at LW.

**Caution.**—Berthing is difficult at the facilities because of the strong currents, therefore, a docking pilot and tug are used. Several barges are available should it be necessary to lighten vessels in the case of grounding.

The channel buoys are moved as necessary to provide the largest navigable area, depending on the water level in the river.

**1.59 Puerto Mantanzas** (8°17'N., 62°51'W.), an ore-load-



**Ciudad Bolívar (cathedral in foreground)**

ing terminal, is situated on the S bank of the river, about 10 miles above Puerto Ordaz. A concrete pier, about 0.7 mile long, provides eight berths.

Vessels of up to about 30,000 dwt and 132m long can be handled, with drafts up to 7.9m at LW and 9.1m at HW. It was reported (1986) that vessels with drafts up to 12.5m can be handled during the rainy season and with drafts up to 8.5m during the dry season. Berthing can be carried out by day or at night, although the use of a tug is required.

**Anchorage.**—Vessels awaiting a berth may anchor N of Punta Cuchillo or in mid-channel close above the berth.

**1.60 Ciudad Bolívar** (8°08'N., 63°33'W.) (World Port Index No. 12340), a port and the capital of the State of Bolívar, is

the head of ocean navigation on the Rio Orinoco. It stands about 212 miles from Punta Barima. This city is the most notable of those on the Rio Orinoco and a very conspicuous cathedral is situated in it.

**Depths—Limitations.**—The berthing facilities consist of a wharf extending along the shore, fronted by two floating stages. These stages provide two berths. The larger of the two has a depth of 4.6m alongside at low river and 9.1m at high river. It can handle vessels of up to 91m in length. Vessels may not sit

on the bottom in the vicinity of the berths because the river bed is both uneven and steep. Vessels should approach the berths stemming the current. Vessels can also berth close off the river bank and work cargo over temporary gangways rigged to the shore.

**Anchorage.**—A depth of 33m lies close offshore at mean river level. Vessels usually obtain anchorage near the E section of the city. This anchorage area is restricted as the middle of the river is deep.



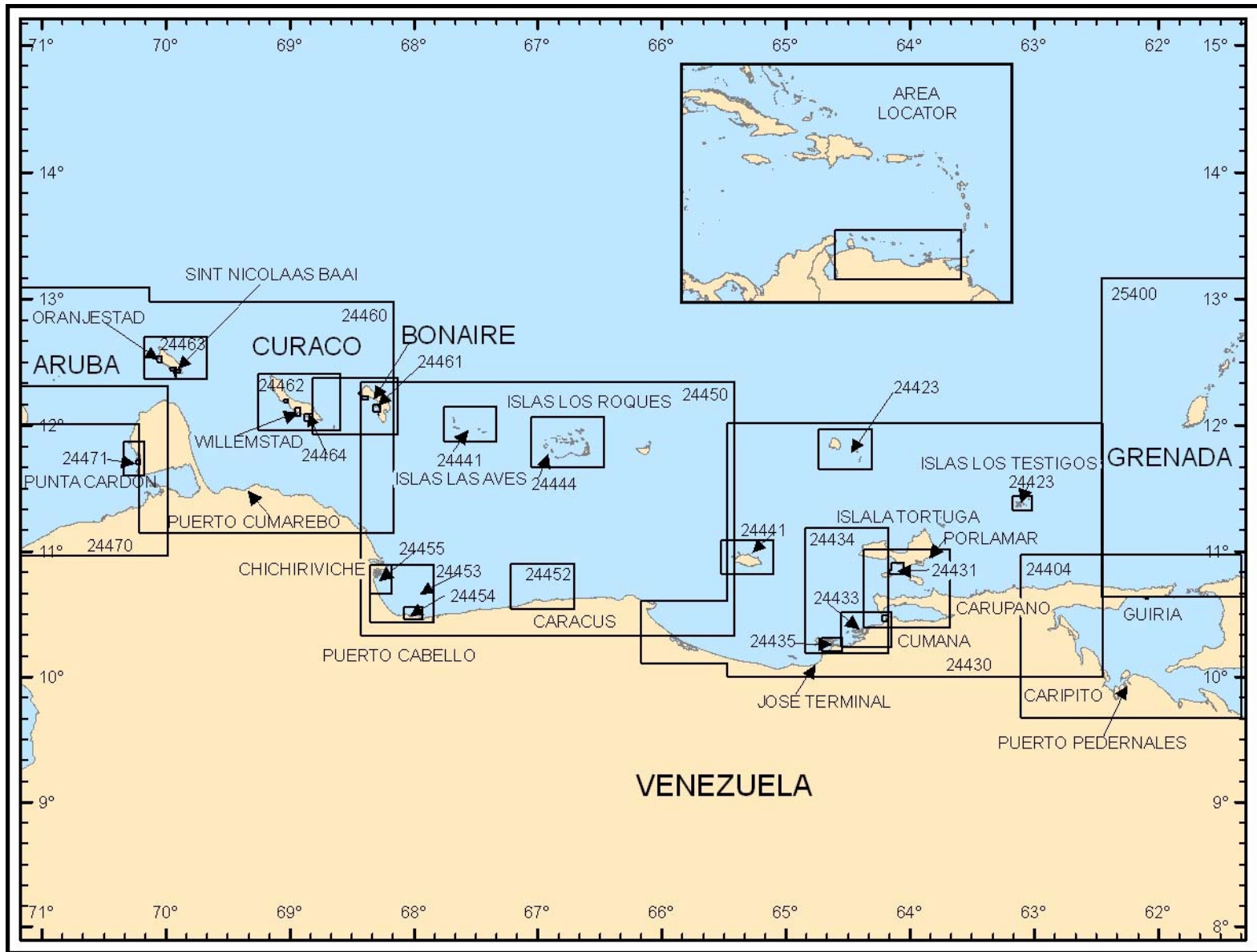

Additional chart coverage may be found in NGA/DLIS Catalog of Maps, Charts, and Related Products (Unlimited Distribution).

**SECTOR 2 — CHART INFORMATION**

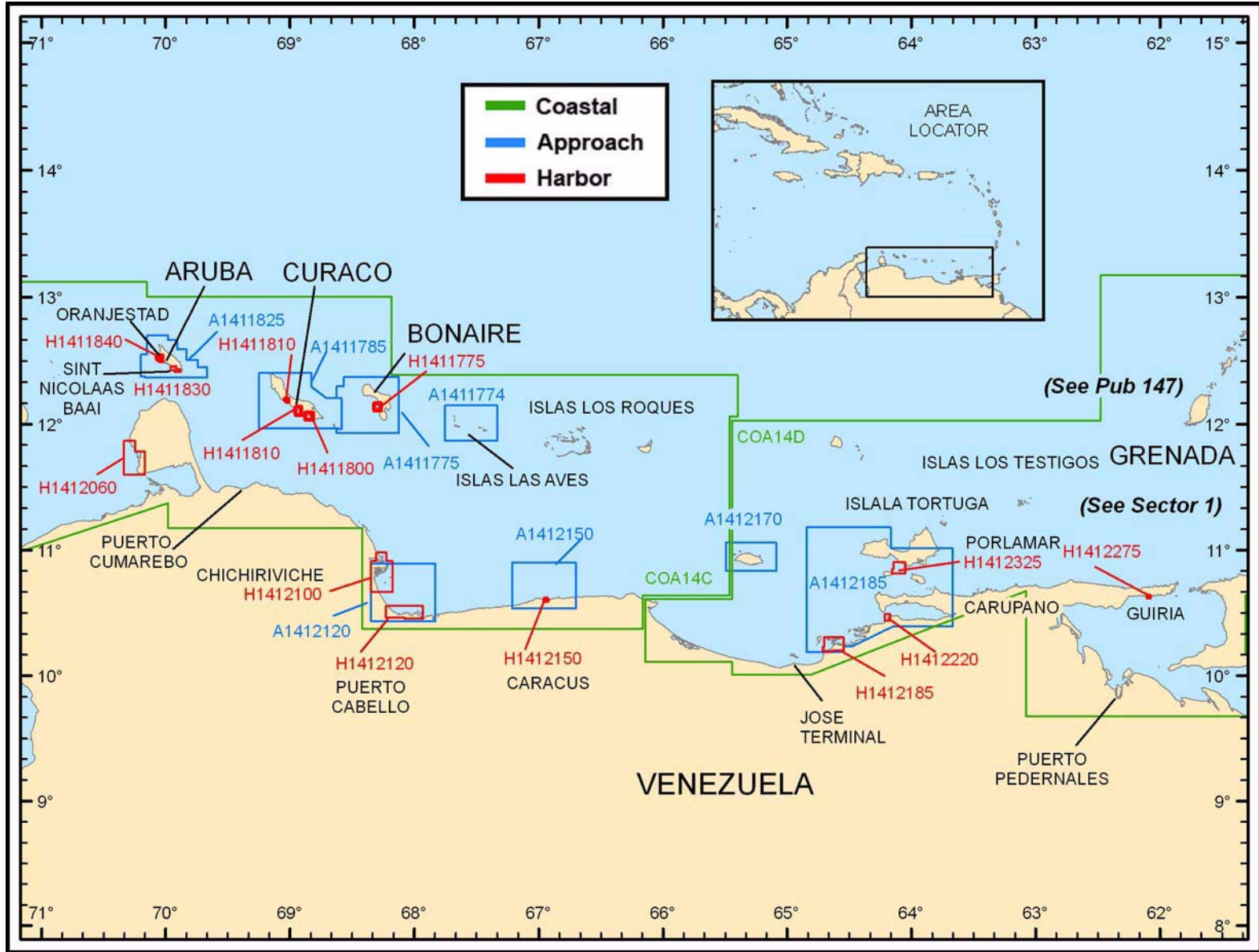

Additional DNC library coverage may be found in NGA DNC 14 (Limited Distribution) disc within the README\GRAPHICS folder.

**SECTOR 2 — DNC LIBRARY INFORMATION**

## SECTOR 2

### ARUBA, BONAIRE, CURACAO, AND THE COAST OF VENEZUELA—PUNTA PENAS TO CABO SAN ROMAN, WITH OFF-LYING ISLANDS AND DANGERS

**Plan.**—This sector describes the N coast of Venezuela from Punta Penas to Cabo San Roman and includes the off-lying islands and dangers. The off-lying islands and dangers are described first and are then followed by a description of the Venezuelan coast. The descriptive sequence is from E to W.

#### General Remarks

**2.1** Vessels navigating along this coast between Punta Penas and Cabo Codera should experience no difficulty. Vessels can pass N of the off-lying islands and dangers, proceeding through Canal Margarita, a fairly deep coastal channel that leads between Isla de Margarita, to the N, and Isla Coche and Isla Cubagua, to the S. This passage is marked by lighted aids for night transit.

Although there are no navigational lights on some of the off-lying dangers, most of these islets and rocks are of sufficient height to give reasonable radar returns. Care should be taken to clear the vicinity of Cumberland Bank, which has shoal heads, and the vicinity of La Sola and Roca del Norte, rocks which are low, steep-to, and detached. Mariners should bear in mind that the general set of the current is to the W.

Puerto La Cruz, with deep-draft oil terminal facilities, is one of the major oil ports of Venezuela. Guanta is one of the more important cargo ports. Puerto Carupano and Puerto Sucre, the port terminal for Cumano, are two smaller ports situated along this section of coast. Oil and cement terminals can be found within Bahia de Pertigalete.

Vessels navigating between Cabo Codera and Cabo San Roman experienced no difficulty in clearing the off-lying islands. Most of the islands are steep-to, prominent, marked by lights, and make excellent radar targets. Care should be taken to navigate with caution when in the vicinity of Los Roques and Islas de Aves, because of the dangerous reefs and low cays in their vicinity.

The coast between Cabo Codera and Golfo Triste is backed by a high mountainous range and is generally bold. The near shore dangers, except for Farallon Centinela, lie within 2 miles of the coast. Between Golfo Triste and Cabo San Roman, the hills and terrain are lower and quite dispersed, with low land being found in places. Between Punta Tucacas and Punta Zamora there are detached dangers on the coastal bank which extends up to 5 miles offshore in places. The more important ports to be found along this section of coast are LaGuaira and Puerto Cabello. The islands of Aruba and Curacao are important oil refining centers.

**Winds—Weather.**—The trade winds in the area are almost constant throughout the year. Moving in a clockwise direction around the Arquipelago dos Acores, they produce throughout the year a predominant wind regime that varies between NE and SE, depending on location and season. The tendency is for predominantly NE winds in autumn and winter, and more E winds in the spring and summer months. There is generally an

increase in the force of these winds from mid-summer through the winter, and a falling off in velocity in spring and early summer. Wind speeds average 8 to 12 knots in most localities. The strongest breeze of the day usually occurs around 1400, with a speed two to three times that occurring during the predawn hours.

Land and sea breezes have a noticeable bearing on the winds over the island areas, adding force to the E winds of the trades on the windward shores, and decreasing velocities to leeward. Such effects are more important over the larger islands where temperature contrasts between land and water are stronger. In such localities these winds are generally directed offshore in the morning at all locations regardless of average weather situations, while later in the day these offshore winds are obscured or reversed by the stronger onshore velocities of the trades. The morning land breezes are generally unnoticed more than 6 miles at sea. Beyond this limit the trade winds again become the dominant control factor. With the passage of an occasional tropical cyclone, the strong circulatory winds take precedence over any local influences.

Squalls accompanied by thunder and lightning are common throughout the area, but are most frequent in the vicinity of land. These storms usually occur during the summer months and are usually preceded by sultry weather and light variable winds.

Temperatures are of secondary importance over this region. Air temperatures over coastal areas average about 23.9° to 26.7°C in the winter months and from 26.7° to 29.4°C in the summer.

The dry season prevails from January through April or May and the rainy season covers the rest of the year. Summer is the wettest season and is usually accompanied by frequent heavy showers interspersed with periods of fair weather and sunshine. In general rain occurs at night or during the early morning hours at sea and in the afternoon over the land areas.

During the summer, thunderstorms are numerous with the frequency varying from place to place. The number is greatest over the larger islands and particularly in mountainous sections. Thunderstorm activity is less frequent during the dry season, because of the lower vertical cloud development.

Visibility is generally good throughout this area, often exceeding 30 miles.

Hurricanes are very seldom a threat to the islands and coastal area described in this sector. They generally pass N of these waters and only occasional heavy rain and seas are experienced.

**Tides—Currents.**—The currents in the offing between Punta Penas and Cabo San Roman generally set W to WNW and attain rates of 1 to 1.5 knots. Occasionally, rates up to 2 knots may be experienced depending upon influences of the wind. There appears to be very little seasonal variation, although tropical storms cause some periodic variation in both set and rate. Rates of less than 1 knot can normally be expected S of

the bank joining Isla de Margarita and Isla de Tortuga. Close to the coast between Puerto La Cruz and Cabo Codera, slight countercurrents have been experienced, but these are normally weak and apparently influenced by the wind and hydrography.

From September through December, in the vicinity of La Guaira, this countercurrent may reach speeds of 2.5 knots at times.

## Off-lying Islands and Dangers

**2.2 Los Testigos** (11°23'N., 63°07'W.), a group of several islets and above-water rocks, lie near the Panama Canal-to-Trinidad shipping lanes. The group has no commercial importance except for fishermen and goat herders who inhabit some of the larger islands. Isla Testigo Grande, the largest island, rises to a prominent hill, 246m high, in its NW part. A light is shown from the summit of this island. The channels leading between some of these islands are deep and clear.

The current in the vicinity of Los Testigos often attains a considerable rate setting between W and NW. In August, its rate may be as much as 1.5 knots; in February, it has been found to set NNW at a rate of 2 knots; and in July, it may attain a rate of up to 3 knots.

Anchorage can be taken, in depths of 25 to 29m, mud, with the summit of Isla Testigo Grande bearing 072° and the W extremity of Isla Iguana (11°22'N., 63°08'W.) bearing 182°. The above-water rocks fronting the NW point of Isla Testigo Grande must be avoided when approaching this anchorage from the NW.

Approaching from the SE, care should be taken in the passage lying between Isla Testigo Grande and Isla Iguana. Pass midway between the islet close E of Isla Iguana and a small islet off the outer end of a reef, which extends 0.3 mile from the SW side of Isla Testigo Grande. The fairway of this passage has a least depth of 11.3m in mid-channel. Isla Testigo Grande has been reported to be a good radar target up to 22 miles and identifiable, with charted features, by radar at 18 miles. Additional lights are displayed on Isla Testigos Grande and Isla Iguana.

**Caution.**—The N islands of Los Testigos are surrounded by relatively deep water. They should be given a wide berth at night due to the constant W current.

Many banks and shoals, with depths of less than 20m, lie up to 19 miles S of Isla Testigo Grande. Depths less than charted may exist; therefore, vessels with drafts exceeding 5.5m should avoid this area.

**2.3 Cumberland Bank** (11°12'N., 63°08'W.), which consists of Daring Shoal on its N part and Green Bank off its E side, lies 3 to 14 miles S and SSE of Los Testigos. Depths of 7.3 to 11m lie over these dangers. The bank is unmarked by any aids to navigation.

**Los Frailes** (11°12'N., 63°44'W.), a group of rocky islets, lie 7 to 9 miles ENE of Cabo de La Isla, the N extremity of Isla de Margarita. These islets have sparse scrub vegetation and are steep-to. The S islet of the group is the largest and rises to an elevation of 91m. Los Frailes has been reported to be radar conspicuous. A light is displayed from the islets.

Anchorage can be taken, in depths of 9 to 14.6m, about 0.2 mile off the SW side of this islet.

**Roca del Norte** (North Rock) (11°16'N., 63°45'W.) lies 3 miles N of Los Frailes. It is small, detached, steep-to, and 3m high. A mooring buoy has been positioned about 25 miles NNE of Roca del Norte.

Isla La Sola, a detached, steep-to rock, 8m high, lies 10.8 miles ENE of Roca del Norte.

**2.4 La Blanquilla** (11°52'N., 64°36'W.), an island, 18m high, appears flat from seaward. The fringing dangers lie within 0.2 mile of the W and S sides of the island and 0.5 mile of the N and E sides. Clumps of trees and rocky outcrops stand on the island. A light is shown from the middle of the S shore.

The best anchorage is off a sandy beach on the W coast of the island, 1.3 miles NE of Punta de La Aguada (11°51'N., 64°39'W.). Vessels anchor, in a depth of 14m, about 0.4 mile off the beach, with a house standing among coconut palms 0.5 mile inland bearing 090°.

A red-roofed house stands at the head of a cove, midway along the S coast of the island.

Anchorage can be taken, in a depth of 26m, about 0.4 mile S of the house. La Blanquilla has been reported to be radar prominent and shows up better when approaching from the W.

**Islas Los Hermanos** (11°47'N., 64°25'W.), a chain of seven barren and rocky islets, lie within 7 miles E and 12 miles SE of the E side of La Blanquilla. They consist of Isla La Orquilla (11°50'N., 64°26'W.), Isla Los Morochos, Isla Grueso, Isla Pico (Isla Pando), Isla Fondeadero, and Isla Chiquito. All of the islets are fairly steep-to and have clear, deep passages lying between them.

A shoal patch, with a depth of 14.6m, lies 0.9 mile E of the SE extremity of Isla Grueso. This latter islet is the largest, attaining a height of 198m. Isla Chiquito, the S and lowest, is the smallest islet. Isla Grueso has been reported to be radar prominent.

**Isla La Tortuga** (10°56'N., 65°18'W.) is barren and rises to a height of over 40m. Punta Oriental, the E extremity, and Punta Arenas, the W extremity, are both low, but distinct. The former point may safely be passed at a distance of 0.3 mile. The S side of the island is bold and steep-to, but its W and NW sides are fringed by a sand and coral shoal that extends up to 2 miles offshore. Another detached shoal area, with a depth of 18.3m, lies 3 miles WNW of Punta Arenas. Las Tortuguillas, two small islets, and Cayo Herradura, a small cay, lie near the outer edge of this shoal. Several radio towers stand in various locations on the island. La Tortuga has been reported to be radar conspicuous. Lights are displayed from Punta Orientale and Cayo Herradura.

Anchorage can be taken, in a depth of 14.6m, sand, about 0.5 miles NW of Punta Arenas, with that point bearing 140° and the center of the W islet of Las Tortuguillas bearing 007°.

**2.5 Farallon Centinela** (10°49'N., 66°05'W.), a prominent light-colored rock, marked by a light with racon, rises to an elevation of 28m. Its NE side is steep, but its SW side slopes gradually to the sea. A rock, which breaks, lies 0.3 mile NW of Farallon Centinela. Farallon Centinela has been reported to be a poor radar target.

**La Orquilla** (11°48'N., 66°08'W.) is generally low and flat, but has seven distinct hills on its N side intersected by low valleys. These hills are visible from a distance of 15 miles, and



**Farallon Centinela Light**

when first sighted from the N or S, appear as separate islands. A hill, 80m high, stands on the W end of the island and Cerro Walker, the summit of the island, rises to a height of 139m about 1 mile E of this hill. Two fairly high hills stand near the NE extremity of the island. A low plain, with mud flats, lies S of the hills. Four lights are shown from the island, as best seen on the chart.

**Caution.**—Due to an established naval base, the area around La Orchilla is restricted and closed to general navigation.

**2.6 Cayo Nordeste** (11°52'N., 66°06'W.) is the largest of several cays lying on a bank extending NNE from the NE end of La Orchilla. Some ruined buildings can be seen on the N end of Cayo Nordeste. A shoal patch, with a depth of 17m, lies on the bank, 5 miles NNE of the N extremity of Cayo Nordeste.

**Puerto Orchilla** (11°51'N., 66°06'W.) lies between the N part of Cayo Nordeste and the cays to the W. La Orchilla has been reported to be radar prominent.

**Banco Burgano** (11°50'N., 65°55'W.), a small detached bank with a reported least depth of 23m, lies 10 miles E of La Orchilla.

## Islas Los Roques

**2.7 Islas Los Roques** (11°50'N., 66°43'W.), a group of many cays on an extensive and dangerous coral reef, lies 22 miles W of La Orchilla. The cays are all low and do not exceed heights of 7m, except El Roque, on the N extremity of the reef. This latter cay rises to a height of 116m at its W end. Scrub covers the cays, and is taller in the E and S parts of the group. Lights are shown from El Roque, about 1 mile ESE of its W extremity; from the SE point of Cayo Grande, the SE island of the group; and from the W extremity (11°50'N., 66°57'W.) of the W cay of the group.

Off Islas Los Roques, the current is generally WNW, with an average rate of 1 to 1.5 knots. Close inshore the currents are variable both in direction and rate, especially off the S and W sides of the group. An E countercurrent has been observed N of the group.

The N extremity of El Roque (11°58'N., 66°41'W.), bearing

077° or more, clears most dangers off the N side of Islas Los Roques. This bearing does not clear a 14m shoal lying in vicinity of (11°55'N., 66°56'W.), which is the northwestern most danger off Islas Los Roques.

A detached shoal patch, with a depth of 10m, has been reported to lie 5.8 miles N of El Roque Light. Vessels passing E of Islas Los Roques should stay in depths of not less than 90m. As it is a lee shore, it is not advisable to approach the reef closer than 2 miles. The S side of the group is steep-to, the 200m curve lying 0.3 to 0.8 mile offshore. Vessels passing along the SW side of the group should also stay in depths of not less than 200m, because of the close proximity of this depth to the fringing dangers.



**El Roque Light**

**2.8 Puerto El Roque** (11°57'N., 66°39'W.), an area lying near the N part of Los Roques and formed by a group of cays of which El Roque is the W, provides good anchorage to vessels with local knowledge under ordinary weather conditions. Four channels lead into Puerto El Roque. Vessels can anchor almost anywhere in this sheltered area. The best berth is in the center of the E part, in depths of 16 to 25m, within an area about 0.3 mile in radius. Care should be taken to avoid a coral spit extending 0.2 mile S from a small cay (11°57'N., 66°39'W.). El Roque has been reported to be radar conspicuous.

**Directions.**—To enter Puerto El Roque, a vessel should use Canal del Sur (11°56'N., 66°39'W.).

If approaching from the E, pass not less than 1 mile N of Cayo Frances (11°58'N., 66°39'W.) and round the prominent W extremity of El Roque at a distance of 0.5 mile. Then steer SE to pass 0.8 mile SW of El Roque and Cayo Namans (11°56'N., 66°40'W.).

**Isla de Aves** (12°00'N., 67°24'W.) lies about 28 miles WNW of the W cay of Islas Los Roques. It consists of two groups of low cays lying on dangerous coral reefs, 8.5 miles apart.

**Caution.**—Great care must be observed when approaching

this group of cays, especially from the N, and normally they should be given a wide berth. Depths of 200m or more are to be found about 0.3 to 1.8 miles off all sides. Vessels should observe the 200m curve and keep clear of the cays. Soundings must be taken continuously while transiting this area.

**2.9 Ave de Barlovento** (11°58'N., 67°26'W.), the E group, is an area of reefs and shoals nearly circular in shape. It is about 5 miles in diameter, with three cays on its SW part. A light is shown from the S cay. The E and N sides of the group consist of an almost continuous drying reef. Heavy breakers occur along this reef. Several channels on the W side of Ave de Barlovento lead from seaward between the reefs and shoals. They should not be attempted without local knowledge. Ave de Barlovento has been reported to be radar prominent.

**Ave de Sotavento** (12°00'N., 67°40'W.), the W group, is an area of reefs and shoals WNW of Ave de Barlovento. A large cay on its S side is covered with mangroves. An unbroken drying reef extends from this cay along the E and N sides of the group. A heavy surf breaks along the entire length of this drying reef, and foul ground extends almost 0.5 mile from it. Ave de Sotavento has been reported to be radar prominent. A light with a racon is shown from a NW cay.

There is a good clear passage, about 5.5 miles wide and with depths of 200 to 900m, lying between Ave de Sotavento and Ave de Barlovento.

**Bonaire**

**2.10 Bonaire** (12°09'N., 68°17'W.), the E island of the Netherlands Antilles, is rugged, uneven, and moderately high in its N part, but low and sandy in its S part. The trees on some parts of the island grow in clumps and have the appearance of Martello towers when first sighted. Brandaris, a peak rising 2.5 miles SSW of the NW extremity of the island, is 240m high and is often mistaken for a similar high peak at the NW end of Curacao. The coasts of this island are steep-to, with clear water, and free from dangers. The wind on the W coast of Bonaire is predominately E or SE, and there is hardly any swell alongside the piers or at the anchorage. When a hurricane passes close to the island, the wind becomes variable and the piers are then untenable. The currents in the offing and around the points of this island are generally W. On days with little wind, a weak current setting mostly parallel with the coast will be found in Rede Kralendijk, on the W side of the island. A local magnetic anomaly was reported (1947) to have been observed between 10 and 15 miles N of Bonaire. Bonaire has been reported to be radar conspicuous.

**2.11 Lacre Point** (12°01'N., 68°15'W.), the S extremity of the island, is low and fringed by a sand and coral reef. This point has been reported to be radar prominent.

A stranded wreck lies 1 mile ENE of Lacre Point. From Lacre Point, the E coast of the island extends 12 miles NNE to Boca Spelonk, the NE extremity of the island which is marked by a light. A shallow bay, available only to small craft, indents the coast about 4.5 miles N of Lacre Point.

**Ceru Grandi** (12°11'N., 68°15'W.), a peak 117m high, stands near the SE end of the mountain range located 3.8 miles SW of Boca Spelonk. From Boca Spelonk, the coast extends



**Bonaire Light**

0.5 mile N and 12 miles WNW to Malmok, the N extremity of the islands. Several small open bays lie along this section of coast. Three fairly high peaks stand within 2 miles S and SE of the N extremity of the island. Other high peaks stand within 3.3 miles and 4 miles SSE of the same extremity. From Malmok, the W coast of the island extends 5 miles S and 9 miles SE to Kralendijk. Fairly high hills border this section of coast a short distance inland.



**Kralendijk from SW**

**Klein Bonaire** (12°09'N., 68°19'W.), a low, rocky islet, is separated from the coast to the E by Rede Kralendijk, a narrow

channel, with a least navigable width of 0.2 mile.

A partially-obscured light is situated on the W end of the islet.

**2.12 Kralendijk** (12°09'N., 68°17'W.) (World Port Index No. 11780), the capital and government seat of Bonaire, is a small town with substantial trade and tourism.

**Depths—Limitations.**—The port provides alongside berthing for large vessels. The berthing facilities consist of two L-shaped piers, a ro-ro terminal, an airport pier and a small pier near the fresh water plant.

Bonoil Mooring, which consists of two mooring buoys, lies about 3 miles N of Kralendijk. For berthing information, see the table titled **Kralendijk—Berth Information**.

**Aspect.**—Landmarks consist of a fort, a memorial column, a radio tower, and a high-roofed house near the shore.

**Pilotage.**—Pilotage is compulsory, being available 24 hours. Requests for a pilot, giving the vessel's ETA 72 hours, 48 hours, and 24 hours in advance, should be sent through Curacao Coast Radio Station to the vessel's agent, who will relay the information to the terminal management. Pilots board 1 mile SW of the pier.

Pilotage is compulsory for arrival at the Bonoil Mooring; however, vessels may depart without a pilot by prior agreement.

**Contact Information.**—The pilots and Port Control can be contacted, as follows:

1. Call sign: Bonaire Pilots/Bonaire Port Control
2. VHF: VHF channels 11 and 16

**Anchorage.**—The coast of Bonaire is so steep-to that the only anchorage is in Rede Kralendijk. The roadstead can be approached either N or S of Klein Bonaire; however, the S approach is more convenient.

Anchoring is prohibited from the high water line up to a depth of 60m anywhere around Bonaire Island unless permission is granted by the harbormaster.

Should a W wind arise, it is advisable to get underway immediately and proceed to deep water. Strong SW winds, which make the anchorage unsafe, may be experienced in September, October, and early November.

It has been reported (1999) that as a result of Hurricane Lenny, depths may differ from those charted in the approaches to Kralendijk. Anchoring without the permission of the harbormaster is prohibited around the whole island between the HW line and the 60m depth contour.

**2.13 Zoutsteiger Pier** (Salina) (12°05'N., 68°17'W.) is a T-headed pier situated 4 miles S of Kralendijk. The pier is restricted to the loading of salt. Vessels of up to 40,000 dwt can be accommodated alongside in a depth of 13.7m. Pilotage is compulsory. The pilot boards 1.5 miles W of the pier.



Zoutsteiger Pier (for bulk salt)

**Goto Oil Terminal** (Bopec Terminal) (12°13'N., 68°23'W.) (World Port Index No. 11781), operated by Bonaire Petroleum Corporation, maintains a marine petroleum transfer terminal on the S coast of the NW part of Bonaire, 7.5 miles NW of Kralendijk. The berthing facility consists of two oil piers, each with a platform flanked by dolphins at its head. At No. 1 Pier, the platform is 40m long with a depth of 33.0m alongside; at No. 2 Pier, 0.3 mile E of No. 1 Pier, the platform is 15m long with a depth of 18.3m alongside.

There are no length or beam restrictions at either pier. Tankers up to 500,000 dwt can be accommodated at No. 1 Pier. No anchoring is possible. If the berth is occupied, vessels should remain within VHF range pending instructions.

**Pilotage.**—Pilotage is compulsory and is available 24 hours. The pilot boards about 1.5 miles SW of the piers.

**Regulations.**—An ETA should be forwarded 72 hours in advance, with a confirmation sent 48 hours and 24 hours before arrival.

Kralendijk—Berth Information			
Berth	Length	Depth	Remarks
North Pier	168m	10.0m (W side) 5.0m (E side)	Passenger vessels, situated 1 mile SSE of Palu Lechi, is of concrete construction; its W face is 68m long. Vessels with a maximum loa of 225m and up to 30,000 gross tons can be accommodated.
South Pier	120m	10.0m	Situated 0.2 mile S of the North Pier.
Ro-ro	—	5.0m	Located between the North Pier and South Pier
Flamingo Airport Pier	105m	4.8m	Tankers. Pier is T-shaped and can accommodate vessels up to 6,500 tons.

Kralendijk—Berth Information			
Berth	Length	Depth	Remarks
Pier	76m	—	Located NNW of Kralendijk. Projects from the coast near the freshwater plant. A dolphin and a mooring buoy lie at its head.

Tankers from Africa, the Mediterranean, or the Middle East should also give their ETA 10 days and 5 days in advance. Vessels should contact the pilot on VHF channel 16 when within 30 miles of the terminal.

Tugs are compulsory. Two tugs are used for vessels up to 150,000 dwt, three for vessels between 150,000 and 320,000 dwt, and four for vessels over 350,000 dwt.

**Contact Information.**—The terminal can be contacted, as follows:

1. VHF: VHF channels 13 and 16
2. Telephone: 599-717-8177
3. Facsimile: 599-717-8266

**Caution.**—Tankers should keep more than 3 miles off the radio station (12°13.1'N., 68°19.2'W.) to avoid danger from induction sparks, due to strong radiation from the transmitter.

## Curacao

**2.14 Curacao** (12°10'N., 68°58'W.), lying 35 miles off the coast of Venezuela, is the seat of government for the Netherlands Antilles. Four harbors in Curacao provide accommodation for vessels. Willemstad, the main harbor, lies on the S coast in the middle of the island. It consists of Sint Anna Baai Channel and the adjacent inner bay, which is known as Schottegat.

Caracasbaai, an open bay, lies 5 miles E of Willemstad and the harbor of Fuikbaai lies 2 miles farther E. Bullenbaai, another open bay, lies 8 miles W of Willemstad. Two piers are at the E side of the bay, naturally protected from prevailing wind and sea, with depths up to 14.2m alongside.

Curacao has a large oil refining complex. Shipping operations consist of tanker delivery of crude oil to the refineries, shipment of refined petroleum products, bunkering, general cargo, and passenger trade.

**Winds—Weather.**—The prevailing winds are ENE or ESE, at an average velocity of 11 to 16 knots. The average temperature is 28°C. The wet season, which has an annual rain fall of 675mm, lasts from mid-October to mid-February.

Hurricanes are a very rare occurrence.

**Tides—Currents.**—The tidal range in the ports and bays is about 0.3m. The currents in the vicinity of Curacao generally set to the W, but set strongly around the salient points. Along the SW coast, the currents may attain rates of 2 to 3 knots. Occasionally, the current may set E against the prevailing wind and it creates a short choppy sea that breaks on the shore even when the wind is light. It is important to give the coast a berth of at least 2 miles because of the currents. Local currents found within the bays are described under the principal description of those places.

**2.15** From Punt Kanon (Oostpunt), the SE extremity of Curacao, the coast extends 32 miles NW to Noordpunt and is

rocky, but generally low. The NE coast of Curacao has not been closely examined. It is exposed to heavy seas and swells and should be given a wide berth.

Sint Joris Baai (12°08'N., 68°48'W.), which leads into a lagoon, is the largest of a number of small indentations and inlets along this coast.

**Boca Plaja Canoa** (12°11'N., 68°52'W.), 4.5 miles NW of Sint Joris Baai, is a small indentation. Between Boca Plaja Canoa and Plaja Grande, 14 miles NW, the coast recedes to form Bocht van Hato. The main airport is situated at Hato, 5.3 miles W of Boca Plaja Grande. Boca Ascencion, a small cove, lies 2.5 miles S of Plaja Grande. The village of San Pedro stands 1.5 miles SSE of Boca Ascencion. From Plaja Grande, the coast extends 3 miles NNW and then 5 miles WNW to Noordpunt (12°24'N., 69°09'W.), the NW extremity of Curacao. A light is displayed from Noordpunt.

**Aspect.**—Curacao presents a barren aspect from seaward, with numerous hills standing along its entire length. Sint Christoffelberg, the highest hill, rises to a height of 372m and is the first object sighted in the approach from the N or W. This peak is often mistaken for Brandaris, which rises in the NW part of Bonaire. Sint Barbara, 194m high, is the first object seen in the approach from the E. The island of Curacao has been reported to be radar conspicuous.

Tafelberg, 230m high, rises 1.8 miles SE of Sint Christoffelberg and is also conspicuous. Sint Antonieberg, 172m high, stands 2 miles farther SE of Tafelberg and is prominent.

The NW coast from Noordpunt to Kaap Sint Marie consists of a succession of seldom-used small indentations. The middle part of the SW coast from Bullen Baai to Willemstad is fairly regular and steep-to. From Willemstad SE, the coast is low, backed by hills, and fairly steep-to.

**Westpuntbaai** (12°22'N., 69°09'W.), with the small village of San Pedro at its head, is entered 1.5 miles S of Noordpunt. A light is shown at its head. A large church in this village is visible between some high rocks. Small vessels can anchor off the village, but care is necessary because the shore bank is narrow. This anchorage should be approached with the church bearing 070° and with the anchor lowered to 50m. When the anchor takes hold about 0.1 mile offshore, back down and drop a second anchor to prevent swinging too close to the shore. Currents within the bay are negligible.

Temporary anchorage can be taken by small vessels in Knipbaai, about 1.5 miles S of Westpuntbaai.

**Boca Santa Cruz** (Sint Kruisbaai) (12°18'N., 69°09'W.), a small landlocked harbor used only by sailing vessels, is entered about 2 miles S of Knipbaai. It is entered on a course of 079° with the anchor lowered to 35m, steering for the S entrance point of the harbor. The anchor will take hold about 0.2 mile offshore.

Daaibooibaai, a small bay located 7 miles SE of Boca Santa Cruz, provides temporary anchorage to small craft.



**2.16 Bullenbaai** (Curacao Oil Terminal) (12°11'N., 69°01'W.) (World Port Index No. 11820) is an open roadstead which is spacious, with great depths in its central part. The largest vessels can enter the port safely. An oil-loading complex is situated on its E side.



**Bullen Bay (Bullenbaai Terminal)**

Gasoline and benzene produced at the Willemstad refineries are shipped from this terminal. Large oil tanks and the terminal facilities are prominent from the offing. At night, these installations are brightly illuminated.

**Winds—Weather.**—The high hills backing this bay provide protection from the prevailing winds.

**Depths—Limitations.**—Bullenbaai has been developed as a transshipment terminal at which tankers up to 530,000 dwt can discharge crude oil for loading and shipment by smaller tankers. There are six berths on the NE side of the bay. Each berth consists of a pier extending about 122m from the shore; at each pier head there is a platform flanked by berthing dolphins and with mooring dolphins nearer the shore. Depths alongside are approximate.

Berth information can be found in the table titled **Bullenbaai Berth Information**.

Bullenbaai Berth Information			
Berth	Depth alongside	Maximum vessel	
		Size	Length
No. 1 VLCC Jetty	21.0m	250,000 dwt	341m
No. 2 Jetty	12.8m	70,000 dwt	259m
No. 3 Jetty	17.0m	100,000 dwt	274m

Bullenbaai Berth Information			
Berth	Depth alongside	Maximum vessel	
		Size	Length
No. 4 Jetty *	30.5m	540,000 dwt	411m
No. 5 Jetty	19.2m	100,000 dwt	274m
No. 6 Jetty	28.6m	530,000 dwt	350m
* Situated 109m offshore.			

**Pilotage.**—Pilotage is compulsory and provided by Willemstad. The pilot may be contacted on VHF Channel 9 and embarks 0.5 mile S of Kaap Sint Marie.

**Regulations.**—An ETA should be forwarded 72 hours in advance, with any alteration of more than 6 hours sent immediately; the ETA should be confirmed 24 hours before arrival. Ships are berthed at night as well as by day, port side-to. Tugs are compulsory. Ships must be adequately ballasted to ensure good maneuverability. Ships should contact Fort Nassau Vessel Traffic Control Center on VHF channel 16 or 12 when approaching the terminal.

**Anchorage.**—There is no anchorage in Bullenbaai. Vessels awaiting berths are to remain in the vicinity within VHF radio range.

**St. Michielbaai** (12°09'N., 69°01'W.), a natural open bay protected from the winds and sea, lies 4.5 miles SE of Bullenbaai. An SPM buoy is moored close to the shore in a depth of 39m. This buoy provides a berth for vessels up to 350,000 dwt, which, because of draft, quarantine, or dangerous cargo restrictions cannot enter port. Vessels are moored stern-to with both anchors down and the bow to seaward.

**Willemstad (12°07'N., 68°56'W.)**

World Port Index No. 11810

**2.17** The port of Willemstad comprises Sint Anna Baai and a large inner bay called Schottegat. Together they form one of the best harbors in the West Indies. Administrative control is also maintained over Bullenbaai (paragraph 2.16), Caracasbaai (paragraph 2.18), and Fuikbaai (paragraph 2.19), which are described separately.

Asiento, an irregular peninsula on the N side of the Schottegat, is the site of several large oil refineries. Most of the general cargo berths are situated in Sint Anna Baai, repair and cargo berths on the E side of Schottegat, and tanker berths on the N and W parts of Schottegat.

**Tides—Currents**

The tidal rise normally is only 0.3m.

The currents off the entrance usually set to the W, but may be variable at times. The W current may attain rates up to 4 knots. The stronger currents may make it difficult for large vessels to enter because of the narrow entrance. Vessels are required to enter at slow speed, but with sufficient headway to maintain control. The current becomes negligible in Sint Anna Baai.



Schottegat Bay area



Queen Emma pontoon bridge

**Depths—Limitations**

Vessels having lengths up to 280m, beams up to 42.6m, and drafts up to 13.7m may transit Sint Anna Baai inbound or outbound. Occasionally, vessels 304m in length have entered the harbor. The mid-channel depths through Sint Anna Baai are 14.9 to 24m. The navigable portion of the entrance to the port is 264m wide and has a minimum depth of 14.9m.

Once past the pontoon bridge, which hinges on the W side of the bay and swings inward, berths line both sides of Sint Anna Baai and are used for general cargo, bunkering, and passenger vessels. For berthing information see the table titled **Willemstad—Sint Anna Baai Berth Information**.

The fixed road bridge, about 0.5 mile NNE of the entrance, has a vertical clearance of 55m.

Beyond Sint Anna Baai is an adjacent inner bay known as Schottegat. Schottegat has piers on its N side, used mostly by tankers berthing at the refinery and storage tank facilities. The E and deeper part of the harbor has depths of 10.6 to 18m in its middle and is used generally by ocean-going vessels.

Ten oil berths extend from Pier 1 in Baai van Valentijn (12°07'N., 68°56'W.), to the E side of the Asiento Peninsula, 1 mile E; dolphins are situated off some of these piers. Small tankers, which bring oil from Venezuela, use the westernmost piers. An obstruction, marked close E by a lighted buoy, lies 0.1 mile NE of No. 8 Pier at the SE extremity of the Asiento Peninsula.

Willemstad—Sint Anna Baai Berth Information			
Berth	Length	Depth alongside	Remarks
<b>Sint Anna Baai (East Side)</b>			
Grotewerf	200m	9.4m	Tugs, super yachts, and general cargo. Vessels up to 1,500 gross tons with a maximum beam of 17.6m can be accommodated.
Kleinewerf	125m	7.3m	Tugs, super yachts, and general cargo. Vessels up to 1,500 gross tons with a maximum beam of 17.6m can be accommodated.
Salazarwerf	140m	—	—
Jan Baarda Quay (Kade)	150m	7.3m	General cargo, tugs, and lumber. Maximum beam of 17.6m.
De Wilde Wharves	130m	—	Port Authority and general cargo
<b>Sint Anna Baai (West Side)</b>			
Matheywerf	198m	9.9m	Refrigerated cargo and cruise ships.
Westwerf N	170m	11.0m	General cargo and cruise vessels.
Westwerf S	145m	7.7m	General cargo and cruise vessels.

<b>Willemstad—Sint Anna Baai Berth Information</b>			
<b>Berth</b>	<b>Length</b>	<b>Depth alongside</b>	<b>Remarks</b>
Nieuwewerf	170m	10.1m	General cargo and cruise vessels.
Motetwerf	190m	10.1m	Tankers, bunkering, general cargo and cruise vessels.
Oranjewerf	90m	5.8m	Bunkers.
<b>Schottegat Bay</b>			
Prins Hendrik Werf	211m	10.4m	Tankers, bunkering, and cruise vessels.
Nicastia Werf	40m	6.0m	General and bulk cargo
<b>Admiral Brion Multipurpose Piers</b>			
No. 1/No. 2	310m	10.2m	General cargo.
No. 3/ No. 4	310m	10.2m	General cargo (No. 3 end). Ro-ro vehicle access
No. 5/No. 6	290m	10.2m	General cargo (No. 5 end). Ro-ro vehicle access
Brion (North) 1 and 2	181m	7.0m	General cargo. Can accommodate vessels up to 8,000 gross tons.
<b>Container Terminal</b>			
No. 1	155m	12.2m	Containers and general cargo.
No. 2	155m	12.2m	Containers and general cargo.
No. 3	155m	12.2	Containers, general cargo, andro-ro.
<b>Otrabanda (Sea front)</b>			
Mega Pier	144m	15.0m	Cruise liners, bunkering, and vessels waiting for inner harbor. Can accommodate vessels up to 145,000 gross tons.

<b>Willemstad—Emmasted Refinery Berth Information</b>				
<b>Berth</b>	<b>Maximum Vessel</b>			
	<b>LOA</b>	<b>Draft</b>	<b>Beam</b>	<b>Size</b>
No. 1	177m	8.2m	42.6m	25,500 metric tons
No. 2	175m	9.1m	42.6m	25,500 metric tons
No. 3	175m	9.3m	42.6m	25,500 metric tons
No. 4	236m	11.5m	42.6m	4,000 metric tons
No. 5	259m	12.8m	42.6m	100,000 metric tons
No. 6	228m	11.4m	42.6m	54,000 metric tons
No. 7	170m	9.4m	42.6m	25,500 metric tons
No. 8	259m	12.8m	42.6m	100,000 metric tons
No. 9	259m	10.2m	42.6m	40,000 metric tons
No. 10	259m	6.4m	42.6m	40,000 metric tons

At the E part of Schottegat is Admiral Brionwerf, which has six berths providing a total of 915m of docking space, with

a depth of 10.4m alongside. Two special platforms for ro-ro and container ships are situated close S. Vessels with drafts of



Willemstad—Conspicuous chimneys close W of harbor entrance



Queen Juliana Bridge (background)

7 to 10.1m can be handled. These platforms are also the mooring berths for ferries running between Curacao, Venezuela, Aruba, and Bonaire.

A container terminal, including some ro-ro facilities, is situated close S of Admiral Brionwerven and has a depth of 10.4m



Mega Pier

Mega Pier lies W of the Sint Anna Baai entrance. For berthing information see the table titled **Willemstad—Sint Anna Baai Berth Information** and the table titled **Willemstad—Emmasted Refinery Berth Information**.

**Aspect**

Sint Anna Baai may be identified from a great distance by Drie Gebroeders, a group of three hills which stand between 1.8 miles and 3 miles NW of its entrance. In addition to two forts at the entrance to Sint Anna Baai, Fort Amsterdam (Nassau) on the S side of Schottegat, a little over 0.8 mile NNE of Waterfort, is readily identified. The fixed bridge spanning Sint Anna Baai is situated about 0.4 mile SW of Fort Amsterdam (Nassau). A prominent chimney painted yellow, with a black top, stands near the coast about 1 mile WNW of Riffort. Another chimney stands close E of it. A conspicuous stadium stands on the W side of the entrance to Sint Anna Baai, and a conspicuous windmill 1.3 miles ENE.

The markers of the range line, bearing 042°, were reported (1998) to be difficult to identify. More recent reports (2001) report no difficulties identifying this range. The range established on the W side of Sint Anna Baai, in line bearing 023°30', provides the preferred approach.

**Pilotage**

Pilotage is compulsory for all vessels over 50 grt. The pilot boards about 1 mile SW of the piers. An ETA should be forwarded 48 hours and 24 hours prior to arrival through Curacao Coast Radio Station.

The pilots can be contacted, as follows:

1. VHF: VHF channels 14 and 16
2. Telephone: 599-9-434-5999
3. Facsimile: 599-9-461-8479

**Regulations**

Fort Nassau, the harbor traffic control center, should be contacted when within range on VHF channels 16 and 12. A 24-hour watch is maintained.

Tugs are compulsory for dry cargo vessels more than 228m in length berthing at Willemstad. Tankers up to 244m in length

or more require three tugs; those over 16,000 grt and up to 213m in length require two tugs. Tankers 3,000 to 16,000 grt require 1 tug.

Vessels bound for Willemstad must give advance notice to the harbormaster as to the amount and nature of explosives on board. Vessels with such cargo are not allowed to enter Sint Anna Baai and are usually sent to Caracasbaai for discharge.

Both anchors should be ready for immediate use. Any defects of engines, steering gear, anchor gear, or any other defect, which will affect maneuverability, should be reported to the harbormaster prior to entering.

**Signals**

**Vessel Movement Signals.**—The signal station at Fort Nassau (12°07'N., 68°56'W.) displays signals governing the movement of vessels within Sint Anna Baai and Schottegat, as described in the table titled **Vessel Movement Signals**.

**Bridge Signals.**—The following signals are given from the pontoon bridge at the entrance to Sint Anna Baai:

1. Blue flag, by day, or one blue light, at night—The bridge will be opened in about 5 minutes.
2. One long blast on siren (tone is muffled from 2200 to 0600)—The bridge will be opened within 1 minute and the land traffic must be stopped.
3. Four long blasts on siren—The bridge either cannot or will not be opened.

The following signals for the bridge attendant are displayed at the harbor office:

Day	Night	Meaning
Green flag	One green light	The bridge attendant must close the bridge.
Red flag	One red light	The bridge attendant must keep the bridge open.

Vessel Movement Signals		
Day	Night	Meaning
Black ball (half mast)	One white light	One or more ships may depart.
Black ball	Two red lights	The bridge will be opened for one or more outbound ships.
Black ball and red flag	Two red lights	The bridge will be opened for one or more outbound ships.
Red flag *	One red light *	The last outbound ship is entering Sint Anna Baai and following ships must not enter the bay.
Red flag and black cone	One red light over two white lights	The last outbound ship is passing Nieuwe Wharf and the bridge will remain open for one or more inbound ships.
Black cone	Two white lights vertically disposed	In the event the bridge is closed, it will be opened for one or more inbound ships; in case the bridge is already open for outbound ships, the last ship is passing the bridge.
Green flag and black cone	One green light	The bridge is open for one or more inbound ships.
Green flag	One green light	The last inbound ship is passing the buoy and ships that follow are not allowed to enter.

Vessel Movement Signals		
Day	Night	Meaning
Red flag over green flag	One red light over one green light	The harbor is closed because of a maneuvering ship.
Green flag over red flag	One green light over one red light	The harbor is closed because of unexpected circumstances.
Black cylinder	Two green lights vertically disposed	A ship is shifting berth
International Answering pennant or Morse code signal "R"	Morse code signal "R"	Request from a ship for a pilot or a tugboat has been seen or heard.
Code flag "N"	Yellow flashing light	A naval ship or ships may enter or leave the harbor.
* Signal will be shown until last ship has passed the bridge.		
<b>Note.</b> —The International Answering pennant is not shown simultaneously with other signals and is not shown for a period to exceed 1 minute.		

**Harbor Signals (made by vessels).**—The following signals may be given by vessels:

1. A black ball, by day, or one white light over one red light, at night—The ship wants to shift.
- Note.**—Either signal is to be followed immediately by a long blast on the whistle or siren. It can only be given when the signals at Fort Nassau indicate that the harbor is clear.
2. Two long blasts on whistle or siren—The ship wants a pilot immediately.
3. Three long blasts on whistle or siren—The ship requests the bridge to be opened.
4. Four long blasts on the whistle or siren—The maneuvering of the ship has been stopped for the time being.
5. Ten short blasts on whistle or siren—There is a fire aboard the ship.
6. Morse code signal "K" on whistle or siren—Ship requests permission to block Sint Anna Baai Channel, preparatory to mooring or unmooring.
7. Morse code signal "B" on whistle or siren—Ship reports Sint Anna Baai Channel now open again.
8. Morse code signal "X" on whistle or siren—A tug is requested.
9. Morse code signal "V" on whistle or siren when navigating in Sint Anna Baai—Ship is blocking Sint Anna Baai.
10. Morse code signal "V" on whistle or siren when navigating in the Schottegat—Ship is unmaneuverable; other ships should keep clear.

All vessels are prohibited from sounding their whistles or sirens in the harbor area between 2200 and 0600. The limits of the above harbor area extend from Nieuwe Wharf to the entrance. During these hours the following signals will be displayed:

1. Two red lights (vertically disposed)—Ship requests permission to get underway.
2. Extinguishing of above lights—When leaving, request that the bridge be opened. In the event the ship is entering or shifting, that the harbor is now clear again.

**Storm Signals.**—The following storm signals are shown from the lighthouse at Riffort:

1. Red flag with white background—Storm expected

over Curacao.

2. Two red flags with black background or one white light between two red lights (vertically disposed)—Hurricane expected over Curacao.

3. Green pennant below Signal 2—Hurricane exists or is expected in the Caribbean Sea between 60° and 65°W.

4. Black pennant below Signal 2—Hurricane exists or is expected in the Caribbean Sea between 65° and 70°W.

**Current Signals.**—Two current meters are attached to the two lights situated 0.1 mile and 0.2 mile W of Waterford Light, which stands on the E entrance point of Sint Anna Baai. A third meter, visible only from within Sint Anna Baai, is situated on the inner wall of Waterford. The direction and strength of the current is indicated by colored lights, displayed vertically, from the meters as follows:

1. Red, white, red, green—More than 2 knots, west-going.
2. White, red, green—1.5 to 2 knots, west-going.
3. Red, green—1 to 1.5 knots, west-going.
4. Green—0 to 1 knot, west-going.
5. Green, orange—0 to 1 knot, east-going.

It was reported (1995) that the above current meters are inoperative. It has been reported (2001) that the signals for vessel movement in the harbor are not always in use and that the pilot controls the use of signals.

### Anchorage

Generally, there are no outer anchorage areas in Willemstad Harbor. There is an anchorage area in Willemstad, in the SW area of Scottegat Bay there is a dolphin with a mooring buoy on each side available as a waiting berth subject to the Harbor Master's permission, depth 12.9m, the distance between each buoy and dolphin is about 350m.

### Directions

Approach the entrance with the lighted beacons in line, bearing 023°30'. This course leads between the lighted beacons on either side of the entrance. The inbound range is also marked

as white boards with red stripes and a red diamond shape on the top of each. The aft range marker has been reported (2011) as inconspicuously located mid-way up a hill. Having cleared these beacons, alter course passing in mid-channel through the pontoon bridge opening. Maintain sufficient headway to overcome any adverse effect of the wind and current. The traffic signals must be strictly observed, because with vessels berthed on both sides of Sint Anna Baai, the fairway is too narrow for large vessels to safely pass each other.

**2.18 Caracasbaai** (Caracas Bay) (12°04'N., 68°52'W.) (World Port Index No. 11800), an open roadstead, lies about 5 miles ESE of Willemstad and has oil berthing facilities for shipping fuel oil and diesel oil in bulk. Passenger and cargo vessels also use the harbor.

**Winds—Weather.**—The NE trades are constant except during the months of August through October, when they become light and variable. The currents, which are strong at times, set NW across the bay entrance.

**Depths—Limitations.**—The harbor is dredged to a depth of 14.3m. Vessels with a maximum length of 320m and a draft of 13.7m may be accommodated.

Berthing facilities, on the E side of the bay, consist of Pier No. 2 and Pier No. 3, about 0.2 mile SSE. These T-headed piers have concrete quays and are flanked by dolphins. Vessels berth port side to. The piers also serve as a passenger terminal. Pier No. 2 has a depth of 14.3m alongside; Pier No. 3 has a depth of 13.7m alongside.

Tugs are based at Willemstad and are provided automatically for berthing only. Two tugs are used for tankers more than 20,000 grt and for passenger liners and cargo vessels more than 30,000 grt.

The 10m curve lies up to 135m off the N and E shores; outside this curve the depths increase sharply.

**Aspect.**—Tafelberg (Santa Barbara), a 196m hill standing about 1.8 miles E of Caracasbaai, and Fort Beekenburg, on the E side of the bay, are good landmarks from seaward. A former quarantine building standing on the E entrance point is prominent. The large tanks and the terminal facilities are visible for a considerable distance and are brightly illuminated at night.

**Spaanse Haven** (12°04'N., 68°51'W.) is a narrow channel leading into Spaanse Water, an irregular-shaped harbor used solely by yachts.

The obscure entrance is identified by a cluster of oil storage tanks standing on top and fringing the side of the hill that forms the left bank of the entrance.

**Pilotage.**—Pilotage is compulsory and is available 24 hours. The pilot boards 1 mile off Lijhoek (12°04'N., 68°52'W.).

**Anchorage.**—The depths in the bay are too great for anchoring. Vessels awaiting a berth should remain well seaward until ordered to come alongside.

**2.19 Fuikbaai** (12°03'N., 68°50'W.), a narrow lagoon, is used as a phosphate-exporting center. The entrance has a least navigable width of 44.8m. Vessels with a length in excess of 116m or a draft in excess of 7.3m cannot enter. The depth alongside the loading berth is 8.5m. There is a berth, 25m long, available for handling explosives or other cargo; however, only small vessels with a maximum draft of 4.3m can moor alongside. Vessels of greater draft can moor with the help of floats

placed between the ship and the quay.

Two lighted beacons, in line bearing 027°30', lead into the lagoon.

Generally, there is a strong W current in the approach. During some months, usually August through October, strong E currents are encountered. These currents are of great importance to vessels entering the lagoon.

**2.20 Newport** (Nieupoort) (12°03'N., 68°50'W.) is a small port lying on the NE side of the lagoon, just N of Fuikbaai. It has a small phosphate wharf, with an alongside depth of 8.5m. A chimney and a flagstaff are prominent landmarks.

**Pilotage.**—Pilotage is compulsory. The pilot boards 0.5 mile S of the entrance or in Caracasbaai. The harbor is entered by day only. The vessel must be properly ballasted to ensure safe maneuvering.

The coast between Fuikbaai and Punt Kanon, about 5.5 miles E, is low and bordered by three lagoons. This section of coast is steep-to and depths of over 200m are to be found within 0.5 mile of the shore. To avoid damage to the beaches, vessels are requested to proceed at a moderate speed when within 3 miles of the S coast of Curacao.

**Klein Curacao** (11°59'N., 68°39'W.), lying 6 miles ESE of Punt Kanon, is a low, bare, flat island. It is steep-to, especially on the E side. This island is radar prominent.



Klein Curacao Light (right side)

## Aruba

**2.21 Aruba** (12°30'N., 70°00'W.), on which only sparse vegetation grows, lies with Punta Basora, its SE extremity, located 42 miles W of the N extremity of Curacao. The island is slightly hilly, with a few isolated peaks.

The NE coast of Aruba is rocky and indented by small coves; it is exposed to heavy breakers and should not be closely approached. The SW and W coasts are low. Much of the SW coast is fronted by barrier reefs, with lagoons inside them. Some of the reefs are covered with mangroves. Aruba has been reported to be radar conspicuous.

**Winds—Weather.**—Although Aruba is generally considered to be outside the hurricane belt of the Caribbean, destructive hurricanes struck the island in 1954 and 1955. The prevailing NE winds carry dense smoke seaward from the oil refineries, and at times the resultant haze may be such that the



Hooiberg (Haystack) from W

island is not visible until within 6 miles.

**Tides—Currents.**—In the vicinity of Aruba, the currents usually set W at a rate of 0.5 to 1 knot, although around the points greater rates may be attained. Off Sint Nicolaas Baai, when the trade winds are strong, the currents may attain rates of up to 3 knots. When the trade wind is weak or with variable W winds (usually October to December) the currents may set E and attain a rate of up to 2 knots.

**Aspect.**—Jamanota and Hooiberg, the two highest peaks, rise to elevations of 176 and 167m, respectively, 6 miles and 9.5 miles NW of Punta Basora. These peaks are good landmarks from seaward, but become partially obscured by the dense smoke from the oil refineries at times.

**Caution.**—Many small fishing vessels may be found anchored off the S coast of Aruba at distances up to 3 miles offshore. Some of the vessels may display no lights.

To avoid the risk of pollution to the beaches on the W and SW coasts, tankers are advised not to anchor offshore between the entrance to Haven Barcadera and the N extremity of the island.

It was reported (1947) that a local magnetic disturbance occurred between Aruba and the mainland.

**2.22 Ceru Colorado** (12°25'N., 69°52'W.), a very dark hill, rises close NW of Punta Basora and has been reported to be radar conspicuous.

From Ceru Colorado, the E side of Aruba extends 4.3 miles NNW and then 4.8 miles NW to Noordkaap. Depths of 18m and less lie within 1 mile S, 0.8 mile E, and 1.5 miles NNE of

Punta Basora. Two shoal heads, with depths of 9m and 10m, respectively, lie 0.5 mile ENE and 1 mile NE of Punta Basora.

Two water towers stand 0.5 mile N and a conspicuous tank is situated 3 miles NW of Ceru Colorado.

A range of hills, with peaks between 143 to 176m high, extends 4.3 miles S from a position located 0.5 mile S of Noordkaap.

From Noordkaap, the coast extends 8 miles NW to the N extremity of the island. California, about 0.5 mile ESE, is the NE extremity of Noordwestpunt, a peninsula forming the NW extremity of the island.

From Punta Basora, the SW coast of Aruba extends about 1 mile W to a low sandy point from which a barrier reef, on which there are several low cays, extends about 0.8 mile W to Indiaanskop, a small island, marked by a light. The barrier reef, with a long, narrow island on it, then extends about 0.5 mile NW to the S entrance to Sint Nicolaas Baai.

A channel, 135m wide, has been dredged through the barrier reef about 0.5 mile NW of Indiaanskop; there is a least depth of 12.8m in the fairway of the channel. Lighted beacons lie on each side of the entrance to the channel. A lighted range stands 0.4 mile NNE of Indiaanskop and in line, bearing 087°, leads through the dredged channel.

On the N side of the lagoon, 0.5 mile NNW of Indiaanskop, there is a pier, with 91m of berths, flanked by dolphins. It is used by dry cargo vessels with drafts up to 9.4m. A turning area, about 180m wide, lies S of the pier and has a least depth of 9.7m.



### Sint Nicolaas Baai (San Nicolas) (12°26'N., 69°54'W.)

World Port Index No. 11830

**2.23** The port of Sint Nicolaas Baai, which is situated 2.5 miles WNW of Punt Basora, has an oil terminal with a large refinery. It imports and transships crude oil and exports refined products. Protected on its SW side by a long, narrow island, and a reef; the port can be identified, by day, by the large oil tanks and, at night, by the ample lighting. Three conspicuous white chimneys stand on the shore in the SE part of the port. An aluminum-colored chimney, which stands near three yellow tanks, is situated about 0.5 mile ENE of the NW entrance and is very conspicuous.

The controlling depth in the entrance is 13.4m. Maximum arrival draft is 12.2m, while maximum departure draft is 12.5m.

**Tides—Currents.**—The tidal rise normally is about 0.2m and the maximum rise is about 0.5m. The movement is semi-diurnal. The maximum current near the terminal sets W at a rate of 1 knot.

The W currents found just off Sint Nicolaas Baai and the Reef Berths can reach a velocity of 3 knots during the prevailing NE winds. However, during certain times of the year with variable winds, the current may set vessels to the E.

In general, the currents can be unpredictable. Countercurrents also may exist from 0.2 to 2 miles off the coast.

**Depths—Limitations.**—Vessels berthing at the principal piers enter by the NW entrance and depart by the S entrance.

West Pier, is L-shaped, and situated on the N side of the bay, 0.4 mile within the NW entrance; there are dolphins up to 0.2

mile W of the W end of the pier head. The pier can was reported not in use in 2013. There is a boat quay situated close W of the root of West Pier.

Reef Berth No. 1 and Reef Berth No. 2 project from the shore 0.5 mile and 1 mile, respectively, WNW of the NW entrance to Sint Nicolaas Baai. Each is a T-headed jetty with off-lying dolphins for berthing large tankers. Vessels berth port side-to. Vessels should be ready to get underway on short notice. For berthing information see the table titled **Sint Nicolaas Baai—Berth Information**.

**Pilotage.**—Pilotage is compulsory for merchant vessels. The pilot boards about 1.0 mile WSW of the NW entrance channel for vessels calling at the inner harbor or dry cargo piers. Vessels calling at Reef Berth No. 1 or Reef Berth No. 2 embark the pilot about 1.5 miles SW of the respective berth. Day and night service is provided.



Sint Nicolaas Baai (San Nicolas)

The pilots can be contacted (call sign: Sint Nicolaas Pilot Station) on VHF channel 16.

Sint Nicolaas Baai—Berth Information					
Pier/Berth	Maximum Vessel				Remarks
	Draft	LOA	Beam	Size	
West Pier	10.1m	198m			L-shaped pier situated on the N side of the bay, 0.4 mile within the NW entrance. Reported (2013) not in use.
Coke Berth	12.5m	244m		75,000 dwt	
Sulphur Berth	9.4m	182m		50,000 dwt	Mooring dolphins each end. Reported (2013) not in use.
HDS Pier	9.6m	213m	28m		
No. 1 Reef Berth (Coastal and reef)	22.8m	365.8m		300,000 dwt	
No 2. Reef Berth (Wickland)	32.3m	426m	No limit	No limit	
Valero Tanker Berths					
1 (N side)	11.8m	225m	33.5m	50,000 dwt	
1 (S side)	11.8m	227m	33.5m	50,000 dwt	
2 (N side)	12.2m	219m	36.0m	60,000 dwt	
2 (S side)	11.5m	243m	36.0m	60,000 dwt	

Sint Nicolaas Baai—Berth Information					
Pier/Berth	Maximum Vessel				Remarks
	Draft	LOA	Beam	Size	
3 (N side)	12.2m	259m		80,000 dwt	
3 (S side)	12.5m	274m	41.0m	90,000 dwt	

**Regulations.**—Local harbor regulations are in force and a copy should be obtained from the facility or the agent.

**Anchorage.**—Anchorage may be taken on the narrow shore bank outside the harbor, but it is advisable to employ a pilot. Pilots are available for daylight anchoring only. As a rule, vessels should not anchor E of Indiaanskop because the rough sea found there makes it difficult for the pilot boat and tugs to go alongside.

Designated anchorage areas, which can best be seen on the chart, exist off Sint Nicolaas Baai.

Anchorage is prohibited between the coast and an arc with a radius 0.5 mile centered 0.5 mile WNW of the NW entrance point of the channel.

It has been reported that good anchorage can be taken, in a depth of 56m, sand and coral, with the light on the SE side of the N entrance bearing 322° and the signal station bearing 016°.

Vessels over 20,000 dwt should proceed to a position about 10 miles WSW of the harbor entrance and anchor, in depths of 36 to 43m.

**Caution.**—Due to traffic at the refineries, it is recommended that vessels remain at least 2 miles off the coast when transiting this area.

**2.24 Commandeurs Baai** (12°27'N., 69°57'W.) lies within the lagoon immediately NW of Sint Nicolaas Baai. The entrance to Commandeurs Baai, at the W end of the lagoon, is formed by a narrow channel. This channel has a least depth of 2.7m and leads through the barrier reef. There are depths of 3 to 12m in the navigable part of the lagoon. It is used by local fisherman and only suitable for small craft. An obstruction with a depth of 3.3m lies in the channel about 80m NE of the channel buoy.

**Spaans Lagoen** (12°28'N., 69°58'W.), located 2 miles NW of Commandeurs Baai, is marked by a prominent group of tall chimneys standing on its NW entrance point.

**Pilotage.**—Pilotage is compulsory and always available. The pilot boards about 0.5 mile W of the Reef Berths.

**Anchorage.**—Anchorage can be taken, in a depth of 50m, off the barrier reef, with the group of chimneys bearing 346°.

**Caution.**—A submarine cable, which may best be seen on the chart, lies across the W entrance, about 0.2 mile within the

entrance. A submarine pipeline, which may best be seen on the chart, lies across the entrance, close E of the cable.

**2.25 Haven Barcadera** (12°29'N., 70°00'W.) is situated about 2 miles NW of Spaans Lagoen and about 3 miles SE of Oranjestad.

The harbor comprises a deep-water quay, with a dredged approach through the barrier reef; the quay has alongside depths of 8.9 to 10.6m. Vessels up to 185m in length can be accommodated. The harbor entrance is 183m wide with a least depth of 11m in the channel.

The harbor and approach are marked by navigational aids. Lighted range beacons, bearing 093°, lead through the barrier reef into the harbor.

**Winds—Weather.**—Winds slightly S of E usually prevail and, if strong, affect the maneuvering of vessels in the vicinity of the quay. The wind usually diminishes before dawn and the first hours of daylight are the most favorable for entering. Vessels enter and depart 24 hours. However, under favorable circumstances, the maneuvering time will be shorter and therefore early morning berthing is desirable.

**Tides—Currents.**—To the W of the barrier reef, the current sets W at a rate of 1 to 2 knots, but rarely exceeds 3 knots. On occasion, an E set may be experienced at a rate of no more than 2 knots.

**Pilotage.**—Pilots are available 24 hours and can be obtained from Oranjestad. A tug can be obtained from Oranjestad and its services are strongly recommended.

**Paarden Baai (Oranjestad) (12°31'N., 70°02'W.)**

World Port Index No. 11840

**2.26** Paarden Baai, a narrow bay protected on its W side by the barrier reef, is the harbor area for Oranjestad, the administrative seat of government for Aruba.

<p><b>Oranjestad Home Page</b>  <a href="http://www.arubaports.com">http://www.arubaports.com</a></p>
-----------------------------------------------------------------------------------------------------------

Oranjestad Berth Information			
Berth	Max. LOA	Max. draft	Remarks
B, C, and D (Cruise Terminal)	527m	9.9m	Cruise ships.
E (Easthaven)	169m	9.1m	Cruise ships.
F (Easthaven)	180m	8.5m	Cruise ships.

Oranjestad Berth Information			
Berth	Max. LOA	Max. draft	Remarks
G (Westhaven)	150m	8.5m	Cruise and ro-ro vessels.
H (Westhaven)	200m	8.5m	Cruise ships and ro-ro vessels. Alongside depth of 10.3m.
CK	250m	9.8m	Containers vessels. Alongside depth of 11.2m.



#### Parden Baai—Container Terminal

**Tides—Currents.**—Off the port there is a W current. It has a rate of about 1 to 2 knots, but rarely exceeds 3 knots. There are times when there is no current or an E set may be experienced. This set attains a velocity of 2 knots at times. On occasions, when the W set is strong, an E set of 0.5 knot may be experienced within the harbor, but this is rarely noticed because the wind is much stronger and in the opposite direction.

**Depths—Limitations.**—Vessels usually enter through the N channel and depart through the S channel. Both channels have a least width of 0.1 mile. The N channel has a least depth of 11.2m and the S channel has a least depth of 10m. Vessels up to 250m in length can enter, but their draft should not exceed 10m. Minimum drafts are in force for tankers arriving or sailing in ballast. The use of tugs is advisable for large vessels and vessels in ballast.

The berthing facilities consist of two basins, Westhaven and Oosthaven, separated by a projecting wharf. The main wharf is situated SE of the basins.

Both basins have berths, 167m and 198m long, with least depths of 8.5m alongside. The main wharf, 527m long, extends

SE from the SE entrance point of Oosthaven. There is a least depth of 9.9m alongside the SW part of this wharf, and 4.9m alongside the SE part. The container terminal has depths of 11 to 11.2m alongside.

The entrance channel, the navigable part of the harbor, and the harbor berths have depths of 11m that are maintained by dredging. Berth

A large square concrete mooring dolphin, marked by a light, has been reported (2007) established about 75m SW of the end of Berth B off the main wharf.

The head of Westhaven comprises a ferry terminal and a ro-ro berth. A container berth is situated NW of the harbor office, which stands at the entrance to Westhaven. A wreck, marked by a yellow buoy, is found in the channel approximately 165m W of the head of the pier containing charted Berth H.

**Aspect.**—Oranjestad can be identified by a conspicuous water tower with a prominent church standing close NW of it.

**Pilotage.**—Pilotage is compulsory for vessels over 50 grt and is available at all times. Request for pilot should be made through Curacao Coast Radio Station until within VHF range,



**Parden Baai—Westhaven—Berth H (left) and Berth G (right)**



**Parden Baai—Tanks in Westhaven**



**Parden Baai—Berth G (left side) and Berths F and E (right inlet)**



**Parden Baai—Berth E (Oosthaven)**



**Parden Baai—Harbormaster Tower**



**Parden Baai—Cruise Terminal (Berth C) from NW**



**Parden Baai—Cruise Terminal (Berth C) from SE**

giving 48 hours notice of ETA. Oranjestad Port Radio maintains a 24-hour watch on VHF channels 11, and 16. The pilot boards in position 12°31.3'N, 70°04.1'W. Vessels should approach this channel as near as is prudent and make a lee for the pilot boat.

**Anchorage.**—Paarden Baai provides anchorage W and S of the main wharf.

Anchorage, suitable even for the deepest draft vessels, are situated outside the protecting reef along the length of the W and SW coast. Because of the sharply shelving nature of the bottom in this area, it is recommended that the services of a pilot be obtained when letting go and weighing anchor.

**Caution.**—Within the bay, the trend of the channel is almost across the direction of the prevailing wind, so that large vessels and those in ballast must exercise great caution, especially at night, to avoid the reef to leeward. Some difficulty may be experienced in berthing at the main wharf when the trade wind is blowing, and it is then preferable to enter either Westhaven or Oosthaven, head to the wind.

It was reported (1991) that lesser depths than charted exist at all Oranjestad harbor berths. A dangerous wreck lies about 195m SW of the main pier and is marked by a buoy close NE.

**2.27 Manshebu** (12°32'N., 70°04'W.), also known as Westpunt, is the W extremity of Aruba. This point has been reported to be radar prominent.

**Druif** (12°32'N., 70°04'W.), the site of a former bulk oil terminal and refinery, stands on the SW side of the point. This area can be identified by two conspicuous hotels.

From Manshebu, the coast extends 2.8 miles N and then 2.5 miles NNW to the N extremity of Aruba. This section of coast has no barrier reef, but is fronted by a shorebank which extends up to 0.8 mile seaward in places. Depths of less than 20m lie up to 1 mile offshore.

**Anchorage.**—Vessels awaiting instructions are often requested to anchor W of Noordwest Punt in order to conserve bunkers.

A restricted anchorage area, the limits of which are shown on the chart, extends W from the coast between Manshebu and Basiruti. It is reserved for the use of vessels carrying out repairs, tank cleaning, etc. It is the only anchorage in the vicinity of Aruba where these operations can be effected by VLCCs and ULCCs.

A pilot must be employed for these anchorages, as care is needed not to obstruct the approach to Oranjestad and to avoid an abandoned submarine cable extending W and N from the coast close S of Basiruti.

**Caution.**—Offshore dangers lying on the coastal bank and positioned relative to Pos Chikitu (12°33.7'N., 70°03.7'W.) are, as follows:

1. A stony shoal depth of 1.5m—0.5 mile W.
2. A 2.2m shoal—0.6 mile NW.
3. A dangerous wreck—0.8 mile NNW.

In addition, stranded wrecks lie 1 mile and 2.5 miles N of Pos Chikitu; each is marked by a lighted buoy moored close SW. A wreck, with a least depth of 6.1m, lies close SSE of the N stranded wreck.

## Coast of Venezuela—Punta Penas to Punta Escarceo

**2.28** The coast between **Punta Penas** (10°44'N., 61°51'W.) and Cabo Mala Pascua, 67 miles W, is backed by mountains more than 1,200m high and completely covered by trees. Cabo Mala Pascua is not prominent. Large spurs branch from the central ridge and terminate in bold points, forming deep gorges at the heads of the bays. Generally the coast is bold and rocky, with no off-lying dangers. Rocks fringe this section of coast in places, but usually lie close offshore. Cabo Tres Puntas, located 17.3 miles E of Cabo Mala Pascua and marked by a light, is bold and salient. Two conspicuous peaks stand close together, 6 miles ESE of this cape. The W peak, which is the highest, rises to an elevation of 1,257m.

**Ensenada Unare** (10°44'N., 62°45'W.), entered 3 miles WSW of Cabo Tres Puntas, is a small roadstead, with depths of less than 5.5m, extending 0.3 mile from both entrance points. Some shelter is provided in the lee of the NE entrance point, which can be identified by a small conical hill surmounting its outer part. The shore of the bay consists of a white, sandy beach, 1.8 miles long, through the middle of which flows a stream. Landing in Ensenada Unare is best effected in the lee of the NE entrance point, but a surf usually makes it difficult.

**Puerto Rio Caribe** (10°42'N., 63°07'W.), a small town, stands on the shores of Bahia Caribe, about 4 miles W of Punta Frayle (10°43'N., 63°02'W.), a low rocky point.

**Anchorage.**—Small craft with local knowledge can anchor in this bay, in depths 11 to 13m, in the lee of the E entrance point.

**2.29 Morro Puerto Santo** (10°43'N., 63°10'W.), a T-shaped headland, is about 90m high at its outer part and is joined to the mainland by a low sandspit on which the village of Puerto Santo stands. The headland, with Isleta del Puerto Santo, marked by a light, lying close off its W side, appears detached from seaward and provides a good landmark. Monte Puerto Santo, a 1,058m high peak, rises 6 miles S of the headland and is prominent.

Anchorage can be taken W of the isthmus, in depths of 6 to 10m, mud, keeping W of the meridian of the W side of Isleta del Puerto Santo and between 0.2 mile and 0.4 mile off the S shore of the bay.

The coast between Morro del Puerto Santo and Punta Hernan Vasquez is bordered by depths of less than 11m, up to 1 mile offshore.

**2.30 Puerto Carupano** (10°40'N., 63°15'W.) (World Port Index No. 12260) consists of a pier protected by a 694m breakwater on its NE side. Only vessels of limited draft can be accommodated.

Vessels approaching from the E or W should keep in depths of 11m or greater until N of the breakwater because of the foul ground lying off the coast E of Punta Hernan Vasquez and because of the many dangerous shoal heads that lie up to 1 mile offshore, W of the breakwater head.

Morro del Puerto Santo and Punta del Tacquien are the most salient and prominent points to be seen from seaward. The radio masts standing 0.8 mile S of the breakwater, the cathedral, and the church with twin spires situated in the town are all

prominent marks.

**Depths—Limitations.**—There are general depths of 7.9 to 9.1m in the approach to the port and a depth of 8.5m over the bar. Vessels intending to moor alongside the pier should not have drafts in excess of 6.1m aft and 5.5m forward in order to avoid striking the bottom in a heavy swell. Warping buoys are moored off both sides of the pier.

The berthing facilities consist of a finger pier, 246m long and 25m wide, protected by a breakwater. On either side of the pier are berths for general cargo; each berth is 123m long and has a depth of 5m alongside.

**Pilotage.**—Pilotage is compulsory. Pilots are available 24 hours and board vessels about 0.5 mile N of the breakwater head.

**Anchorage.**—Anchorage can be taken, in a depth of 8m, mud, about 0.2 mile NNW of the breakwater head with the W spire of the twin-spired church bearing 168° and Isleta Jarro, close off Punta Salinas, bearing 263°. Smaller vessels can anchor closer in.

**2.31** The coast between Puerto Carupano and Morro de Chacopata, 33 miles W, is bordered by fringing rocks and dangers which lie within 1.5 miles of the coast. Islas Garrapatas forms the outermost danger.

**Morro Blanco** (10°41'N., 63°20'W.), a rocky promontory covered with dense growth, is located about 4.5 miles W of Puerto Carupano. Punta Padilla, 2 miles W of Morro Blanco, is not conspicuous, but it can be identified by a 46m islet with a round summit and a gray rock formation at its base that lies close off it. Small vessels with local knowledge can anchor in the small bay lying W of Morro Blanco.

Cerro San Jose, 1,030m high, stands 10 miles S of Morro Blanco and is a good landmark when not obscured by clouds.

**Punta de Tacquien** (10°41'N., 63°23'W.), 2.3 miles WNW of Punta Padilla, is salient and rises to a rounded hill covered with vegetation and ending in gray, rocky bluffs. Rocks extend up to 0.2 mile off the point and, being white, are visible from a considerable distance offshore.

**Ensenada Garrapatal** (10°39'N., 63°26'W.), a small bay with shallow depths and a village standing on its E side, lies 1.5 miles SW of Punta de Tacquien.

**Islas Garrapatas** (10°41'N., 63°28'W.), three rocks up to 7m high, lie near the outer end of a foul area that extends about 1.5 miles from the main coast at Morro de Lebranche (10°41'N., 63°28'W.). Vessels should not attempt to pass inshore of the rocks as breakers have been reported to occur between them and the coast.

**2.32 Ensenada La Esmeralda** (10°39'N., 63°30'W.) is entered 4 miles SW of Islas Garrapatas. Punta Esmeralda, together with Isla Esmeralda close off it, form the E side of the bay. Isletas Cascabel, three islets and some adjacent rocks, foul the E side of the bay.

Anchorage can be taken, in a depth of 11m, mud, about 1 mile N of the village of Saucedo, with the tangent of the NW side of Isla Esmeralda bearing 060° and the W islet of the Isletas Cascabel group bearing 103°. This latter islet is bare and white.

Vessels approaching Ensenada La Esmeralda should give Islas Garrapatas and Isla Esmeralda a berth of at least 0.5 mile.



The coast between Ensenada La Esmeralda and **Punta Guarapotura** (10°39'N., 63°42'W.), a bold and rocky headland 13 miles W, consists of red cliffs, 12 to 45m high, broken by occasional sandy beaches. Punta Manzanillo (10°38'N., 63°35'W.) and Punta Gorda, 1.5 miles W, are difficult to identify.

Between Punta Guarapotura and Escudo Blanco, 2.5 miles W, there are cliffs up to 18m high, which are white and distinctive in places.

**Morro de Chacopata** (10°42'N., 63°49'W.) stands on the N extremity of a headland from which a light is shown, about 4.5 miles NW of Escudo Blanco. The headland is bold, rocky, 50m high, and reddish in color. The coast between Morro de Chacopata and Escudo Blanco is low and backed by a sandy plain.

**2.33** Bahia Chacopata is a bay lying close W and SW of Morro de Chacopata and is shoal. It should only be used by vessels of shallow draft with local knowledge. The islands Isla Caribe and Islote Lobos lie within 3.8 miles WSW of Morro de Chacopata.

Anchorage can be taken, in depths of 9 to 11m, about 0.8 mile SE of Islote Lobos.

Islotes la Tuna, the only off-lying dangers located off the N coast of Peninsula de Araya, lie about 9.3 miles WSW of Morro de Chacopata. These islets are low and bare, the middle and highest being white and the other two being brown.

The current off the N side of the peninsula generally sets W, with a rate seldom exceeding 0.5 knot.

**Punta Tuna** (10°38'N., 63°57'W.) lies on the N shore of Peninsula de Araya, about 2.5 miles SE of the southernmost islet of Islotes la Tuna. Punta Morros de la Pena, a rocky headland, lies about 6 miles W of Punta Tuna. Between the headland and Punta Gorda, 2.5 miles WSW, the coast is rocky.

Ensenada Salinas, with a sandy beach, is entered between Punta Gorda and Punta Guachin, a low and rocky bluff 5 miles W. Between Ensenada Salinas and Punta Escarceo, 8 miles W, the coast is low, rising gradually toward that point.

## Isla de Margarita

**2.34 Isla de Margarita** (11°00'N., 64°00'W.) is the largest of a group of islands, known as Nueva Esparata, lying within an area extending 35 miles from the coast. The other islands of the group are Isla Coche, Isla Cubagua, and Los Frailes.

Isla de Margarita consists of two rocky mountainous sections joined together by a low sandy isthmus, about 2.5 miles wide. When seen from a short distance N or S, the island appears as two separate islands. Picos de Maria Guevara are two hills standing in the middle of the S side of the isthmus. They are prominent when viewed from the N or S.

The E and largest part of Isla de Margarita rises to Cerro San Juan, a peak 988m high, near the E end of Cerros de la Vega de Margarita, a mountain range. This part of the island contains several summits with valleys in between them. La Asuncion, the capital, stands on the NE side of the mountain range.

The W part of Isla de Margarita consists of Cerros del Macanao, another mountain range with four peaks. The highest summit rises to a height of 1,160m. These peaks make excellent landmarks. This part of the island is scantily populated, whereas the E part is heavily populated.



Isla de Margarita Light

**2.35 Cabo de La Isla** (Cabo Negro) (11°10'N., 63°53'W.), the N extremity of Isla de Margarita, marked by a light, has a small islet lying close NE of it. A shoal, with a least depth of 9.4m, lies about 7.5 miles NW of the cape.

Punta Galera, a high point, forms the N extremity of Cerro Galera and stands about 6.8 miles SW of Cabo de La Isla. Isla Galera, a small islet, lies 1.3 miles NNE of this point.

**Bahia de San Juangriego** (11°05'N., 64°00'W.), a small bay fringed by shoals which extend up to 1 mile offshore, lies between Punta Galera and Punta Maria Libre, 3.3 miles SW. The town of Juangriego stands at the head of the bay. A prominent red church, with twin spires, stands in the town and a prominent white monument is situated 1 mile S of Punta Galera.

Sheltered anchorage can be taken, in a depth of 11m, in the lee of Cerro Galera with the monument bearing 105°, distant 1 mile.

**Caution.**—Care should be taken to avoid a rocky shoal, with a least depth of 3.6m, lying near the middle of Bahia de San Juangriego, 1 mile W of the church.

**2.36 Bahia Norte** (Ensenada La Guardia) (11°02'N., 64°05'W.) indents the coast between Punta Maria Libre and Punta de Tigre (Punta Tunar), marked by a light, 11 miles WNW. Depths shoal from 27m in the entrance to 11m and less near the head.

The village of La Guardia, with a prominent church, stands along the SE shore. The head of the bay is low and swampy.

The coast between Punta de Tigre and Morro del Robledar, 11.5 miles W, is clear and free of off-lying dangers. A large shoal, with depths of 18m and less, lies between Morro del Robledar and Punta Arenas, 4.5 miles S, and extends 10 miles NW from the coast. Bajio Ostial, a detached patch, has a least depth of 8.3m, and lies within this shoal, about 5.5 miles NW of Punta Arenas. A 12.2m shoal patch lies 2 miles WNW of Bajio Ostial.

Vessels are advised to pass to the W of Bajio Ostial due to the shallow patches reported to lie E of Bajio Ostial. Staying 10 miles seaward of Morra del Robledar will clear the above-mentioned dangers.

From Cabo de La Isla, the E coast of Isla de Margarita extends 4 miles S to Cabo Blanco, a defined light gray rocky point. Isletas del Cabo lie within 1.3 miles SE of Cabo de La Isla. Two above-water rocks lie off Cabo Blanco. Puerto Fernin, a small village, stands 0.5 mile SW of Cabo Blanco.

The coast between Cabo Blanco and Punta de la Ballena, 8.5 miles SSE, consists of an unbroken sandy beach. Punta de la Ballena is a rocky headland marked by a light, 70m high, connected to the shore by a sandy pit. A 12.2m shoal patch lies about 0.4 mile SE of Punta de la Ballena.

Cerro del Balantia, 657m high, stands 4.8 miles S of Cabo Blanco.

**2.37 Bahia Pampatar** (10°59'N., 63°50'W.), fringed by a sandy beach, is entered between Punta de la Ballena and Morro de Puerto Moreno, 3.8 miles WSW. Depths within the bay are 5.5m and less within 0.3 mile off the shore in places. Otherwise, the bay is clear of dangers. Isla Blanco, 30m high and prominent, lies 2 miles SSW of Punta de la Ballena. This islet has a white top and a dark base.

A fort, with two towers, stands on the shore and is a good landmark. The cathedral, with a square tower, and the customhouse, a prominent gray building, stand close NW of the fort.

**Pampatar** (10°59'N., 63°48'W.) is situated in the NW part of the bay. The port has a small pier used for landing cargo. This pier was reported (1991) to be dilapidated.

**Pilotage.**—Pilots embark seaward of a line joining Punta de la Ballena and Morro de Puerto Moreno.

**Anchorage.**—Good anchorage can be taken, in a depth of 7m, about 1 mile WSW of Punta de la Ballena. Cargo is usually worked into barges at this anchorage.

Puerto Moreno, a shallow bay with a sandy beach at its head, lies between Morro de Puerto Moreno and a point about 2 miles NNE.

**Caution.**—It was reported (1994) that large concentrations of fishing boats and their gear may be encountered between Punta de la Ballena and Punta Mosquito.

**2.38 Bahia La Mar** (10°55'N., 63°50'W.) indents the coast between Morro de Puerto Moreno and Punta Mosquito, 5 miles SW. The head of the bay is foul up to 0.3 mile offshore, with depths of less than 9m.

Punta Mosquito, marked by a light, is barren and reddish-brown in color. This point appears as an island from a distance because of the low land behind it.

Anchorage can be taken, in a depth of 9m, with the church in the town bearing 000° and the S extremity of Morro de Puerto Moreno bearing 061°.

**Porlamar** (10°57'N., 63°51'W.), the principal town of Isla de Margarita, is situated on the N side of the bay. The church in the town and the two radio masts on the shore are good landmarks.

Two piers, with shallow depths alongside, extend from the shore abreast the town. Cargo is discharged into barges at the anchorage.

**2.39 Punta Carnero** (10°53'N., 64°01'W.) is reported to be a tank farm complex. A finger pier fronts the tank farm and extends 0.5 mile offshore. Small tankers and gas carriers can berth alongside its head.

The tank farm also provides a sea berth for larger tankers, about 0.5 mile SSW of the pier head. This sea berth, which is illuminated at night, consists of mooring and breasting dolphins connected by catwalks. A prohibited anchorage area lies between the tank farm sea berth and Punta Carnero, as best seen on the chart.

From Punta Mosquito, the coast extends 10 miles W to Punta Mangle, a low sandy point. The dense, green mangroves on this latter point help to identify it. Laguna Marites discharges along this section of the coast, about 3 miles W of Punta Mosquito.

**Bahia Guamache** (10°53'N., 64°05'W.) is entered between Punta Mangle and Punta de Piedras, 3 miles NW. It is bordered by shoal ground which extends up to 1 mile off the N shore. The village of Tubores stands close E of Punta de Piedras. Anchorage can be taken about 1 mile S of this village, in a depth of 9m, clear of the charted ferry routes. A prominent radio mast stands 1.3 miles E of Punta de Piedras.

**Caution.**—A dangerous wreck is reported to lie in position 10°53'07"N, 64°07'06"W.

**2.40 Puerto El Guamache** (10°52'N., 64°04'W.) (World Port Index No. 12230), situated on the S coast of Isla de Margarita, is in an open roadstead, with one berth for general cargo. The port has an ambitious development plan scheduled to be implemented over the next several years.

**Depths—Limitations.**—For vessels bound for the cargo pier, the maximum dimensions are 122m in length and 10.1m draft.

Vessels up to 35,000 dwt, with a maximum draft of 10.8m, can be accommodated at the oil terminal. There is one berth, 126m long, with an alongside depth of 11m. Mooring and breasting dolphins on each side connected by catwalks.

**Pilotage.**—Pilotage is compulsory. Pilot embarks on arrival or at the anchorage. An ETA message should be sent 72 hours, 48 hours, and 24 hours in advance through call signs ITT or YVG. Vessels will maintain their engines on standby at the anchorage. The port office is equipped with VHF channel 16.

**Anchorage.**—Anchorage is available on the W side of Punta Mangle at Bahia Guamache, in depths of 14 to 20m.

**2.41 Bahia de Mangle** (10°56'N., 64°10'W.) is entered between Punta de Piedras and Punta Manzanillo, 6.5 miles WNW. It is bordered by shoals which extend up to 1 mile offshore. Laguna Grande discharges into the N part of this bay. The shores of the bay are low and covered by mangroves. The village of Boca del Rio stands on the N side of the bay, on the W side of the entrance to the lagoon.

A rock, with a depth of 2m or less, whose position is approximate, lies near the head of Bahia de Mangle in the approaches to Boca del Rio. A spit, with a least depth of 9.1m, extends about 1.8 miles S from Punta Manzanillo.

From Punta Manzanillo, the coast extends about 12 miles W to Puntas Arenas. The village of El Manglillo stands close E of Punta Negra, 5 miles W of Punta Manzanillo.

Between Punta Manzanillo and Punta Negra, the coast is bordered by a bank, with depths of less than 5.5m, which extends up to 1 mile offshore. Between Punta Negra and Punta Arenas, this bank is about 0.5 mile wide and is steep-to.

A dangerous wreck lies in the middle of Bahía de Mangle.

**2.42 Canal de Margarita** (10°50'N., 64°00'W.) lies between Isla de Margarita and the mainland. It has a least depth of 16.5m in mid-channel. Large vessels can use the fairway leading between Isla de Margarita, on the N side, and Isla Coche and Isla Cubagua, on the S. The passage lying between these latter two islands and the mainland is occasionally used by coasters, but it is not recommended by those without local knowledge. The N fairway is marked by lighted buoys.

**Directions.**—From a position 2 miles S of Punta Mosquito, steer 268° for about 10.5 miles to a position about 0.7 mile S of the lighted buoy moored 0.5 mile SSW of Punta Mangle. From this position, steer 285° for 5.3 miles until the light on the N end of the spit extending from the E end of Isla Cubagua bears 180°. Then steer 270° for 2.3 miles until the light on Punta Palanqueta bears 180°, distant 2 miles. A W course will then lead into deep water clear of all dangers. The above tracks lead through Canal de Margarita and over a least depth of 22m.

**2.43 Isla Coche** (10°46'N., 63°56'W.) is bare and mesa-shaped, with 61m high cliffs. Shoals, with depths of less than 9m, extend SE from Isla Coche to the mainland. A shoal, with depths of less than 1.8m, extends about 1.3 miles N from a low spit that forms the NW extremity of Isla Coche. Islets La Tuna, Isla Los Lobos, and Isla Caribe stand in the fairway between Isla Coche and the mainland.

Anchorage can be taken outside the reefs which border Isla Coche, but the best berth lies off the SW extremity, in a depth of 12m.

**2.44 Isla Cubagua** (10°49'N., 64°11'W.), bare and flat-topped, with 24m high bluffs, lies 8.5 miles W of Isla Coche. Shoals, with depths of less than 9m, extend up to 1.8 miles E from the E extremity and up to 1.8 miles S from the island. Lights are displayed from Punta Brasil and Punta Charagato on the N coast of the island.

**Caution.**—It is advised to use extreme caution when navigating this area, as many uncharted dangers may exist.

## Coast of Venezuela—Punta Escarceo to Puerto Sucre

**2.45** The coast of Venezuela from Punta Escarceo extends about 2.8 miles SW to Punta Araya and is low and sandy. There are some scattered huts in the vicinity of the latter point. The SW extremity of Punta Araya is known as Punta Chica.

**Bajo de Araya** (10°39'N., 64°18'W.), a shoal with depths of 1.2 to 5.5m, extends about 2.3 miles WNW from the coast between Punta Escarceo and Punta Araya. The sea breaks over the shallow heads on this shoal bank with strong winds, and it should be given a wide berth. This bank is fairly steep-to and soundings cannot be relied on to give warning of its proximity. The bank is marked on its NW extremity by a lighted buoy.

The stretch of coast between Morro de Chacopata to the E and Punta Araya to the W is known as Peninsula de Araya.

This peninsula separates Canal de Margarita to the N from Golfo de Carioco to the S. The peninsula is hilly in its E part, but low in its W part.

**Araya** (10°34'N., 64°17'W.), a town about 4 miles SSE of Punta Araya, is the site of a saltworks. Punta Piedras, 2.8 miles NNW of the town, is bold. A pier, 122m long, extends from the shore abreast the town and has a depth of 7.3m alongside its outer end. A quay, 396m long, is situated at the saltworks and has a depth of 10m alongside.

**Pilotage.**—Pilotage is compulsory. Pilots board at Puerto Sucre. Berthing is carried out before 0900 due to high winds.

**2.46** From Araya to Punta Arena, 4.5 miles SSE, the coast is fronted by bluffs, 15 to 18m high. A light is situated about 3.5 miles S of Araya, on the coast near Punta Arena.

**Golfo de Cariaco** (10°30'N., 64°00'W.) is a large, narrow bay entered between Punta Arena and Punta Carenero, 3 miles SE. The general depths range from 18 to 73m, and except for the fringing shoals along the shores, the bay is clear of off-lying dangers.



**Punta Arena Light**

The N shore of the gulf is backed by steep mountains and lined with small towns and fishing hamlets.

Laguna Grande del Obispo, an irregular inlet on the N side of the bay, has depths of 25 to 36m in the entrance and 9.1 to 27m in the central basin. Both entrance points are fringed by extending reefs.

The S shore of the gulf is backed by several villages and farmland on a plain, from which rise the foothills of a mountain range. Many streams flow into the gulf along this shore.

**2.47 Cumana** (Puerto Sucre) (10°28'N., 64°11'W.) (World Port Index No. 12220), the port terminal for Cumana, is principally a fishing terminal, but is used by oil companies to land cargo and equipment for the oil fields inland.

Castillo San Antonio, a large rectangular building with a white foundation and yellowish-brown upper part, stands on a hill in the E part of Cumana and is conspicuous. A light-colored shed is situated on the head of the pier, a water tower stands at the root of the northernmost pier, and an aluminum tank is situated close E of Morro Colorado. All these land-

marks are conspicuous.

Puerto Sucre and Cumana are situated on a short plain through which the Rio Manzanares flows and enters the sea at Punta Carenero, 0.5 mile N of the port. Mountains back the plain 3 to 4 miles S and E of Cumana. Morro Colorado, with prominent red cliffs, rises close inland, 1.3 miles S of the port.

The main pier at Puerto Sucre projects SW from the coast for nearly 0.2 mile. A berth on the NW side of the outer end of the pier is for large vessels, up to 130m in length, and has depths of 7 to 13m alongside. The berth on the SE side is 160m long and has a depth of 6m alongside. Vessels secure heading NE. Maneuvering space abreast the inshore berth is restricted by the shore bank. There is a ro-ro berth at the head of the pier.

**Pilotage.**—Pilotage is compulsory and is available to assist in anchoring. Pilots usually board incoming vessels in the roadstead and are available 24 hours. Pilots can be contacted on VHF channel 16.

**Anchorage.**—Anchorage can be taken, in a depth of 27m, about 1 mile SW of the pier head. This anchorage should be approached by heading for Morro Colorado on course of 147°. The holding ground is good, over a bottom of sand and mud.

## Puerto Sucre to Puerto La Cruz

**2.48** On the coast between Puerto Sucre and Bahía de Pertigalete, 26 miles SW, there are no ports of importance, although there are several fairly deep bays and inlets. Several fishing villages are situated along this section of coast.

From Puerto Sucre to Punta Piedras, 3.5 miles SW, the coast is low, sandy, and then cliffy in places to Barranca de Mochima, about 6 miles W.

**Cerro Escondido** (10°23'N., 64°17'W.), 183m high and conical, is the best landmark from seaward and stands 3 miles SE of Barranca de Mochima.

**Puerto Mochima** (10°24'N., 64°21'W.), an inlet, is entered W of Barranca de Mochima. It is one of the best harbors on this part of the coast, but it is narrow. The shores of the inlet are steep-to in many places, with the only off-lying dangers being close inshore or in some of the many creeks and coves. The village of Mochima stands at the head of the inlet, but has no commercial importance.

Anchorage can be taken 1.5 miles within the E side of the entrance, but the swinging room is restricted.

Punta Tigrillo, 2.5 miles WSW of the entrance to Puerto Mochima, rises to a dome-shaped hill, 61m high.

**Islas Caracas** (10°22'N., 64°25'W.), a group of four islands, lies in the N part of Ensenada Tigrillo, an irregular bay formed between Punta Tigrillo and Punta Gorda, 5 miles SW. These islands rise up to 183m high, are fairly steep-to, and are intersected by deep passages. Isla Picuda Grande, the W island of the group, has several rocks lying up to 0.5 mile off its N end and is 122m high.

**Bajío Caracas** (10°24'N., 64°27'W.), a dangerous unmarked shoal with depths of less than 1m, lies 1.5 miles NNE of the N extremity of Isla Caraca del Oeste. A detached 2m patch lies 0.3 mile NNE of the same point.

**2.49 Golfo de Santa Fe** (10°18'N., 64°26'W.) is entered between a point, located 1 mile S of Punta Gorda (10°20'N., 64°28'W.), and Punta del Escarpado Rojo, a red-cliffed point 3

miles SSE of Punta Gorda. The bay is generally clear of dangers and has depths of 36 to 73m. An above-water rock lies about 1 mile SSE of the N entrance point.

The N shore is barren except for cactus, whereas the S shore is wooded and cliffy in places. The fishing village of Santa Fe stands on the W bank of a river, about 2 miles E of the S entrance point.

**Bahía Cruz** (10°16'N., 64°27'W.), the bight between Punta del Escarpado Rojo and Punta Cruz, about 1 mile SSW, is clear of dangers up to 0.1 mile offshore, except for a shoal fringing the former point. Good anchorage is provided.

**Ensenada Harapos** (10°15'N., 64°29'W.), the bay between Punta Cruz and Punta Comona, about 4.5 miles W, is generally clear except for a shoal that extends about 0.4 mile offshore, 1.8 miles E of the latter point.

**Islas Harapos** (10°16'N., 64°29'W.), two narrow islets about 12m high, lie 0.8 mile W of Punta Cruz. A 7.5m shoal patch lies 0.3 mile ENE of the E extremity of the easternmost island. The passage leading between this patch and Punta Cruz is about 0.3 mile wide and has a depth of 51m.

Two above-water rocks lie 0.2 mile off the W end of the W island of Islas Harapos. Depths of less than 18m extend up to 0.4 mile W of this island. Foul ground, which joins the two islands, extends 0.2 mile S from an above-water rock lying between them.

Shoal patches, with depths of 0.9m and 2.3m, lie 0.2 mile S and about 0.3 mile WSW, respectively, of the W extremity of the easternmost island.

**Bahía de Comona** (10°15'N., 64°32'W.), deep and clear of dangers, is entered between Punta Comona and Punta Pertigalete, 0.8 mile W. A saddle-backed mountain, 1,030m high, rises 2.5 miles inland of this bay.

**Caution.**—Dangerous shoals lie 1.3 miles NE and 0.9 mile E of Punta Comona.

**2.50 Isla Picuda Chica** (10°18'N., 64°34'W.), marked by a light, lies in the approach to Bahía de Pertigalete, about 3.5 miles NNW of Punta Pertigalete, and can be identified by its reddish color. Isla Cachicamo lies 1 mile SE of this island and is small in extent. Isla Quirica, 32m high, lies 1 mile SW of Isla Picuda Chica and has a below-water rock located close NW of it.

Isla Chimana Chica, the E island of the Islas Chimana, which extends a little over 6 miles W, stands about 0.3 mile W of Isla Quirica. A dangerous rocky ledge, with some rocks awash, extends 0.5 mile NNE from Chimana Chica.

Isla Chimana Segunda, 114m high in its central part, lies close W of Chimana Chica. A dark rock lies on a ledge extending 0.2 mile W from the W end of this island. The passage lying W of this rock has a least depth of 12.8m over a least width of 0.3 mile; it is seldom used and then only by small vessels. A charted Danger Zone between Isla Chimana Segunda and Isla Chimana Chica should be avoided because of the shoals it encompasses.

**Isla Monos** (10°16'N., 64°33'W.), 191m high, lies close N of Punta Pertigalete. Isla Tiguitigue, a small islet, lies close N of Isla Monos. A detached 9.8m patch lies about 0.8 mile SW of the islet.

**Bahía de Pertigalete** (10°15'N., 64°34'W.) is the site of an oil-loading terminal and a cement-exporting facility. Islas de

Plata, three in number, lie in the W part of the bay on a shoal spit which extends about 0.8 mile E from the W shore. Other islets border the W end of the S shore.

**2.51 Pamatacual** (10°14'N., 64°34'W.) (World Port Index No. 12210) has an oil-loading pier which extends 213m NNE from the S shore of the bay.

**Depths—Limitations.**—The pier is 114m long and has a depth of 10m alongside. An oil pipeline lies parallel to this pier, about 135m to the W. Its seaward end is marked by a buoy. Vessels berth heading NE with both anchors out and the stern secured to mooring buoys. Tankers up to 244m in length and 15.2m draft can be accommodated.

A narrow buoyed channel lies on the W side of the bay and to the W of the shoal spit with the Islas de Plata located on it. This channel should not be used without local knowledge.

A large pier extends from the shore in the SE part of the bay about 0.5 mile SE of the E end of Islas de Plata. A cement-loading berth is situated N of the pier and has mooring buoys lying off each side. The berth is 158m long and has a depth of 11.9m alongside. It can accommodate vessels up to 150m in length. A T-head pier extends from the northernmost islet of those bordering the W end of the S shore of the bay.

**Aspect.**—A tower, 46m high, stands on a hill, with an elevation of 457m, about 2.5 miles SSW of Punta Pertigalete.

**Pilotage.**—A pilot must be embarked at Puerto La Cruz. Vessels are berthed during daylight hours only.

**Directions.**—A vessel entering the bay should do so on a SW course, keeping midway between the E entrance point and Islas de Plata. When entering from the W, Punta Guanta should be given a berth of at least 0.2 mile, and a vessel should pass about that distance E of the Islas de Plata.

**2.52 Guanta** (10°15'N., 64°35'W.) (World Port Index No. 12200) lies within Bahia Guanta and is the major general cargo facility for the E part of Venezuela. The bay provides a natural sheltered harbor with berthing facilities situated along the S shore.

**Winds—Weather.**—The winds are generally from the NE, but vessels are cautioned that S winds may be experienced from June to September. Within the harbor, swells do not affect cargo operations.

**Tides—Currents.**—Currents within the bay are negligible; the tidal rise is about 0.4m.

**Depths—Limitations.**—The entrance channel leads S between Isla Pitahaya, on the W side, and Round Island (Isla Redonda), on the E side, and is about 180m wide. Lights mark both entrance islands. Reefs and rocks lie on the W side of the entrance channel and extend about 0.2 mile S from Isla Pitahaya.

The E side of the channel between Round Island and Punta Queque, about 0.4 mile S, is fouled by a reef with some islets on it. Reefs encumber the SW part of the bay.

The E berth is 232m long and has a depth of 7.6m alongside; the W berth is 320m long and has a depth of 11.2m alongside; and the middle berth is 322m long and has a depth of 8.2m alongside.

Vessels normally berth port side-to at the W pier and starboard side-to at the E pier. The Customhouse, a large stone building, stands near this wharf and is prominent from sea-

ward.

A small pier is situated on the E side of Bahia Guanta and has a depth of 7.6m alongside.

**Pilotage.**—Pilotage is compulsory. Pilots embark at Puerto La Cruz, 1 mile offshore, but are available during daylight hours only. An ETA should be sent 48 hours and 24 hours in advance to “Meneven Puerto La Cruz” by VHF. Berthing is carried out during daylight only, but departure can be arranged for any time.

**Anchorage.**—Anchorage for Guanta is available in Bahia de Pozuelos. Vessels awaiting a pilot or berth may anchor, in depths of 14 to 24m, protected, within the bay. There are no size limitations for the anchorage.

**2.53 Isla Chimana Grande** (10°18'N., 64°40'W.) is the largest of a group of rocky islands extending a little over 12 miles W from the W extremity of Isla Cachicamo. Its coasts are precipitous, except at landslides on the N side and at sandy beaches at the heads of coves on the S side. Isla Chimana del Sur lies 0.3 mile S of the E extremity of Isla Chimana Grande. Its SW end is formed by a bold headland, 95m high, which terminates in Punta Bagean, the SW extremity.

**Isla Chimana del Oeste** (10°18'N., 64°41'W.) is joined to the NW end of Isla Chimana Grande by a shallow bank on the middle of which there is an islet.

Morro Pelotas is a dark-colored islet lying 0.1 mile NW of Isla Chimana del Oeste; a light is shown from the summit of the islet.

**Cayo Borracho** (10°18'N., 64°45'W.), located 2.5 miles W of Morro Pelotas, is rocky, precipitous, and almost without vegetation. The island, 376m high, is easily identified from seaward and can be seen at a great distance. A light with a racon is located at the summit of the island.

A W set, with a rate of 0.8 knot, has been reported (1994) to occur off the N end of the island.

Two islets lie on a shallow bank extending nearly 1 mile W from the NW side of Cayo Borracho.

A rock, with a depth of 2m or less, lies about 0.5 mile SW of the SW extremity of El Borracho (10°16'N., 64°45'W.).

Los Borrachitos, lying 1 mile SW of El Borracho, are steep-to on their SW sides.

## **Puerto La Cruz (10°14'N., 64°38'W.)**

World Port Index No. 12185

**2.54** The Puerto La Cruz area consists of the Los Cocos terminals, on the SE shore of Bahia de Pozuelos, and the Guaraguao and El Chaure terminals at Bahia Bergantin. These terminals form the outlet for the second most important petroleum center of Venezuela. The Los Cocos terminals are distribution centers for coastal needs. The Guaraguao and El Chaure terminals are operated by the Mene Grande Oil Company and the Sinclair Oil Company, respectively. The former company acts as agent for several large oil firms and manages the largest terminal which has general cargo berths in addition to berths for large tankers.

**Depths—Limitations.**—The main entrance channel leading into Bahia de Pozuelos leads S between Morro Pelotas and Cayo Borracho and must be used by all deep-draft vessels.

This channel is 2 miles wide, clear of all dangers, and has depths of 18.3 to 54.9m in the fairway. Depths in the roadstead within the bay range from 9.1 to 36.6m.

The entrance fairway into Bahia Bergantin leads E between Isla Burro (10°15'N., 64°38'W.) and the berthing facilities to the S. This channel is clear of dangers, except for a detached 8.7m patch on the S side of the fairway, about 0.3 mile SW of Isla Burro. Shoal depths extend about 115m S from Isla Burro, and depths of 9.1 to 11m extend almost 0.5 mile WNW from the W end of the Guaraguao cargo wharf. The reefs within Bahia Bergantin are clearly visible during the day time and are marked by aids. Vessels moor starboard side-to in Bahia Bergantin.

**Guaraguao** (10°14'N., 64°38'W.), situated in the SW part of Bahia Bergantin, consists of oil berths and the cargo berth of Puerto La Cruz.

Berth No. 1 to Berth No. 3, numbered from the W, extend along a wharf. Vessels up to 50,000 dwt and 11.5m draft can moor at these berths.

Berth No. 4 and Berth No. 5, situated close E of the wharf, are formed by a T-headed pier, with mooring dolphins spaced on each side of its head.

A wharf for general cargo is situated between Punta Guaraguao and the oil loading wharf. It is 207m long and has a depth of 7.6m alongside.

**El Chaure** (10°15'N., 64°37'W.), a terminal in the SE part of the bay, is considered to be Berth No. 6 of Puerto La Cruz. It consists of a wharf, 30m long, with mooring dolphins on each side. Vessels up to 60,000 dwt and 12.1m draft can be handled here. The use of tugs is mandatory.

A pier at Los Cocos (10°13'N., 64°39'W.) extends 168m from the shore at the SW end of Puerto La Cruz and serves as an oil terminal. Its outer end is 15m long, with a depth of 8m alongside. Two clusters of dolphins stand parallel to and on either side of the pier head.

Puerto La Cruz—Oil Berth Information			
Berth	Maximum Vessel		
	LOA	Draft	Size
No. 1	182m	11.5m	50,000 dwt
No. 1	228m	11.5m	50,000 dwt
No. 2	198m	11.5m	50,000 dwt
No. 2	228m	11.5m	50,000 dwt
No. 3	182m	11.5m	45,000 dwt
No. 3	213m	11.5m	45,000 dwt
No. 4	280m	16.7m	120,000 dwt
No. 5	280m	16.7m	120,000 dwt
No. 6	243m	12.1m	58,000 dwt
No. 7	289m	15.5m	120,000 dwt

A ferry pier, situated close E of the oil pier, extends 120m offshore and has depths up to 3.7m alongside.

**Aspect.**—The adjacent islands, which lie in the approaches, are all moderately-high and rocky with sparse vegetation. The

radio towers situated 4 miles SW and 3 miles S of the town of Puerto La Cruz are prominent. Cayo Borracho (10°18'N., 64°45'W.) and the lighthouse on the summit of Morro Pelotas, 2 miles E, may be easily identified. Within Bahia de Pozuelos, the cranes and control tower at the Guaranguao Terminal are prominent as well as the oil tanks standing about 0.8 mile NE of Puerto La Cruz.

**Pilotage.**—Pilotage is compulsory. An ETA should be given 72 hours, 48 hours, and 24 hours in advance to “Corpoven Puerto La Cruz” through Puerto La Guaira coast radio station. Pilots board in Bahia de Pozuelos approximately 1.5 miles E of Isla Burro.

**Anchorage.**—Anchorage can be taken, in depths of 14 to 22m, within Bahia de Pozuelos, W and WNW of Isla Burro. The anchorage areas may best be seen on the chart. An anchorage area also lies about 3.5 miles W of El Morro de Barcelona.

**Directions.**—The channels on each side of Isla Burro can be used, but the normal entrance for vessels with drafts less than 9.1m is through the S channel. The current is negligible, but wind strength in the afternoon and evening should be considered. The NE channel is used by vessels with drafts of 9.1m and greater. Such vessels should enter by steering a SSE course to pass midway between the charted aids.

### Puerto La Cruz to Cabo Codera

**2.55** The coast from Puerto La Cruz extends 3.2 miles WSW to a small spit located 0.5 mile W of the village of La Lecheria.

Bahia de Barcelona is entered between Morro de Barcelona and Punta Chacopata, 15 miles WSW. Between the low sandy shore of the bay and the foothills inland there are extensive salt flats.

**Morro de Barcelona** (10°13'N., 64°43'W.), located about 4 miles W of Puerto La Cruz, is rocky, 157m high, and heavily covered with cactus. Several radio towers stand near the coast between these points.

The town of Barcelona stands on the SW bank of the Rio Neveri, about 4.5 miles S of Morro de Barcelona.

The coast between Morro de Barcelona and the mouth of the Rio Uchire is bordered by depths of 11m and less which extend between 1 mile and 2.5 miles offshore in places. The W half of this section of coast is bordered by shallow lagoons fronted by narrow strips of sandy beach.

**2.56 Puerto Jose (Jose Terminal)** (10°06'N., 64°51'W.) (World Port Index No. 12180) is situated at the W end of Bahia de Barcelona. It is a terminal for loading refined petroleum products.

**Depths—Limitations.**—The approach channel is 150m wide, with a minimum depth of 13.6m.

An SPM buoy, connected to storage tanks on shore by a submarine pipeline, is situated 1.8 miles NNE of Fairway Lighted Buoy. For berthing information see the table titled **Puerto Jose (Jose Terminal)—Berth Information**.

**Aspect.**—Fairway Lighted Buoy is moored 1.2 miles NNE of the terminal.

**Pilotage.**—Pilotage is compulsory. The pilots and the terminal may be contacted on VHF channels 12 and 16. Pilots prefer docking during daylight hours only.

Pilots board about 1.5 miles N of the Petroterminal Jose platform.

**Regulations.**—An ETA should be sent 7 days, 72 hours, 48 hours, and 24 hours in advance. Contact with the terminal must be established at least 4 hours prior to arrival, confirming the ETA or providing any changes.

Maximum-sized vessels are only berthed during daylight hours and in wind speeds of less than Force 7.

**Anchorage.**—Anchorage may be obtained in the W part of Bahía de Pozuelos. The bay is well-sheltered with good holding ground, mud and sand bottom.

**Directions.**—A Vessel Traffic System has been established in the navigable waters between Bergantin Bay and Jose Terminal. The service will advise vessels of safety hazards, traffic recommendations, and environmental regulations in effect.

Vessels should approach the terminal from the NE on a bearing of 228°, leaving the SPM buoy and its outer mooring buoy to starboard.

**2.57 Islas Piritu** (10°10'N., 64°57'W.), two in number, are low and sandy. They lie 13 miles WSW of Morro de Barcelona. The narrow channel lying between the islands has a least depth of 9.1m, but should not be attempted without local knowledge.

A light is shown from the W extremity of the W island. The passage lying between these islands and the coast is about 1.3 miles wide at its narrowest part and is clear in mid-channel, except for an 8.5m shoal which lies about 1.3 miles S of the E extremity of the E island.

**Puerto Piritu** (10°04'N., 65°02'W.), a small fishing port available only to small craft, is situated on the coast about 7.5 miles SW of Islas Piritu.

**Cerro Unare** (10°05'N., 65°15'W.), 579m high, stands near the coast about 12.5 miles W of Puerto Piritu. From any distance, this prominent peak appears as an isolated promontory because of the low coast in the vicinity.

The coast between the Rio Uchire and the Rio Curiepe, about 45 miles NW, is generally low and swampy, but backed by high hills inland. Laguna de Tacarigua, a shallow lagoon, lies about midway along this stretch of coast. The small town of Rio Chico stands a few miles NW of the W end of this lagoon, and the town of Higuero is situated 12 miles farther

NW. A spit, with a depth of 4m at its outer end, extends about 1 mile NE from this latter town. A drying rock stands on this spit about 0.5 mile offshore.

Anchorage can be taken, in a depth of 10m, about 1 mile E of the town. During daylight hours, the spit and the rock are clearly visible.

**2.58 Puerto Carenero** (10°32'N., 66°07'W.), situated 4 miles NNW of Higuero, consists of a small town fronted by a shallow harbor. The berthing facilities are available only to small vessels of shallow draft.

Anchorage can be taken, in a depth of 9m, mud, about 0.4 mile SW of the E entrance point of the harbor.

**Cabo Codera** (10°35'N., 66°03'W.), a prominent steep-to headland, is 264m high and marked by a light.



Cabo Codera Light

**Farallon Centinela** (10°49'N., 66°05'W.) lies about 14 miles N of Cabo Codera and was previously described in paragraph 2.5.

Puerto Jose (Jose Terminal)—Berth Information			
Berth	Maximum Vessel		
	LOA	Draft	Size
Bitmar SBM	280m	28.0m	300,000 dwt
Petrozuata	—	11.5m	130,000 dwt
TAEJI East and West Berths	350m	25.0m	310,000 dwt
TAEJ South Berth	289m	22.0m	150,000 dwt
Cryogenic Pier Berth 8 & 9	270m	13.8m	45,000 dwt
Pequiven Fertinitro (East and West)	255m	14.0m	65,000 dwt
Sincor Multipurpose (East)	230m	12.4m	50,000 dwt
Petrozuata Pier (Petcoke/Sulphur) W	254m	12.2m	65,000 dwt



Farallon Centinela Light

**Cabo Codera to Puerto La Guaira**

**2.59** Between Cabo Codera and Puerto La Guaira, 52 miles W, the coast is generally bold, rocky, and marked by a few projecting salient points that are prominent. Rocks fringe this section of coast, but most lie close offshore. The outermost danger is a breaking rock which lies 1 mile E of Punta Masparro (10°39'N., 66°14'W.).

**Ensenada de Corsarios** (10°35'N., 66°04'W.), a small open bay entered close W of Cabo Codera, provides anchorage, in a depth of 12m, about 0.4 mile offshore, SW of Punta El Morro, the NW extremity of the cape. The W shore of the bay is fronted by foul ground.

**Bahia Chuspa** (10°37'N., 66°20'W.), an open bay foul around its shores, lies 16.5 miles W of Cabo Codera. The lights in the village of Chuspa, in the SE part of the bay, form a good landmark at night.

Banco Sabana, a detached shoal with a least depth of 6m, lies in the entrance to this bay, about 3.5 miles WNW of the village of Chuspa.

Anchorage can be taken 0.5 mile offshore in the vicinity of Punta Chuspa, the E entrance point to Bahia Chuspa, but the holding ground is only fair.

A light is located on the coast 2 miles W of the village of Caruao.

**Punta Naiguata** (10°37'N., 66°45'W.) is the first prominent point W of Bahia Chuspa. A village stands on high red bluffs within and somewhat E of the point. A coconut plantation situated near the point is prominent.

A light is shown 0.8 mile SW of Punta Naiguata; however, it is of low visibility and almost obscured by shore lights.

**Punta Caraballeda** (10°37'N., 66°51'W.) can be identified by a palm grove and a plantation with two chimneys. The E

chimney can be seen from up to 10 miles offshore. Cerro Naiguata, 2,765m high, stands 5.6 miles SSE of the point and is the most prominent peak along this coast.

**La Guaira (10°37'N., 66°56'W.)**

World Port Index No. 12150

**2.60** Puerto La Guaira, an artificial harbor protected by breakwaters, is the principal port of Venezuela and the seaport for Caracas, the capital of the country. The harbor is sheltered by a N breakwater, 0.8 mile long. There are depths of 12 to 19m at the entrance to the harbor. There are a total of 27 berths in the port. The main commercial quays have depths of 5.5 to 11m alongside.



Puerto La Guaira North Breakwater Light



La Guaira

**Winds—Weather.**—The prevailing winds are the NE trades, which blow with great regularity from February to June.



Calms and W winds frequently occur from July to October.

Usually, once or twice a year during the autumn months, Calderetas, which are hot, sharp blasts from the mountains, have sufficient force to be dangerous to vessels not secured in the harbor. These winds are not of long duration.

Although Puerto La Guaira lies S of the hurricane belt, the effects of these tropical storms are occasionally felt in the harbor. During the hurricane season, vessels should be prepared to get underway on short notice.

**Tides—Currents.**—The diurnal range at springs is about 0.3m. The currents in the offing set to the W and near the coast are weak, seldom exceeding a rate of 0.3 knot. An inshore countercurrent may be experienced during the prevalence of calms and variable winds, especially during the autumn months, and may attain a rate of 2.5 knots.



Puerto La Guaira (aerial view)

Heavy and dangerous seas are experienced from October to March and result from strong gales in the Atlantic Ocean or the Caribbean Sea. They take the form of heavy ground swells, and, in the most severe cases, of long rollers usually coming in groups of three or four at infrequent intervals. These rollers have enormous force and destructive power and can cause great damage. The rollers at times begin to show in depths of 12m in lines about 2 miles long, gradually rising as they approach the coast. It has been reported that at Puerto La Guaira, a heavy ground swell of a dangerous nature is almost always preceded by calms or variable winds. During the rollers, there is a considerable scend in the harbor.

**Depths—Limitations.**—In the roadstead outside the entrance, there are general depths of 12 to 36m, decreasing to depths of 11 to 14.6m between the breakwater heads. There are depths of 8 to 16.3m over the greater part of the harbor.

The berthing facilities are situated on the S side of the inner part of N breakwater and around the entire perimeter of the harbor. They are numbered in a clockwise direction. Port facilities at La Guaira have been expanded on the S side of the North (extended) Breakwater. Additional berths are provided alongside the East Pier and the West Pier, which project into the harbor. All of the berths have dredged depths of 10.7m alongside, with the exception of the berths situated in the E end of the harbor, where the depths may be less because of silting.

It was reported that shoal patches, with depths of 9.1m, exist alongside most of those piers. Also, as a result of construction along the S side of the North Breakwater, depths of less than 6.1m exist within 60m of the breakwater.

The old oil pier on the inner side of the West Breakwater is for the exclusive use of naval vessels. Within the harbor, there is a turning basin with a diameter of 402m. For berthing information refer to the **La Guaira—Berth Information** table.



La Guaira berthing locations

Vessels are required to use tugs for berthing and unberthing.

La Guaira—Berth Information			
Berth	Length	Depth alongside	Remarks
<b>Muelle Notre</b>			
No. 1	160m	12.0m	Containers and ro-ro
No. 2	176m	12.0m	General cargo
No. 3	176m	—	General cargo
No. 4	176m	12.0m	General cargo
No. 5	176m	12.0m	General cargo
No. 6	155m	11.0m	—
No. 7	155m	11.0m	—
No. 8	160m	11.0m	Grain
No. 9	150m	6.0m	Coastal trader
No. 10	161m	10.0m	Coastal trader
<b>Muelle Raymond</b>			
No. 11	161m	10.0m	Coastal trader
No. 12	136m	10.0m	Coastal trader
No. 13	136m	10.0m	Coastal trader
No. 14	115m	10.0m	Coastal trader
<b>Muelle Sur</b>			
No. 15	168m	10.0m	Coastal trader

La Guaira—Berth Information			
Berth	Length	Depth alongside	Remarks
No. 16	144m	10.0m	General cargo
No. 17	144m	10.0m	General cargo
No. 18	144m	10.0m	General cargo
No. 19	144m	10.0m	General cargo
No. 20	168m	10.0m	General cargo
Terminal Maritimo			
No. 21	160m	10.0m	Passenger terminal and ro-ro
No. 22	160m	10.0m	Passenger terminal
No. 23	171m	10.0m	Passenger terminal
No. 24	171m	10.0m	Passenger terminal
Other Piers			
No. 25	84m	10.0m	Fishing
No. 26	300m	—	Naval

**Aspect.**—A vessel approaching from the N will first sight the high mountains in the interior in the vicinity of Caracas. Pico Avila, 3.5 miles SSE of Puerto La Guaira, has a distinctive tip at its summit.

A cylindrical building standing close E of Pico Avila is conspicuous from seaward. At night, the obstruction lights on this building are a good mark.

On closer approach, several landmarks are readily identifiable and are positioned from the root of the N breakwater, as follows:

1. A grain elevator close E
2. Three stacks, the E of which is situated 0.3 mile E
3. A long stone building of fortress-type construction situated about 0.3 mile SSE.

There are numerous other prominent buildings in the city. At night, the lights of cars descending down the mountain behind the city can be seen from a considerable distance to seaward.

**Pilotage.**—Pilotage is compulsory and available from 0600 to 2400 local time. Pilots board about 1 mile NW of the head of North mole, W of the main anchorage. An ETA must be sent 72 hours, 48 hours, and 24 hours before arrival. Changes of 6 hours in ETA should be promptly reported.

The pilots can be contacted, as follows:

1. Call sign: La Guaira (YXS2)
2. VHF: VHF channels 12 and 16
3. Telephone: 580-212-351-4911
4. E-mail: [op\\_portuarias@picsa.gov.ve](mailto:op_portuarias@picsa.gov.ve)

**Signals.**—A signal station is situated at El Vigia (10°36'N., 66°56'W.) and communicates with vessels by the International Code of Signals.

**Anchorage.**—The anchorage area off Puerto La Guaira is centered 1.5 miles NE of the head of North Mole. The area is best seen on the chart. It is exposed from the W through N to E, but is generally considered safe except in winter, the season of rollers. The anchorages should be used only temporarily.

Vessels carrying dangerous cargoes should anchor in a restricted area centered about 1.25 miles at the NNW Punta Mulatos. Quarantine anchorage lies E of the main anchorage, centered about 2 miles NNW of Punta Mulatos.

**Caution.**—Due to submarine cables, which may best be seen on the chart, anchoring and fishing are prohibited in an area, about 0.5 mile wide, extending 2.5 miles NNE of Punta Mulatos.

Numerous fishing boats may be encountered in the approaches to La Guaira. Many are not lighted and only display their lights upon the approach of another vessel.

## Puerto La Guaira to Puerto Cabello

**2.61 Cabo Blanco** (10°37'N., 66°59'W.), located 2.5 miles W of Puerto La Guaira, is rocky, bold, and prominent. Several radio towers stand on this cape. The cape has been reported to be a poor radar target.

Punta Calera, located 2 miles W of Cabo Blanco, is flat, relatively low, and can be identified by a cane plantation situated close inshore of it.

**Catia La Mar** (10°36'N., 67°02'W.) (World Port Index No. 12145), a village, is situated 1.3 miles SW of Punta Calera and has a T-head jetty extending 300m from the shore. The head of this jetty has a depth of about 7m alongside. A conspicuous house stands E of the jetty and a flat tableland rises behind the village. A tank farm stands SW of the root of the breakwater and four cement silos stand near the root of the jetty.



Catia La Mar

Three offshore oil berths, marked by mooring buoys, lie about 0.7 mile W and SW of the jetty.

Anchorage should be taken, in depths of 12 to 18m, N of the outermost buoy. Vessels wishing to enter Catia La Mar should either anchor or wait N of 10°36'50"N. Two prohibited anchorage areas have been established (2010), centered 2 miles ENE and 0.5 mile NW of Punta Arrecife.

**2.62** From Catia La Mar to Puerto La Cruz, 18.5 miles W, the coastal range stands farther inland and is not as high as the terrain to the E. A conspicuous power station stands near the coast about 6.8 miles W of Catia La Mar. This power station is served by an offshore oil terminal marked by five lighted buoys.

**Puerto La Cruz** (10°33'N., 67°21'W.), a small cove with moderate depths, indents the coast only a short distance and

has no commercial value. This port should not be confused with the port of the same name which lies 165 miles E of Puerto La Guaira.

**Morro Choroni** (10°31'N., 67°36'W.) is a rounded headland which can readily be distinguished from up to 10 miles offshore. It appears detached from the lower land in the vicinity and rises to an elevation of 76m. La Mesa, a flat-topped peak, rises to an elevation of 2,240m, about 9.3 miles SSE of the point.

**Puerto de Ocumare** (10°29'N., 67°46'W.), a small cove, has a depth of 14.6m in the entrance decreasing to 7.3m about 0.3 mile from its head. Pico Cucharonal, a prominent peak, is 1,850m high and stands 9.8 miles SSW of the port.

**Puerto Turiamo** (10°27'N., 67°51'W.) is entered between Punta Turiamo and Punta Cambiador, about 1.3 miles W, and extends 2 miles S to its head.

**Caution.**—Due to a naval base, the area around Isla Turiamo is restricted and closed to general navigation. The Restricted Area is best seen on the chart.

**2.63** The coast from Puerto Turiamo to Puerto Cabello is rocky and bluffy to Punta El Penon, and then low and sandy to Punta Brava (10°30'N., 68°01'W.). Roca Lavendera (10°29'N., 67°54'W.), a dangerous rock, lies 0.2 mile NE of Punta Yapascua.

Five islands lie within 1.3 miles of the coast between Punta El Penon and Punta Brava; they are Isla Larga, Isla Santo Domingo, Isla Alcatraz, Isla Raton, and Isla del Rey. All are of sand and coral formation covered by scrub and grass.

With the exception of Isla Raton, safe channels, with a least depth of 14.6m, exist in the passages between these islands.

**Isla Larga** (10°29'N., 67°57'W.), the E and largest island, lies 1 mile NW of Punta El Penon.

Good anchorage can be taken between this island and the mainland, in depths of 18 to 22m, sand and mud, with the W extremity of the island bearing 339°, distant 0.5 to 0.8 mile. Charted shoals and reefs encumber the SW approach to the island.

**Isla Alcatraz** (10°30'N., 67°58'W.), the next largest island and the N, lies 1.3 miles NW of Isla Larga. A large part of this island is occupied by a lagoon with its entrance at the NW end. A light and racon mark the SE entrance to the lagoon.



Isla Alcatraz Light

A shoal, with a depth of 13m, lies 1 mile E of Isla Larga. Another 13m shoal lies 0.5 mile S of Isla Alcatraz. A dangerous wreck lies 3 miles NW of Isla Alcatraz.

**Caution.**—Submarine cables, best seen on the chart, extend E and NE from the coast SE of Isla Raton. A ODAS buoy has been reported (2009) to be positioned about 1 mile W of Isla Alcatraz.

**2.64 Puerto Borburata** (10°29'N., 67°59'W.) (World Port Index No. 12130), a small cove, lies 1.5 miles E of Punta Brava and is the site of an oil terminal. There are depths of 9.1 to 14.6m in the fairway leading to the terminal over a width of 135m.

The berthing facilities consist of a dolphin berth and a wharf. A lighted range, in line bearing 140°, leads in to the harbor. The berth can accommodate tankers up to 180m in length and 9.4m draft. The small wharf can accommodate tankers up to 122m in length and 6.1m draft. It was reported (1987) that the wharf was not in use. Vessels intending to use these facilities should obtain a pilot and clearance at Puerto Cabello. Pilotage is compulsory, but vessels must anchor 1 mile N of Punta Brava to await instructions from the port authority.

### Puerto Cabello (10°29'N., 68°00'W.)

World Port Index No. 12120

**2.65** Puerto Cabello, the third ranking port of importance in Venezuela, provides facilities for the handling of general cargo, containers, bulk cargo, and chemicals. It consists of an artificially-improved lagoon, with the commercial facilities in its outer part and a repair yard in its inner part.

Due to many changes reported in the hydrography of the harbor, local knowledge is essential for entering.

Ample alongside berthing facilities are available for all classes of vessels.

**Depths—Limitations.**—In the approach to the harbor, the depths shoal gradually from 36m, about 3 miles NW of Punta Brava, to 16.5m off the harbor entrance.

Bajo Larne, with a depth of 5.9m, lies 0.3 mile NE of Isla Goaigoaza W of the harbor entrance. This shoal breaks when any sea is raised. Discolored water has been reported to occur about 0.3 mile NW of Punta Brava.

A dangerous wreck lies about 2.5 miles NNE of the light shown on Islas Goaigoaza.

A tanker wharf called Venterminales S.A. extends about 645m NE from shore about 0.4 mile SE of Islas Goaigoaza.

The 100m wide entrance channel, which leads W to E, has a dredged depth of 9.1m. There are depths of 7 to 12.8m in the harbor.

Vessels up to 35,000 grt, 230m in length, and 10m draft can enter the port.

A concrete marginal wharf, 1,025m long, provides eight berths for vessels with drafts up to 10m and forms the N side of the outer harbor. A swinging basin, 0.3 mile wide, lies N of the E end of this wharf. There is another basin lying NE of the swinging basin with two piers at its head and a wharf on its W side.

A channel, at the E end of the concrete wharf, leads 0.2 mile S into a basin, which is dredged to a depth of 8.7m. The W side



**Puerto Cabello**

of the channel (E pier) and the N side of the basin (S pier) are quayed, but depths are sufficient only for small vessels.

From the SE corner of the swinging basin, a channel, 137m wide, leads to a dockyard. It is dredged to a depth of 11m. On the SW side of this channel is a bulk cargo wharf, 405m long, which can accommodate vessels with drafts up to 10.6m.

Puerto Cabello—Berth Information			
Berth	Length	Depth	Remarks
No. 1	137m	10.6m	Passengers
No. 2	137m	10.6m	Passengers
No. 3	150m	10.6m	Passengers
No. 4	150m	9.4m	General cargo and ro-ro
No. 5	150m	9.4m	General cargo and ro-ro
No. 6	150m	9.4m	General cargo and ro-ro
No. 7	150m	9.4m	General cargo and ro-ro
No. 8	173m	9.7m	General cargo and ro-ro
No. 9	173m	9.7m	General cargo and ro-ro
No. 10	210m	10.0m	General cargo and ro-ro

Puerto Cabello—Berth Information			
Berth	Length	Depth	Remarks
No. 11	210m	10.0m	General cargo and ro-ro
No. 12	260m	9.7m	General cargo and ro-ro
No. 13	140m	9.4m	Coastal trade
No. 22	185m	11.2m	Containers
No. 23	185m	11.2m	Containers
No. 24	185m	11.2m	Containers
No. 24A	302m	11.5m	Containers
No. 25	204m	11.5m	Containers
No. 26	204m	11.5m	Containers
No. 27	206m	12.1m	Containers
No. 28	200m	10.6m	Bulk cargo
No. 29	200m	12.1m	Bulk cargo
No. 30	200m	12.1m	Bulk cargo
No. 31	203m	12.8m	Bulk cargo
No. 32	203m	12.8m	Bulk cargo
No. 37/38	200m	10.8m	Liquid chemicals
No. 39	180m	10.0m	Containers and general cargo

Puerto Cabello—Berth Information			
Berth	Length	Depth	Remarks
No. 40	180m	10.0m	Containers and general cargo
No. 41	180m	10.0m	Containers and general cargo
No. 42	180m	10.0m	Venezuelan navy

A submarine pipeline for discharging petroleum products extends about 0.3 mile N from the shore near a control station, a little over 0.4 mile SW of the entrance to Puerto Cabello. A buoy, moored close N of the seaward end of the pipeline, marks the position for letting go the port anchor. Tankers up to 40,000 dwt, 198m in length, and 10.4m draft can be handled at this berth. A ro-ro berth is also available.

**Aspect.**—The first landmark to be sighted will be Fortin Solano, a fort-like structure situated on a high hill, about 1.3 miles SSW of the harbor entrance. This structure can be seen from a distance of 20 miles on a clear day. A light is found close WNW of the fort. On closer approach, the lighthouse on Punta Brava will be seen.

Several oil tanks and a water tower, with a power plant standing in their vicinity, are situated 1.8 miles W of the harbor entrance.

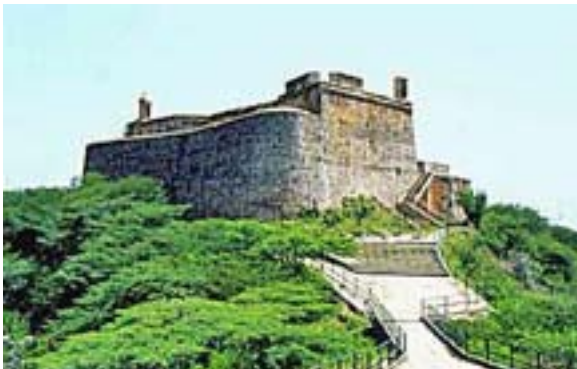

**Fortin Solano**



**Punta Bravo Light**

**Pilotage.**—Pilotage is compulsory for merchant vessels and highly recommended for all other vessels. Pilots board 0.5 to 0.8 mile off Punta Bravo Light. Pilots can be contacted on VHF channels 12, and 16.

Vessels waiting for a pilot should do so in the area lying between 10°31'N and the coast, and between 68°00'W and 68°02'W, excluding the entrance channel. Vessels may either anchor or remain underway, but stopped. Pilots will board in the order of arrival.

**Anchorage.**—The bay lying W of Puerto Cabello, between Punta Brava and Bajo Larne, provides anchorage, in depths of 11 to 20m, sand and mud. Vessels should anchor clear of the entrance channel. Anchorage areas designated Alpha, Bravo, and Charlie are best seen on the chart. A quarantine anchorage is located close E of Isla Goagoaza.

### Puerto Cabello to Puerto Chichiriviche

**2.66 Golfo Triste** (10°40'N., 68°13'W.), a large open body of water with fairly regular depths, lies between Punta Brava and Punta Tucacas, 25 miles NNW. Several off-lying cays and shoals in the NW part of the gulf lie within 5 miles offshore and can be considered dangers. Between Cayo del Sur and Cayo del Medio and close NE of the latter, are depths of less than 5.5m. Depths of 3.7 to 7.3m lie up to 0.5 mile NNE of Cayo del Norte. Except for these cays and the shoal depths in the vicinity of Punta Tucacas, the gulf is free of dangers. The bottom is sand and mud, and shoals gradually and uniformly toward the shore.

The prevailing currents set W and are forced out to the N by the cays and the coast in the vicinity of Punta Tucacas. An E current with eddies has been observed in the S part of the gulf.

The coastal range descends to a plain W of El Palito and the low coast is fronted by a sandy beach on which the surf is almost continuous. Several rivers discharge discolored water into the gulf, which may extend up to 3 miles offshore and give the appearance of shoals.

**2.67 El Palito** (10°30'N., 68°07'W.) (World Port Index No. 12115), an oil terminal, stands on Punta Chavez, about 6.8 miles W of Punta Brava.

**Tides—Currents.**—Heavy swells may be encountered and vessels should be prepared to get underway at a moments notice. During January through March, heavy sea and swell conditions may delay berthing. The currents usually set W at a rate of 1 knot in the vicinity of the pier. The normal range of the tide is about 0.3m.

**Depths—Limitations.**—The terminal consists of two piers extending from Punta Chavez. A total of 825m of pier space is available at the E pier; there is 1,451m of pier space available at the W pier. A total of four berths are available. The E pier contains Berth No. 1 and Berth No. 2. The W pier contains Berth No. 3 and Berth No. 4.

Berth No. 1 can accommodate vessels of 228m length, 12.2m draft, and 50,000 dwt.

Berth No. 2 can accommodate vessels of 210m length, 11.6m draft, and 50,000 dwt.

Berth No. 3 and Berth No. 4 can accommodate vessels up to 250m in length. Berth No.3 has an alongside depth of 14.6m, Berth No.4 has an alongside depth is 12.2m. Both piers can ac-

commodate vessels up to 85,000 dwt.

A refinery stands close S of Punta Chavez.

**Aspect.**—Lights are shown from towers, 24m high, standing on the NW and SE sides of the E pier head.

Three chimneys, each showing a flashing high intensity light, are situated at the refinery. A prominent flare is also situated at the refinery. When approaching the terminal at night, the navigational aids are often obscured by numerous background lights.

The chimney lights and the flare are reported to be visible from about 20 miles to seaward. A group of five tanks stands about 1.2 miles SSE of the E pier head. They are reported to be painted white and visible from 20 miles seaward on a clear day.

Three conspicuous chimneys, painted in red and white bands, stand 2 miles W of the terminal near Punta Moron.

**Pilotage.**—Pilotage is compulsory. Pilots board at the anchorage and are available any time, day or night.

The pilots can be contacted, as follows:

1. Call sign: El Palito Terminal
2. VHF: VHF channels 6 and 16
3. Telephone: 58-242-360-4136  
58-242-360-4130
4. Facsimile: 58-242-360-4248

**Regulations.**—An ETA should be sent at least 72 hours prior to arrival. The message should include the estimated time to discharge ballast. This ETA should also be confirmed 24 hours prior to arrival.

Vessels should call the terminal at least 4 hours prior to actual arrival.

Vessels are berthed from sunrise to sunset, but may depart at any time.

**Anchorage.**—Anchorage can be obtained 0.5 to 1 mile N or W of the E pier head.

**2.68 The Rio Aroa** (10°41'N., 68°18'W.) is located 11.8 miles NW of the disused Moron Terminal. This river is available only to shallow-draft vessels which transport copper ore from a mine inland to coastal vessels anchored off the mouth.

**Tucacas** (10°48'N., 68°19'W.) stands on the W entrance point of an extensive shallow lagoon on the NW side of the Golfo Triste. It was once an important shipping center for copper ore, but due to silting only a depth of 1m exists alongside the town wharf. There is a private wharf, 120m long, with a depth of 5.5m alongside its head. It can accommodate vessels up to 80m in length.

**Punta Tucacas** (10°52'N., 68°14'W.), low and wooded, is not prominent. Several low sandy cays lie close off this point are practically indistinguishable. A conspicuous wooded mountain range extends about 5 miles W along the N side of the peninsula forming the point. The ridge decreases gradually in height to the E and terminates rather abruptly at its E end. This ridge provides a fair landmark for offshore navigation, particularly from the N or S.

Small vessels can take sheltered anchorage, in depths of 16 to 20m, close SW of Cayo Sombrero, which lies close E of Punta Tucacas. This anchorage should be approached from the S.

**Caution.**—Vessels passing Punta Tucacas are advised to keep outside of the 40m curve, because of the numerous shoal

heads, with depth of 7.3 to 9.1m, which lie up to 3 miles SE, 2 miles E, and 2.5 miles NE of Cayo Sombrero. Vessels should not change course to the W until Cayo Borracho (10°58'N., 68°15'W.) bears 270°, distant 5 miles, because of the 10.4m shoal lying about 2.8 miles NNE of this latter cay.

**2.69 Punta Chichiriviche** (Punta Varadero) (10°55'N., 68°16'W.), a low and mangrove-covered peninsula, is surrounded by drying flats. It is connected to Punta Tucacas to the S by a narrow neck of land. Banco Lavendera, a 2.7m shoal patch, lies about 1 mile E of the point.

Cayo Borracho stands 3.3 miles N of Punta Chichiriviche and is considerably higher than the other cays in the area. The cays are more easily distinguished than the mainland.

**2.70 Puerto Chichiriviche** (10°55'N., 68°16'W.) (World Port Index No. 12100) must be approached between dangerous shoals and reef-fringed cays, some of which are buoyed. The channel should not be attempted at night. It is dredged to a depth of 9.8m.

**Tides—Currents.**—Heavy swells at the entrance raise rough seas within the harbor.

**Depths—Limitations.**—A 120m long wharf, with a depth of 7.3m alongside its head, fronts Puerto Chichiriviche. It can accommodate vessels up to 80m in length. The wharf is approached through a channel, marked by lighted buoys, that is dredged to a depth of 9.8m.

**Aspect.**—A prominent church spire and a house, with a black and white roof, stand in the village. An oil tank situated close SW of the pier and a windmill standing 0.4 mile SW of the church are also prominent landmarks.

**Pilotage.**—Pilots and clearance must be obtained at Puerto Cabello.

**Anchorage.**—Anchorage can be taken, in a depth of 9.1m, mud and sand, N of a line joining the pier and Punta Chichiriviche, and 0.2 mile off the W shore of the harbor. Cargo is worked from lighters at the anchorage.

**Directions.**—To obtain maximum depth, approach from the ENE. From a position about 5 miles off the entrance, steer with the tangent of the NW side of Punta Chichiriviche in line, bearing 245°, with the oil tank behind the pier. When about 0.5 mile off Cayo Pelon, the church spire and the house with the black and white roof will come in line bearing 270°. Alter course to this latter range and pass between Cayo Pelon and Cayo Peraza. This range may be kept open to the N about 2° to increase the distance off the ledge off Cayo Pelon. When Cayo Pelon is abeam to the S, alter course to 234° with the oil tank dead ahead and Cayo Peraza dead astern. This latter course will lead to the pier or the anchorage. Smart handling of the vessel is required when passing between the cays. With a following sea, the steering should be carefully watched and sufficient speed must be maintained to ensure proper control of the vessel.

## Puerto Chichiriviche to Cabo San Roman

**2.71** The coast between Puerto Chichiriviche and Punta San Juan, 16.5 miles NNW, is low and flat. Some fairly distinctive hills, up to 92m high, rise several miles inland. Cayo Borracho and adjacent shoals have been previously mentioned

in paragraph 2.69. The only other danger is La Piragua, a pinnacle on a reef, which is located about 1 mile SE of Punta San Juan.

**Punta San Juan** (11°11'N., 68°24'W.), with Cayo San Juan lying close NW of it, is low with no distinctive features. Obstruction lights were reported to be displayed at the head of Bahia San Juan, a small bay on the NW side of the point. Cayo del Noroeste, a small reef-fringed and scrub-covered cay, stands 3 miles NW of the NW extremity of the point.

The coast for about 4 miles NW of Punta San Juan is low and fronted by a sandy beach, but further NW the land becomes hilly with red clay bluffs.

**2.72 Punta Aguide** (11°21'N., 68°42'W.), a red clay bluff, is located 19.5 miles NW of Punta San Juan. It is 23m high but is prominent only from the E. A village and some palm trees stand on the point. Bajo Aguide and Bajo Uveros, each with a depth of 1.8m, lie about 4 miles NE and NW, respectively, of the point. Vessels should not proceed into depths of less than 40m when passing this point.

The coast between Punta Aguide and Punta Zamuro, 10 miles NW, is alternately bluff and low, and backed by rolling hills inland. Both points are marked by lights.

**Caution.**—An extensive area dangerous to navigation lies within an area extending 14 miles N from Cayo Noroeste, then 22.8 miles W, then 3 miles S to Punta Zamuro as best seen on the chart.

**2.73 Punta Zamuro** (11°27'N., 68°50'W.) is low and inconspicuous, but may be identified by a small village with scattered buildings on it.

Punta Sabana, about 17 miles WNW of Punta Zamuro, has a rounded knoll which appears prominent only from the E or W.

**Punta Manzanillo** (11°32'N., 69°16'W.) is a high bluff sloping to the W; it appears as the outer end of a ridge attaining higher elevations to the S.

Cerro de Ricoa, a 457m high prominent peak, stands about 7.5 miles SE of the point. This peak is the E summit of the coastal range which extends 20 miles to the W.

**2.74 Puerto Cumarebo** (11°29'N., 69°21'W.) (World Port Index No. 12090), situated 5.8 miles SW of Punta Manzanillo, consists of the roadstead fronting the town of Cumarebo and the oil terminal at Tucupido, about 2 miles NE of the town. The church steeple and light at Cumarebo, and the oil tanks and pier at Tucupido, are prominent.

Banco Cumarebo, a shoal extending 2.5 miles in extent with a least depth of 10.4m, lies 6 miles NNW of Cumarebo. A cement wharf for bulk cargo at Cumarebo is 600m in length and 10m in depth on the outer end.

An oil pier, 1,200m long, extends NNW from the shore at Tucupido and has a depth of 6.7m alongside its outer end. A platform, at the outer end, has a dolphin on either side of it.

**Pilotage.**—Pilotage is compulsory. The pilot boards 1 mile off the pier head.

**Anchorage.**—Anchorage can be taken, in a depth of 11m, about 1.3 miles N of the town.

The coast between Puerto Cumarebo and Punta Taimataima, 9.5 miles W, consists of sandy beaches backed by irregular



**Puerto Cumarebo**

sandstone bluffs and sand dunes.

**Punta Taimataima** (11°30'N., 69°31'W.), a high rounded bluff, is easily identified as the coast turns abruptly SW from it to form Bahia Vela de Coro. A light is shown from Punta Taimataima. The structure is difficult to identify from the offing against the background of trees.

**2.75 Le Vela** (11°28'N., 69°35'W.) stands in the SE corner of Bahia Vela de Coro. It is the port for the town of Coro. There is a pier situated 1.8 miles NE of La Vela, with ro-ro facilities and a depth of 6.1m alongside. The customhouse, a conspicuous white building with a red roof with "Aduana" painted in white on its top, stands in La Vela.

**Pilotage.**—Pilotage is compulsory. Vessels bound for this port should await the pilot either at anchor or underway 2 miles N of the lighted buoy moored about 1 mile NW of the light-house on Punta Taimataima.

**Anchorage.**—Anchorage can be taken, according to draft, in the roadstead off the town in the vicinity of the lighted buoy moored about 1 mile NW of the town. This anchorage may be approached by sounding as it is clear of dangers. With only a moderate breeze, a considerable sea is experienced in this bay. Punta Taimataima provides little shelter and breakers are nearly always present at the head of the bay.

**Caution.**—A wreck has been reported (2009) to lie approximately 1.5 miles NE of Le Vela about 0.3 mile offshore.

**2.76** The coast between La Vela and a point on the shore 19 miles NW forms the E side of Istmo de Medanos.

This isthmus is 2 to 3 miles wide and connects Peninsula de Paraguana to the mainland. It consists of low sand hills marked by swampy land and lagoons.

The E side of Peninsula de Paraguana extends about 33 miles NNW from the NE side of Istmo de Midanos to Cabo San Roman. This section of coast is generally low and sandy, but with few distinguishing marks. Cerro Santa Ana rises to an elevation of 853m, about 11 miles SW of Punta Adicora, and is visible for about 60 miles on a clear day. However, it is frequently covered by clouds. During the winter, haze usually

prevents this conspicuous peak from being visible from over a distance of 30 miles. A conspicuous group of buildings have been reported to stand 9 miles N of Cerro Santa Ana.

**Caution.**—An abnormal magnetic disturbance has been observed between Puerto Cumarebo and La Vela.

**2.77 Punta Adicora** (11°56'N., 69°48'W.), with the village of Adicora standing on it, is low and fringed by a reef. Reefs, some awash, lie within the 10m curve in this area and up to 2 miles offshore between this point and Punta Bravo, 3.8 miles NNW. A light is shown from Punta Adicora.

The coast between Punta Adicora and Cabo San Roman, 19 miles NNW, is generally low and backed by a plateau, about 30m high.

**Punta Brava** (12°00'N., 69°50'W.), though low and inconspicuous, is marked by a distinctive clump of mangroves. A prominent white house stands 3.5 miles WSW of the point.

**Punta Tomatey** (Punta Tumatey) (12°10'N., 69°56'W.), located 11.8 miles NNW of Punta Brava, is low, sandy, and covered with sparse scrub.

**Cabo San Roman** (12°11'N., 70°00'W.) is described in paragraph 3.3.



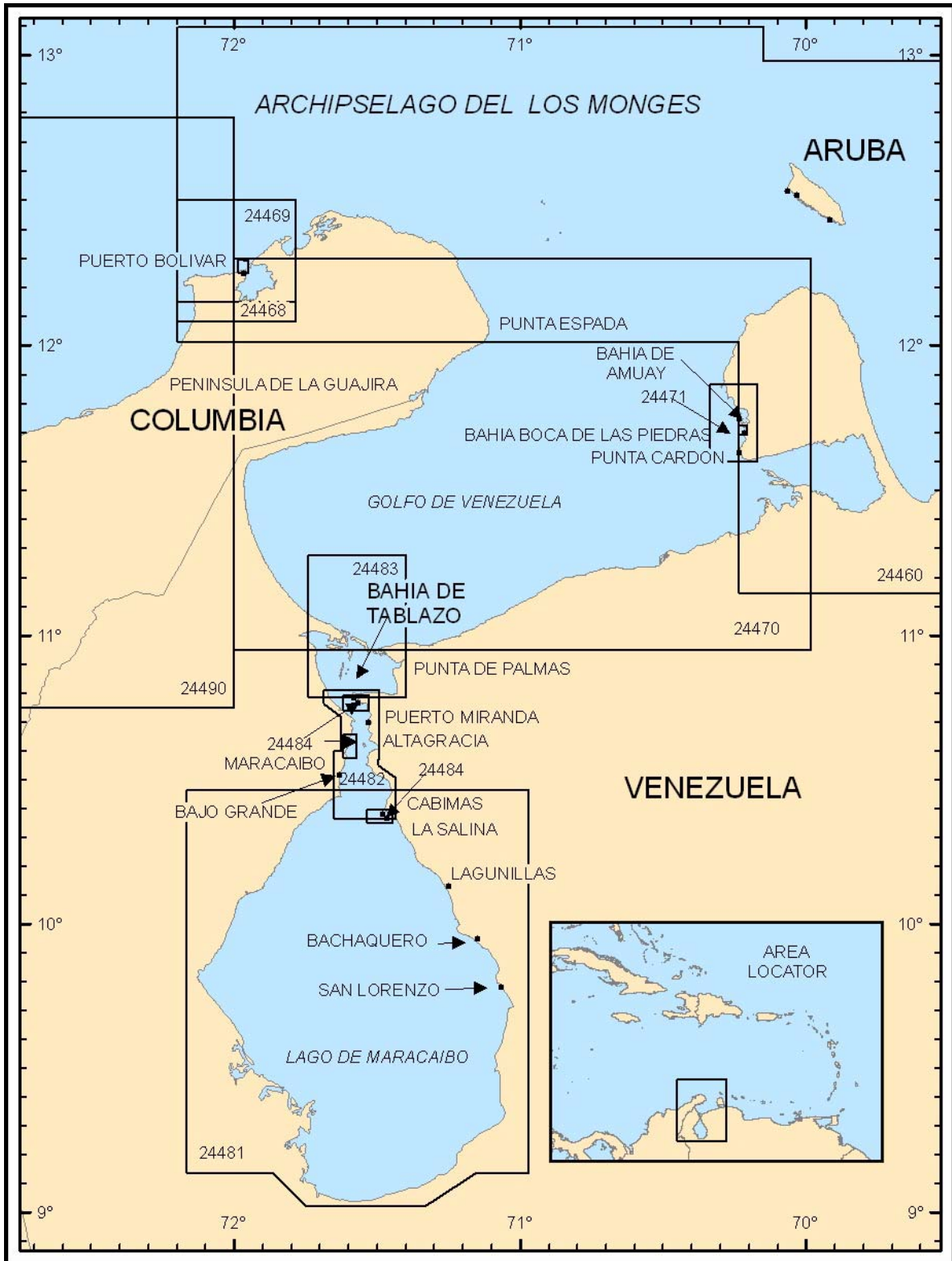

Additional chart coverage may be found in NGA/DLIS Catalog of Maps, Charts, and Related Products (Unlimited Distribution).

**SECTOR 3 — CHART INFORMATION**



Additional DNC library coverage may be found in NGA DNC 14 (Limited Distribution) disc within the README\GRAPHICS folder.

**SECTOR 3 — DNC LIBRARY INFORMATION**

## SECTOR 3

### GOLFO DE VENEZUELA AND LAGO DE MARACAIBO

**Plan.**—This sector describes Golfo de Venezuela (Maracaibo) and Lago de Maracaibo. The E and W side of the gulf are described in an N to S sequence. The lake is described from its N approaches.

#### General Remarks

**3.1** Golfo de Venezuela and Lago de Maracaibo form the outlet of one of the world's most important petroleum producing regions. Both crude and refined oil products are exported. The region supplies the important refineries at both Aruba and Curacao, the ports at Amuay, Las Piedras, and Puerto Cardon on Peninsula de Paraguana, and various ports in North America and Europe. The oil terminals within the gulf are situated along the E shore; the major terminals within the lake are similarly situated. Large tankers can be accommodated at some of the terminals within the gulf and lake.

Golfo de Venezuela is bordered to the E by Peninsula de Paraguana and to the W by Peninsula de La Guajira. The important oil ports of Bahia de Amuay, Bahia de Las Piedras, International Puerto Paraguana, and Puerto Cardon stand on the W side of Peninsula de Paraguana. Golfete de Coro, a large, foul, shallow bay lies along the S side of the peninsula and has no commercial importance. Ensenada de Calabozo, an extensive but relatively unimportant open bay, indents the SE side of Peninsula de La Guajira. Lago de Maracaibo is approached through a dredged channel at the head of the gulf.

Maracaibo, the principal city and port bordering the lake, is a port of entry.

**Winds—Weather.**—The weather is very irregular. The annual mean temperature is about 28°C. Winds in the vicinity of the outer channel are stronger from November through April and invariably from the NE quadrant. They vary in intensity from 10 to 55 knots, with the strongest winds being experienced in the late evening during February to April. During the months of June through August, the zone experiences frequent local squalls, generally from the E, known locally as “chubacos,” which can suddenly spring up with gusts up to 50 knots. These squalls usually occur in the late afternoon and the first part of the night lasting for 30 minutes to 1 hour. They have been experienced also outside the aforementioned session of normal occurrence. During “chubacos,” no maneuver can be effected.

The rainy season is generally from May through October. Rains are intense from May through October. Rains are intense but of short duration and are concentrated in the months of May, June, and August. Annual precipitation ranges from 460 to 500mm.

**Tides—Currents.**—The currents generally set W off the gulf entrance and attain rates up to 3.5 knots. An E set has been experienced in October and November between Punta Gallions and Los Monges. Apparently, there is a circulation S into the W part of the gulf, because the currents along the SE coast of Peninsula de la Guajira set SW and turn E along the S side

of the gulf as far as Punta Punas, where they turn N and dissipate in the middle of the gulf. Along the S shore the axis of the flow is just outside the 10m curve, where it sometimes attains a rate of 1 knot during the strength of the trade winds.

Along the E shore of the gulf the currents set SW and attain rates of 0.5 to 1 knot.

**Depths—Limitations.**—Depths range between 30m, lying 10 miles N of the entrance points of the gulf, and 10m and less lying within 0.5 to 8 miles of the shores in places. The S half of Ensenada de Calabozo has depths of less than 20m lying not more than 5 miles offshore. The dredged entrance channel leading to Lago de Maracaibo passes through a shoal area, with depths of 11m and less, which extends up to about 6 miles off the SW shore of the gulf.

The Maracaibo Harbor Master has announced (2008) new draft restrictions for vessels transiting the Maracaibo Canal, as follows:

1. High tide—PANAMAX vessels (maximum width of 32m) or smaller can have a maximum draft of 11.5m. Vessels over 32m in width, such as LAKEMAX, AFRAMAX, or SUEZMAX vessels, can have a maximum draft of 11.3m.
2. Medium tide—PANAMAX vessels or smaller can have a maximum draft of 11.5m. larger vessels can have a maximum draft of 10.7m.
3. Low tide—PANAMAX vessels or smaller can have a maximum draft of 10.2m. larger vessels can have a maximum draft of 10.0m.

#### Off-lying Dangers

**3.2 Los Monjes** (12°26'N., 70°54'W.), a group of barren islets and rocks, lies in the approach to the gulf, on the W side of the entrance. The channels which lie between these dangers are deep and clear. Monjes del Sur, the two S islets of the group, are steep-to, with one being 70m high. A light, with a racon, is shown from Monjes del Sur. Monjes del Este, lying 3 miles ENE of Monjes del Sur, is 43m high and also steep-to. Monjes del Norte, lying 7.3 miles NNW of Monjes del Este, consists of five rocks, the largest being 41m high. The rocks of the group are difficult to distinguish at night.

A pinnacle rock, awash, the position of which is doubtful, was reported to lie about 18 miles S of Monjes del Sur. An unsuccessful search was made for this rock in 1940 and again in 1970.

Discolored water, with yellow patches, is frequently encountered within the gulf. In the outer part, it has no significance.

**Caution.**—Unlighted fishing boats, with nets out, may be encountered up to 8 miles offshore in this area.

#### Golfo de Venezuela—East and Southeast Coasts

**3.3 Cabo San Roman** (12°11'N., 70°00'W.), composed of red cliffs, is the N extremity of Peninsula de Paraguana. The sea breaks heavily on the fringing rocks. The cape, marked by

a light, has been reported to be radar prominent.

From Cabo San Roman to Punta Macolla, 14 miles WSW, the coast consists of sand dunes interspersed with low rocky cliffs. Rocky ledges extend up to 1 mile offshore in places.

Anchorage can be taken, in depths of less than 18m, sheltered from E breezes, between Cabo San Roman and Punta Las Cruces, 9.5 miles WSW. Vessels should not anchor in a depth of less than 11m as the shorebank is steep-to.

**Punta Macolla** (12°06'N., 70°13'W.) is surmounted by a sand dune, 15m high. A few mangroves and the town of La Macolla stand on this point. A light is shown from the point and is sometimes visible across the peninsula from E of Cabo San Roman. Vessels should round this point at a distance of at least 3 miles to avoid the rocky ledges which extend up to 0.8 mile seaward. A dangerous wreck lies 10 miles SW of the point.

At Punta Jacuque, 7 miles SSW of Punta Macolla, there is a 2.9m shoal about 1.3 miles offshore. A dangerous wreck lies close to this shoal, 3 miles offshore. The area is always marked by discolored water and occasionally by breakers.

From Punta Macolla to Punta Salinas, 14 miles SSW, the coast is bordered by foul ground which extends up to 1.5 miles offshore in places. Punta Salinas consists of a sand spit, with mangrove trees on it. A conspicuous house stands on the shore of the Bahia Salinas, close E of the point.

Bahia Salinas is sheltered from winds between the NNE and SSE. Good anchorage can be found, in depths of 5 to 18m, close SE of Punta Salinas. No current is felt in the bay.

**Bahia Los Taques** (Punta Estanques) (11°49'N., 70°16'W.), entered close E of Punta Los Taques (Punta Estanques), has the town of Los Taques at its head. A prominent church stands in the town and a conspicuous water tower stands 0.5 mile E of it.

Anchorage can be taken, in depths of 9 to 13m, sand and shells, within the bay. The anchorage is approached until a conspicuous white house on a cliff just SE of the town bears 075°. A ship repair yard, consisting of a jetty and several buildings, has been established 2 miles SE of Punta Los Taques.

**Caution.**—Vessels transiting between Punta Macolla and Punta Los Taques should remain at least 6 miles clear of the coast. The coastal area between the two points is reserved for the use of shallow draft fishing vessels.

**3.4 Bahia de Amuay** (11°45'N., 70°14'W.), entered between Punta Chiraguara and Punta Adaro, lies 4.5 miles SSE of Punta Los Taques. It consists of a large landlocked bay, foul

in its N and S parts. The port facilities lie directly E of the entrance points and are used almost exclusively by large tankers loading oil products.



**Amuay**

**Amuay** (11°45'N., 70°14'W.) (World Port Index No. 12070) lies in the NW portion of the bay. The entrance to the bay is fouled by a detached shoal, with depths of 2.1 to 5.2m, which lies close N of the fairway, about midway between the entrance points. Punta Judibana, which has berthing facilities extending from it, has a conspicuous white house about 1 mile E of it and a similar house 1.5 miles SSE of it. A conspicuous water tank stands 2.3 miles NNE of the same point.

The entrance channel leading to port facilities has a dredged depth of 13.4m over a width of 0.1 mile and is marked by a lighted range in line bearing 075°. The channel is marked by lighted buoys.

**Winds—Weather.**—There is little rainfall at Amuay, where annual precipitation averages 300mm. The rainy season usually coincides with the Caribbean hurricane season, from August to November, although Amuay lies S of the usual hurricane track. During these months, calms are often experienced and winds from a W direction may be expected. Normal winds are steady from the NE, average force 4, with a maximum of force 8. Temperatures average about 30°C, with little variation from day to night or season to season.

**Depths—Limitations.**—The berthing facilities consist of four finger piers connected to Punta Judibana by a common causeway. Each pier provides a berth on each side; they are numbered 1 to 8 from the S to N. Crude oil and fuel oil are handled at all eight berths. For berthing information see the table titled **Amuay Berth—Information**.

Amuay—Berth Information				
Berth	Length	Depth	Maximum Vessel Size	Remarks
<b>Punta Judibana Refinery—Pier No. 1</b>				
No. 1	304m	13.1m	90,000 dwt	Petroleum products.
No. 2	304m	13.1m	90,000 dwt	
<b>Punta Judibana Refinery—Pier No. 2</b>				
No. 3	204m	12.1m	60,000 dwt	Liquid sulphur.
No. 4	204m	12.1m	64,000 dwt	Liquid sulphur.

Amuay—Berth Information				
Berth	Length	Depth	Maximum Vessel Size	Remarks
<b>Punta Judibana Refinery—Pier No. 3</b>				
No. 5	213m	12.1m	64,000 dwt	
No. 6	213m	12.1m	64,000 dwt	
<b>Punta Judibana Refinery—Pier No 4</b>				
No. 7	213m	11.8m	64,000 dwt	
No. 8	213m	12.1m	92,000 dwt	
<b>Punta Adaro</b>				
No. 1	240m	12.7m	80,000 dwt	

**Pilotage.**—Pilotage is compulsory and is available 24 hours. Pilots board from a tug about 1.5 miles WNW of Punta Adaro.

The numerical pennant of the International Code of Signals indicating the order of arrival of a vessel should be displayed. Pennant No. 1 indicates the first arrival. Vessels should forward their ETA at least 72 hours in advance to Amuay.

**Signals.**—A signal station stands on Punta Culata, situated close NE of Punta Adaro, and will give berthing instructions to arriving vessels.

**Anchorage.**—Good anchorage can be taken off the entrance to the bay, in depths of 18 to 32m, in the charted area W of Punta Chiraguara, heavy sand and silt, but care should be taken not to obstruct the entrance channel. Care should also be taken to avoid a patch, with a depth of 8.8m, located about 0.8 mile WNW of Punta Chiraguara. Additional anchorage is available in the charted reserved anchorage area close W of Punta Adaro. Small vessels can anchor within the bay, but clear of the turning basin off the finger piers.

**Caution.**—Two conspicuous wrecks, best seen on the chart, lie near the middle of the bay.

**3.5** From **Punta Adaro** (11°44'N., 70°14'W.), the coast trends nearly 2 miles SSE to Punta Piedras, a low point. The coast to within 0.5 mile of Punta Piedras is bordered by cliffs. There are no dangers outside the 10m curve, which lies 0.3 to 0.5 mile off this part of the coast.

Bahia Boca de Las Piedras, entered between Punta Piedras and the N extremity of Punta Carirubana to the S, is a sheltered bay. There are depths of 9m about midway between the entrance points, gradually shoaling toward the shores. Meneven Shoal, with a least depth of 4.7m, lies 0.8 mile SW of Punta Piedras. The shoal is marked on its SW side by a lighted buoy; vessels should pass at least 0.2 mile clear of the shoal.

**3.6 Las Piedras** (11°43'N., 70°13'W.) (World Port Index No. 12060) is a village standing on the NW side of the bay.

**Depths—Limitations.**—Muelle Naval projects about 0.5 mile WNW from the S part of the bay. Tanker berths, at the Las Piedras Pier, positioned N of Muelle Naval Pier, are situated on either side of the pier head. Additional berths, with alongside depths of 7 to 8m, are situated farther inshore along the pier. Strong NE trade winds during the winter sometimes make it difficult for a vessel to go alongside this pier.

Muelle de las Piedras extends 350m WSW from the N part

of the bay.

Muelle de Avencasa projects 350m WSW from the N extremity of Punta Avencasa.

Berth	Length	Depth	Remarks
No. 1	296m	12.5m	Smaller vessels use berths near pier head.
No. 2	204m	12.3m	—
No. 3	253m	12.3m	—
No. 4	253m	12.5m	—
Coke Pier	365m	13.0m	—

**Aspect.**—A conspicuous 12m high sand hill stands on Punta Avencasa; a noticeable monument is situated close WSW of it. A light is shown from the head of Muelle Naval.

**Pilotage.**—Pilotage is compulsory and is available 24 hours. Pilots board 1.5 miles WNW of the SSW pier head from a power boat.

**Anchorage.**—Anchorage can be taken about 1 mile NW of Muelle Naval, in depths of 16 to 24m, sand or mud. This holding ground is poor, so vessels may find better holding ground closer to the pier in a depth of 11m. However, vessels generally do not have to anchor, but go directly alongside.

**Caution.**—Two submarine cables, best seen on the chart, encumber the middle of the bay.

**3.7 Caleta Guaranao** (11°40'N., 70°13'W.), a small cove open to the W, lies 2 miles S of Boca de Las Piedras. The head of the cove is low and sandy, but the coast N and S is cliffy.

An obstruction lies close SSW of the W extremity of the pier. Three detached shoals, with depths ranging from 3.6 to 4.7m, lie 0.2 to 0.5 mile SW of the pier complex.

**Aspect.**—A water tower stands close inland of Punta Guaranao, the N entrance point; a similar tower stands SE of the root of the port pier.

**Pilotage.**—Pilotage is compulsory. The pilot boards 0.5 to 1.0 mile W of the pier head. Vessels should provide an ETA at least 72 hours in advance of arrival. The pilots and port utilize VHF channels 12 and 16.



**Puerto Cardon (Punta Cardon)**

Pilots for vessels bound for Lago de Maracaibo board off Caleta Guaranao. The pilot station is operated from Las Piedras and also provides service for Cardon.

**Anchorage.**—Anchorage can be taken, in a depth of 9m, mud and sand, about 0.5 mile offshore.

**Caution.**—A stranded wreck is located 0.2 mile WNW of Punta Zarobon.

**3.8 Puerto Cardon** (11°37'N., 70°14'W.) (World Port Index No. 12050) is entered between Punta Gorda to the N and Punta Cardon to the S. It is the site of a large oil refinery and several piers. Punta Cardon is a low, sandy spit with a village on it.

In the approach to the berthing facilities, there are no off-lying dangers. Depths of 12.2m and greater exist off the ends of all the piers.

**Depths—Limitations.**—There are four petroleum piers and one general cargo pier with alongside depths of 6.4 to 14.6m. There are two additional piers, 170m and 50m long, for coastal



**Puerto Cardon (Punta Cardon)**

vessels. For berthing information see the table titled **Puerto Cardon (Punta Cardon)—Berth Information**.

Puerto Cardon (Punta Cardon)—Berth Information					
Berth	Length	Depth	Maximum Vessel		Remarks
			Size	LOA	
<b>PDVSA Terminal</b>					
No. 5	285m	13.7m	44,000 dwt	256m	Petroleum and coke. Maximum beam of 36m.
<b>Pier No. 1 (Green)</b>					
No. 3	216m	12.0m	47,752 dwt		Petroleum products.
No. 4	216m	12.1m	47,752 dwt		
North inner	175m	9.1m			Petroleum products. Reported (2013) closed.
South inner	175m	9.4m			Petroleum products. Reported (2013) closed.
<b>Pier No. 2 (Red)</b>					
No. 3	216m	12.3m	47,752 dwt		Petroleum products.
No. 4	216m	11.8m	47,000 dwt		Petroleum products.
North inner	129m	5.9m			Petroleum products. Reported (2013) closed.
South inner	129m	6.5m			Petroleum products. Reported (2013) closed.
<b>Pier No. 3 (White)</b>					
No. 3	25m	13.5m	120,000 dwt	274m	Petroleum products.

Puerto Cardon (Punta Cardon)—Berth Information					
Berth	Length	Depth	Maximum Vessel		Remarks
			Size	LOA	
No. 4	25m	13.9m	120,000 dwt	274m	Petroleum products.
Pier No. 4 (Blue)					
No. 3	150m	11.8m	106,680 dwt	274m	Petroleum products.
No. 4	150m	13.7m	106,680 dwt	274m	LPG.



**Puerto Cardon Mole No. 5 and Gas Flare**

**Aspect.**—Two prominent 122m high chimneys stand 1.5 miles E of Punta Gorda. Two red and white banded chimneys stand near the root of Pier No. 1. A white church stands 0.3 mile ESE of Punta Botija and two radio masts stand close N of it. The gas flares and the lights of the refinery are conspicuous at night.

**Pilotage.**—Pilotage is compulsory. Pilots board from a tug, 0.5 to 0.8 mile off the pier heads, and operate on 24 hours. Vessels requiring berthing must give at least 72 hours advance notice of arrival. Because of the strong prevailing winds, vessels of over 9,000 grt must be ballasted prior to going alongside the piers.

Vessels should maintain a listening watch on VHF channel 12. A signal station, whose position is approximate, stands 0.2 mile ESE of the root of Pier No. 2.

**Anchorage.**—Within 2 miles W of the heads of the jetties, anchorage can be obtained, in depths up to 30m, mud, with some patches of small stones, sand and shells; the holding ground is reported to be good.

**Caution.**—A drilling platform is situated about 10 miles W of Punta Cardon. The lights and position of the platform may be subject to frequent change. Precautions must be taken when navigating near this area.

**3.9 Golfete de Coro** (11°35'N., 70°00'W.) is entered between Punta Cardon and Punta Codore (Punta de Cauca), about 16 miles SSW. It is shallow, unsurveyed, fouled by numerous coral heads, and available only to small craft with local knowledge.

The coast between Punta Codore and the entrance to Lago de Maracaibo, about 80 miles WSW, is low, backed by sand

dunes, and occasionally interspersed by cliffs. The 10m curve lies between 2.5 miles and 5 miles offshore; the bottom is fairly regular.

The mountains which stand in the interior can be seen from a considerable distance in clear weather.

From Cerro de la Teta, a 1,253m high peak rising 35 miles ESE of Punta Codore, a range extends SW, decreasing in elevation toward Lago de Maracaibo.

Zararida, a village with several large red-roofed buildings, is situated 12 miles WSW of Punta Codore at the mouth of the Rio Zazarida.

**Punta Borojo** (Punta Cienagas) (11°11'N., 70°52'W.) consists of a bluff point rising to a prominent 35m high hill close inland. A coastal light is shown 4 miles E of the point. A 12m high hill rises close to the coast, 19.5 miles SW of Punta Borojo. A white church with a steeple stands in the village of Casigua, about 4 miles inland and 8 miles E of the latter hill. A dangerous wreck, parts of which show above water, lies 21.5 miles NNW of Casigua; the wreck is reported to be radar conspicuous. An additional dangerous wreck lies 20.5 miles NNW of Casigua. A stranded wreck lies 23 miles NW of Casigua.

**3.10 Punta Gallinas** (12°28'N., 71°40'W.), the N extremity of Peninsula de La Guajira, is low, inconspicuous, marked by a light, and fronted by a sandy beach. A detached 7.3m shoal is located 8.0 miles ENE of the point.

From Punta Gallinas, the coast trends 5.5 miles E to Punta Taroa. The first part of this coast is low and difficult to distinguish, but from about 2 miles W of Punta Taroa, it is rocky, with cliffs from 15 to 18m high. Close SW of Punta Taroa is Puerto Taroa, in which a small bay affords good anchorage for small craft with local knowledge.

A stranded wreck is reported (2008) to lie about 2.5 miles N of Punta Taroa.

About 5 miles E of Puerto Taroa, a stranded wreck lies close N of Chimare.

Between Punta Taroa and Cabo Falso, located 16.5 miles ESE and marked by a light, the coast is generally low, sandy, and fringed by foul ground.

A stranded wreck was reported (1985) to lie close NE of Cabo Falso and to be radar conspicuous.

A customs house stands near the cape; a conspicuous white house is situated on the beach about 4.5 miles SE of it.

Between Cabo Falso and Cabo Chichibacoa, 6.5 miles SE, the coast is backed by sand dunes for 4 miles. The latter point consists of 12m high rocky cliffs.

Between Cabo Chichibacoa and Punta Espada, 14 miles SSE, the coast is backed by sand dunes as far as Punta de Santa Cruz and then is rocky in places. A pyramidal peak, 414m high

and conspicuous from the SE, stands 8.8 miles SSW of Cabo Chichibacoa. This coast is fringed by reefs in places.

Sierra de Macuira, a mountain range extending W and inland of Punta Espada, has several high peaks. The most prominent peak is 820m high and stands 14 miles W of the point. Pan de Azucar, 300m high and 5.5 miles WSW of the same point, is the E peak of this range.

**Punta Espada** (12°05'N., 71°07'W.), marked by a light, is the E extremity of Peninsula de La Guajira. Between this point and Punta Castilletes, 18.5 miles SW, the coast is rocky for about 8 miles and fringed by foul ground which extends up to 1.8 miles offshore in places. This section of coast should be given a wide berth when passing because of the irregular coral bottom.

**3.11 Castilletes Anchorage** (11°49'N., 71°20'W.), which lies between Punta Castilletes and Punta Perrett to the S, is encumbered by numerous shoals and rocks and has been declared a danger area to shipping. The village of Castilletes is situated 0.8 mile N of Punta Castilletes; conspicuous flat-topped cliffs stand in the vicinity. Isla Fuerte, small in extent, lies near the middle of the light located between the two entrance points. A detached 8.5m shoal lies 3 miles SE of Punta Perrett.

**Ensenada de Calabozo** (11°24'N., 71°40'W.), the large bay forming the SW part of Golfo de Venezuela, recedes between Punta Perrett and the NE side of Isla San Carlos, 50 miles SSW. The NW side of the bay is backed by a few sand dunes and several mountain peaks with defined summits. The principal peak is 615m high and stands 27.5 miles WSW of Punta Perrett. The W and SW shores of the bay are low and fronted by a sandy beach.

The 10m curve lies 1 to 3 miles off the N shore and 1 to 1.5 miles off the W and SW shores. There are few known dangers within the bay, including an obstruction reported to lie about 18 miles NNW of the E end of Isla San Carlos. A wreck, marked by a buoy, is located 10 miles SSE of Punta Bandola. A wreck lies 9.5 miles NNE of Lighted Buoy EM. Ensenada de Calabozo has no commercial value to shipping, except as a temporary anchorage.

## Lago de Maracaibo

**3.12 Lago de Maracaibo**, an extensive and almost landlocked body of water, is approached through a dredged channel. It leads S through Bahia de Tablazo and between the islands separating the shallow bay from Golfo de Venezuela.

The approach and the fairways of the various channels are marked by navigational aids. The deepening of the channels by continuous dredging has made the lake accessible to large tankers at the various oil terminals.

Numerous submarine cables are laid across the channel.

Maracaibo, the second largest general cargo port in Venezuela, is situated on the W side of the strait, 37 miles S of the outer sea buoy. Puerto Miranda, Cabimas, La Salina, Bachaquero, and San Lorenzo are the largest of the oil terminals situated within the lake proper.

**Tides—Currents.**—The tide ranges decrease toward the head of the lake and the influences are not felt above La Salina, where the range is negligible. There is about 0.3m difference between the range at Isla Zapara and the inner part of the

dredged channel.

Tide gauges are situated at Malecon and at Beacon E34 and Beacon T43. The tidal currents are generally weak at the entrance channel, but under some conditions, rates of up to 3 knots have been observed.

**Depths—Limitations.**—Outer Channel begins at Lighted Buoy EM (11°14'N., 71°34'W.). Pairs of lighted buoys mark the channel S to Isla Zapara, a distance of 14 miles. When entering and leaving the channel, vessels must leave this lighted buoy to port. This channel is dredged to a depth of 12.8m. The depths are subject to constant change and a copy of the latest depth bulletin, published by the Venezuelan government, should be obtained by vessels planning to enter the lake. It should be kept in mind that the controlling depths indicated in this bulletin refer to a 60m wide track lying on each side of the channel centerline.

Inner Channel continues on the same course as Outer Channel for about 10 miles, where the direction changes to 150°. The entire length of Inner Channel is 12 miles.

At Punta de Palmas, the dredged channel joins the deeper strait leading into the lake proper; however, this channel is divided into two marked fairways for inbound and outbound traffic.

Within the lake, the channel depths in the middle part of the lake are in excess of 30m. The depths in the various access channels leading to oil terminals vary with the particular terminal.

Vessels must take care to stay within the limits of the marked fairways. Inbound vessels must not use fairways for outbound traffic, and must not, under any circumstances, cross the bow of outbound vessels. Where vessels must cross fairways to reach terminals, outbound traffic has the right-of-way.

**Aspect.**—Few details of the coast can be seen from the outer buoy, which is moored 14 miles N of the lake entrance. Isla San Carlos, on the W side of the entrance, is low, with some sand dunes and low vegetation. Castillo San Carlos, with a pilot station, stands on the E end of the island. Isla San Bernardo and Isla Pajaros are both low. Isla Toas, with hills up to 122m high, lies 1 mile S of the E part of Isla San Carlos. Three framework towers stand on a hill on the W part of Isla Toas. A cross stands on the summit of a hill, 76m high, near the E end of the island.

It has been reported (2005) that a light is shown from a 24m high red structure on Isla San Carlos.

Isla Zapara, on the E side of the entrance channel, consists of sand dunes. A breakwater lining the E side of the entrance extends N from the NW end of Isla Zapara. The sand dunes attain heights of 32m toward the E part of the island; a village is situated on the S side.

**Pilotage.**—Pilotage is compulsory from Lighted Buoy EM inbound to any port area or terminal within the lake. Vessels should provide their ETA at Lighted Buoy EM 72 hours and 48 hours in advance and request permission to enter Outer Channel 24 hours and 12 hours in advance.

Pilots board off Punta Guaranao within the pilot embarking/disembarking zone bound by lines joining the following positions:

- a. 11°40.0'N, 70°15.5'W.
- b. 11°41.5'N, 70°15.5'W.
- c. 11°41.5'N, 70°16.5'W.





**Isla San Carlo Light**



**Castillo San Carlos**

d. 11°40.0'N, 70°16.5'W.

The government pilot station is situated at the SE end of Isla San Carlos. Radiotelephone or VHF channel 16 contact with the pilot station is to be established when within 10 miles of Lighted Buoy EM. A shift to VHF channel 12 or 14 will be directed. The pilot station should be advised of the ETA at Lighted Buoy EM and Buoy 28, draft, and destination. Permission to enter Outer Channel should be requested during this call.

Masters are warned to keep adequate speed in Outer Channel, even when embarking the pilot, as strong cross currents are encountered near Isla San Carlos and Isla Zapara. Pilot boats

are fast and are fitted with a flying bridge.

Maracaibo Pilotage Regulations require that inbound tankers, in ballast, while crossing the bar, shall not have greater than 2.4m difference between the fore and aft drafts. Unless this requirement is met, the pilot will not board the vessel.

The average speed of the vessels within the navigation channels will be 10 knots, and its masters and official pilots remain authorized to alter the same if required by navigational safety.

Vessels will keep a continuous watch on VHF channel 16 at disposition of the official pilot, until arriving at the port of destination within Lago de Maracaibo, and when outbound, until the pilot has disembarked.

Masters will report to the Pilot Station at 5 mile intervals, referencing starboard hand buoys when underway in the channel.

Loaded vessels in outbound navigation within Outer Channel will have priority over vessels entering the same channel. Therefore, the inbound vessels should not meet outbound vessels within the “critical zone” included between Buoys B21-B22 and Buoys E33-E34.

**Regulations.**—The following are extracts from the regulations issued by the Captain of the Port.

1. To define which vessels give way, the channels are classed as Primary Channels or Secondary Channels:

a. Primary Channels include Outer Channel, from Lighted Buoy B1 to Lighted Buoy E31; Inner Channel, from Lighted Buoy E31 to Lighted Beacon T55; and Maracaibo Lake, from Lighted Beacon T55 to 10°37'N.

b. Secondary Channels lead from Primary Channels; minor channels are the access or exit channels to the Secondary Channels. Ships not in any of the channels, but about to enter one, give way to ships in the channel. Ships entering major channels from minor ones give way to ships already in the major channel. In Inner Channel, no vessel shall pass another except in emergency.

2. The maximum speed for vessels in the reaches between Isla Zapara and Punta de Palmas is 10 knots. Every vessel navigating the channel should decrease speed when passing or being passed by another vessel in order to eliminate the effect of suction.

3. A vessel engaged in towing another will not be permitted to pass another vessel in any part of the channel, but must give way to vessels passing it who have made the prescribed signals, providing circumstances permit.

4. Vessels entering in ballast must have no greater difference in draft forward and aft than 2.4m.

5. The distance apart of vessels in the channel passing in the same direction should be 1 mile.

The harbormaster of Maracaibo has established a new draft limitation for vessels in the Maracaibo Lake Channel, as follows:

High Tide:	11.2m
Medium Tide:	10.7m
Low Tide:	9.9m

This new limitation was established in light of the necessity to maintain a regular flow of ships with large drafts in the Maracaibo Channel and accordance with seasonal conditions such as strong winds, tide current, and other factors reported by Channel Pilots during transit. The new limitations came into effect on December 15, 2009.

**Signals.**—A signal station is situated on the tower of the fort on the E end of Isla San Carlos. All vessels are required to salute the fort by dipping the ensign during daylight hours.

The following traffic light signals are displayed at night from the yardarm of the above signal station:

1. One red light—Entry prohibited.
2. One green light—Entry permitted.
3. Two green lights—A vessel is aground, but there is passage inward.
4. Two red lights—A vessel is aground and entry is prohibited.

Vessels navigating in the pilotage zone may use the signals listed in the accompanying table titled **Lago de Maracaibo—Pilotage Zone Signals**.

**Anchorage.**—Vessels can anchor, in depths of 15 to 18m, in the vicinity of Lighted Buoy EM when waiting for the tide. Good ground tackle is necessary because of sea and weather conditions that may be encountered.

Vessels are to anchor under the direction of the Port Captain.

If a vessel finds it necessary to anchor in the pilotage zone, anchorage must be taken in such a way so as not to obstruct traffic.

**Caution.**—The General Raphael Urdaneta Bridge, connected to both shores by a causeway, crosses the channel at a position close S of Punta Piedra. The maximum speed allowed in the approaches to and between the bridge piers is 5 knots. The vertical clearance of the bridge over the fairway of the channel is 45.1m.

Numerous uncharted oil rigs and drilling platforms are situ-



**The General Rafael Urdaneta Bridge**

ated outside the channel fairways in Lago de Maracaibo. Their lights and positions may be subject to frequent change. Vessels must strictly adhere to fairways to avoid collision with these structures.

Vessels must use extreme care in anchoring within the lake to avoid anchoring in the vicinity of submerged pipelines and cables.

Lago de Maracaibo—Pilotage Zone Signals		
Whistle signal	Additional day signal	Meaning
One long blast and one short blast	A cone, with point up, displayed at the starboard yardarm	I am proceeding at full speed
Three short blasts and one long blast	A cone, with point up, displayed midway up the starboard yardarm	I am proceeding at half speed
Three short blasts and one long blast, repeated twice	A cone, with point down, displayed at the starboard yardarm	I am proceeding at quarter speed
One short blast, two long blasts, and one short blast	A cylinder displayed at the port yardarm	My engines are stopped
One long blast and three short blasts	Allow me to pass	Allow me to pass
One long blast	—	You may pass me
Two long blasts and two short blasts	—	You cannot pass me
One long blast and four short blasts and the immediate hoisting of the signals prescribed by the Regulations for the Prevention of Collisions at Sea	—	I am aground or not under control
One short blast repeated at short intervals	—	I am to starboard of the channel; you can pass with care on my port side
Two short blasts repeated at short intervals	—	I am to port of the channel; you can pass with care on my starboard side

Lago de Maracaibo—Pilotage Zone Signals		
Whistle signal	Additional day signal	Meaning
Four long blasts repeated at short intervals	—	I am obstructing the channel; do not attempt to pass

The traffic concentration within the lake is dense. Small vessels will be encountered crossing the main fairways to the numerous small terminals in the lake area.

Dredges may be encountered at work in the main entrance channels. Ships are required to stop their engines and proceed at slow speed when passing these vessels.

### Ports and Terminals in Lago de Maracaibo

**3.13 Palmarejo de Mara** (10°48'N., 71°40'W.) is a small terminal that comprises an oil pier and a tank farm. There are four berths, but only the northernmost outer berth is used; the other three berths are no longer in use. This N berth is 129m long and has a depth of 6.5m alongside. Depths in the approaches from the SE are 5.5 to 7.3m. The terminal is used primarily by local tankers.

**3.14 Puerto Miranda** (10°46'N., 71°33'W.) (World Port Index No. 12035) is an oil terminal that consists of two jetties whose inner ends are joined and met by a causeway running from the shore and extending to the SW.

**Tides—Currents.**—The tidal range at this terminal is about 0.3m. The current, which sets at right angles to the pier, can at times be very strong and subject to sudden change. The ebb runs for 7 or 8 hours while the flood runs for 4 to 5 hours.

On arrival at Puerto Miranda, a berthing master will board to assist in docking the vessel as well as in undocking.

**Depths—Limitations.**—There are two finger piers with a total of four berths. For berthing information refer to the **Puerto Miranda—Berth information** table.

Puerto Miranda—Berth information			
Berth	Length	Draft	Remarks
<b>Pier No. 2</b>			
No. 1	277m	11.3m	115,000 dwt
No. 2	277m	11.0m	115,000 dwt
<b>Pier No. 3</b>			
No. 5	277m	11.3m	115,000 dwt
No. 6	277m	11.0m	115,000 dwt

**Anchorage.**—The anchorage is situated 1 mile NW of the terminal and is marked by buoys. The bottom is soft mud.

**Directions.**—When approaching from the S, vessels leave the primary channel after passing W of Lighted Buoy B65. The

maximum permitted draft in this approach is 10.4m. It has been reported (1992) that Canal Puerto Miranda, the approach channel, is no longer in use and is now part of the N anchorage. A new channel, marked by buoys, leads from Canal Interior between Lighted Buoy B61 and Lighted Buoy B63 through the S anchorage to the berths.

**3.15 El Tablazo** (10°45'N., 71°32'W.) (World Port Index No. 12037) is situated 1 mile E of Puerto Miranda and handles petrochemical products. The port, with two main jetties, each extending approximately 0.8 mile SW from the shore, can handle vessels up to 50,000 dwt, 198m in length, and 9m draft.

Berth	Length	Depth	Remarks
LPG North Berth	240m	9.5m	50,000 dwt
LPG South Berth	240m	8.5m	50,000 dwt
Solids North Berth	200m	9.1m	50,000 dwt Unloading of solids in sacks
Solids South Berth	250m	9.5m	50,000 dwt
Salt Pier	82.5m	5.5m	10,000 dwt
Heavy Cargo Pier	60.0m	3.5m	—

The port is approached by a channel running NE from the main channel in the vicinity of Lighted Buoy B63 and Lighted Buoy B64.

The jetties have berths on either side. On the N side of the Solid Cargo Pier. Dry cargo is handled at this jetty.

**Altigracia** (La Estacada) (10°42'N., 71°32'W.) has a berth used as a crude oil storage terminal; it is only used for loading in an emergency. The mooring buoys have been removed.

**3.16 Maracaibo** (10°38'N., 71°36'W.) (World Port Index No. 11960), the second-largest city and cargo handling port in Venezuela, stands on the W side of the lake, about 20 miles S of Isla San Carlos. The chief export is crude oil, but coffee is also exported in major quantities.

**Winds—Weather.**—Squalls, known locally as chubascos, occur most frequently between May and August, usually between 1400 and 1900, and last from about 30 minutes to 1 hour. Winds in the squall are generally S to SE and may attain a velocity of nearly 50 knots. A heavy rain usually follows these squalls.

Maracaibo—Berth Information			
Berth	Length	Depth	Remarks
No. 1	106m	4.5m	Coasters and small vessels.
No. 2	106m	4.5m	Naval.

Maracaibo—Berth Information			
Berth	Length	Depth	Remarks
No. 3	159m	4.5m	
No. 4	159m	6.7m	
No. 5	135m	5.3m	General cargo and containers.
No. 5A	60m	3.3m	
No. 6	180m	7.6m	General cargo and containers.
No. 7	180m	7.6m	General cargo and bulk grain.
No. 8	180m	9.2m	General cargo and bulk grain.
No. 9	155m	8.8m	General cargo and bulk grain.
No. 10	190m	8.7m	Grain.
No. 11	172m	9.7m	General cargo and bulk grain. Floating berth.
No. 12	172m	9.9m	General cargo and bulk grain. Floating berth.



Maracaibo Skyline

**Depths—Limitations.**—The following berthing facilities are situated on the N side of Bahía de Maracaibo. For berth information see the table titled **Maracaibo—Berth Information**.

**Pilotage.**—Pilotage is compulsory. Vessels should send an ETA message 72 hours prior to arrival. Messages are normally sent through Radio Curacao (PJC). A harbor pilot will board after clearance at the anchorage and take the vessel alongside one of the wharves. No vessel with explosives aboard is allowed in the dock area. The pilot may be contacted by VHF.

**Anchorage.**—There are two anchorage areas off the port for large vessels and one for smaller vessels. There are general depths of 6.5 to 15.7m in the anchorages, which may best be seen on the chart. An explosives anchorage area, which may also best be seen on the chart, lies centered about 2 miles SE of the harbor berths.

**3.17 Punta Piedra** (10°35'N., 71°36'W.) is a terminal that consists of an offshore oil mooring berth, with mooring buoys moored about 0.3 mile E of the T-head pier. Vessels up to 35,000 dwt, 175m in length, and 9.1m draft can use this berth. Berthing is by day only; unberthing is by day or night.

A jetty extends 0.5 mile ENE from a position 0.3 mile S of the W root of the General Rafael Urdaneta Bridge. Four mooring buoys are reported to lie off the head of the jetty.

**3.18 Bajo Grande** (10°31'N., 71°38'W.) (World Port In-

dex No. 12034) is a terminal that consists of an offshore oil platform with three loading berths.

Berth No. 1 is 229m long and has an alongside depth of 12.4m. It can accommodate tankers up to 55,000 dwt.

Berth No. 2 is 229m long and has an alongside depth of 9.4m. It can accommodate tankers up to 36,000 dwt.

Berth No. 3 is 260m long and has an alongside depth of 12.4m. It can accommodate tankers up to 85,000 dwt. The approach to this berth has a dredged depth of 13.7m.

Muelle de Caballetes, a natural gas liquid terminal, extends 1.8 miles E from a point on the shore a little over 1 mile S of Bajo Grande. A berthing platform at the head of the pier is 21m long. Vessels up to 213m in length and 11m draft can be handled.

**3.19 Punta de Palmas** (10°24'N., 71°34'W.) (World Port Index No. 12032) is situated 15 miles S of the port of Maracaibo. Punta de Palmas del Sur, situated close N, has a number of oil tanks and a submarine pipeline which extends 4.5 miles SE to Punta de Palmas platform.

Berth No. 1 and Berth No. 2, each consisting of two pairs of mooring buoys, are situated close E of the platform. They can accommodate vessels up to 254m in length, with respective drafts up to 11.6m and 11.4m. Vessels up to 80,000 dwt can be handled.

Berth No. 3 can be used by vessels up to 271.5m in length and 12.8m draft. Vessels up to 100,000 dwt can be handled.

Material Dock, on the S shore of Punta de Palmas del Sur, consists of two barges secured together. Only small shallow draft vessels can be accommodated.

**3.20 Cabimas** (10°23'N., 71°29'W.) and **La Salina** (10°22'N., 71°28'W.) (World Port Index No. 12025) are oil terminals that are operated by the Mene Grande Oil Company and the Creole Petroleum Corporation, respectively. The access channel leading to the berths has a least depth of 12.8m. There are two piers at Cabimas; the NW pier has only a depth of 4.6m alongside its outer end and is not used. The SE pier, with a depth of 4.3m alongside, can accommodate three small lake tankers and a small cargo vessel. The offshore oil berth, which is 203m long, has a depth of 10.7m alongside. Vessels up to 202m in length and 10.4m draft can be handled.

The La Salina Terminal consists of an artificial island, with two finger piers extending from its SW side. These piers, designated No. 6 Pier and No. 7 Pier, extend about 335m from the island and have depths of 12.5m alongside. However, a depth of 10.3m exists on the S side of No. 7 Pier, lying approximately 68m from its root. Tankers up to 274.5m in length and 11.9m draft can be accommodated alongside.

Pier No. 3 is an offshore loading facility situated W of the W extremity of the artificial island. Two berths are available at the pier. The W berth will accommodate vessels up to 210m in length and 7.9m draft. The E berth will accommodate vessels up to 175m in length and 7.9m draft.

**3.21 Lagunillas** (10°08'N., 71°15'W.) is located on the E side of Lago de Maracaibo. The harbor is used for the movement of personnel and the handling of boats and tugs. The quay is 433m long and a pier extends 94m from the quay.

**3.22 Bachaquero** (9°57'N., 71°10'W.) terminal is operated by both the Shell Oil Company and the Mene Grande Oil Company; it consists of a pier extending about 0.8 mile SW from the shore and has two berths on each side of its outer end. The N and S outer berths will accommodate vessels up to 20,000 dwt and 10.4m draft with respective lengths up to 186m and

181m. The inner berths have less water alongside.

It is reported that the port is not in service and all its aids to navigation have been removed.

An anchorage area for Bachaquero is situated about 0.5 mile SW of the pier. A mooring buoy is situated in the anchorage.

**3.23 San Lorenzo** (9°47'N., 71°04'W.) (World Port Index No. 11980) is situated about 10 miles SSE of Bachaquero.

**Depths—Limitations.**—A pier at San Lorenzo, with dolphins, extends about 0.5 mile SW from the shore and has a berth on each side of its outer end. The terminal is used only for handling crude oil and its product. Vessels up to 20,000 dwt can be berthed alongside. Maximum permissible drafts are 11.3m on the S side of the pier and 7.9m on the N side. Vessels up to 170m in length may use the N side of the pier and vessels up to 213m in length may use the S side. Tugs are required for mooring.

**Aspect.**—A lighted range, bearing 050°30', leads to the pier.

**Anchorage.**—Anchorage is available in the approach to the terminal in accordance with depths available and ship's draft.

**3.24 Le Ceiba** (9°28'N., 71°04'W.) is a cement port. Pier No. 1 is 195m long and has an alongside depth of 10.6m; it can accommodate vessels up to 8,000 dwt. Coastal bulk and bagged cement vessels are berthed. Pier No. 2 is 180m long and has an alongside depth of 11.5m; it can accommodate commercial vessels up to 30,000 dwt. A light stands on the coast about 6.5 miles N of Le Ceiba.

**3.25 Coloncha** (9°12'N., 71°45'W.), at the SW end of Lago de Maracaibo, is an oil terminal. A submarine pipeline extends 1.3 miles E from the shore to a platform. Another pipeline extends 4 miles ENE from the shore to a platform.

An offshore loading berth is situated close E of the easternmost platform. It consists of four mooring buoys and has a depth of 10.7m alongside. Tankers are berthed heading N. Anchorage can also be obtained off Coloncha.

A number of other small oil terminals are situated on the shores of the lake. They are available only to shallow-draft lake tankers; local knowledge is required to reach them.

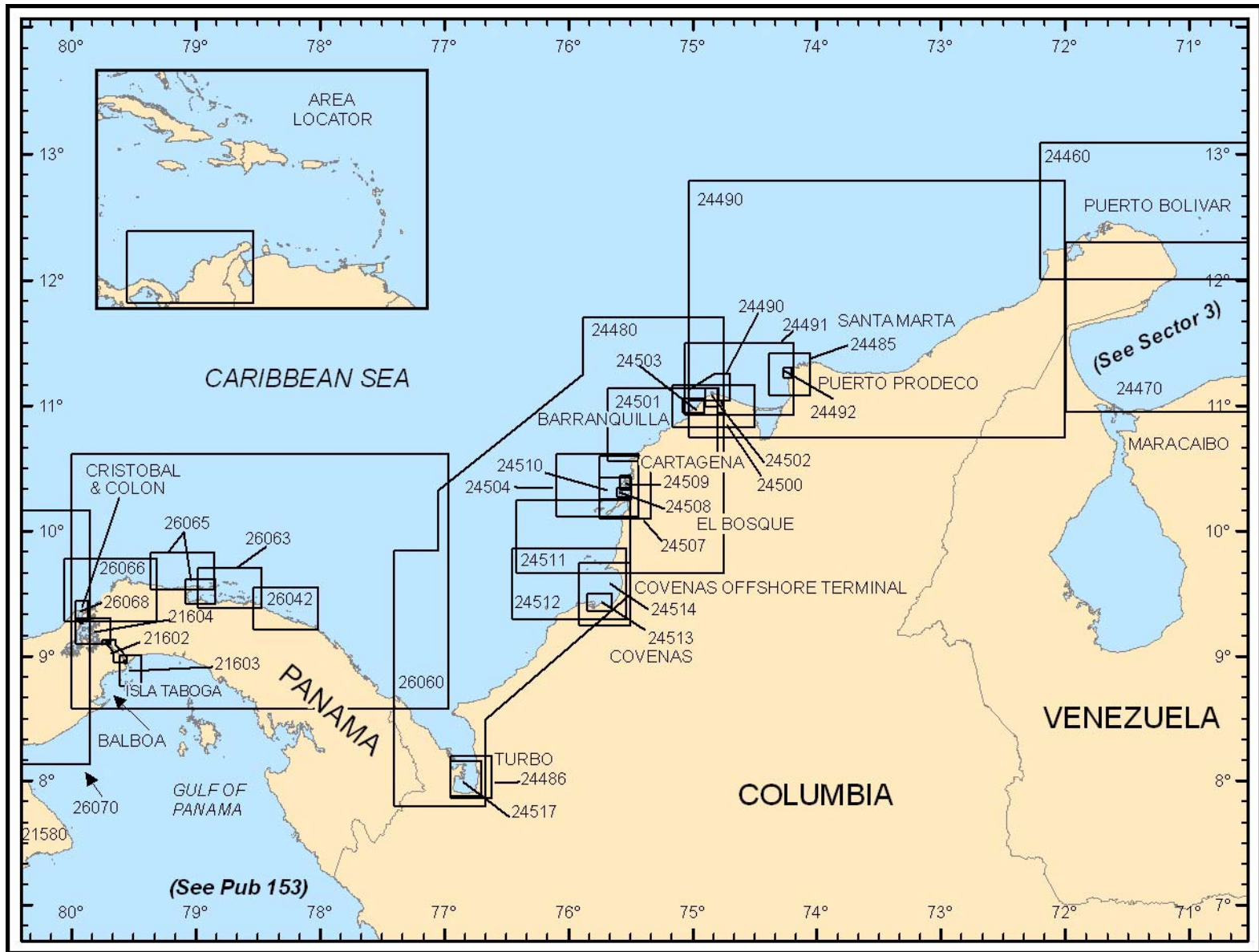

Additional chart coverage may be found in NGA/DLIS Catalog of Maps, Charts, and Related Products (Unlimited Distribution).  
**SECTOR 4 — CHART INFORMATION**

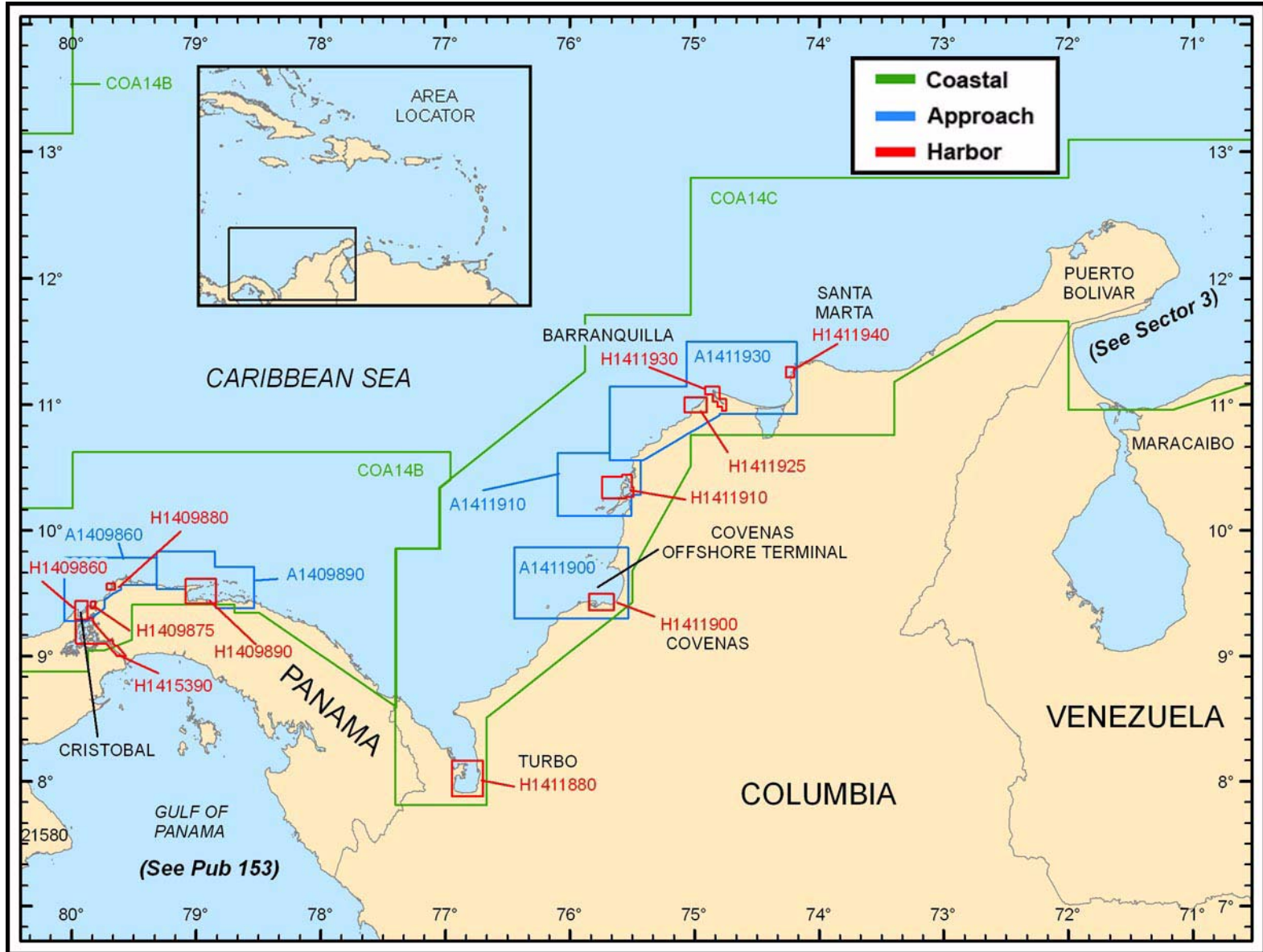

Additional DNC library coverage may be found in NGA DNC 14 (Limited Distribution) disc within the README\GRAPHICS folder.

SECTOR 4 — DNC LIBRARY INFORMATION

## SECTOR 4

### COLOMBIA AND PANAMA—PUNTA GALLINAS TO AND INCLUDING THE PANAMA CANAL

**Plan.**—This sector describes the N coasts of Colombia and Panama, from Punta Gallinas to and including the Panama Canal. The descriptive sequence is from E to W.

#### General Remarks

**4.1** Punta Gallinas and the Panama Canal in Panama, the E and W limits of the coastal area described, are about 530 miles apart in an approximate WSWENE direction. From Punta Gallinas, the coast first extends generally WSW for 205 miles to the mouth of the Rio Magdalena; then for about 200 miles and with considerable irregularity, it extends SW, sharply S, then SW again to Punta Caribana, the E entrance point of Golfo de Uraba.

Golfo de Uraba, with Bahia Colombia at its head, is a deep-water indentation 25 miles wide at its entrance, which extends 25 miles S from Punta Caribana. From Cabo Tiburon, the gulf's W entrance point, the coast extends NW for about 53 miles to Punta Brava, then WNW and W for 90 miles to Punta Manzanillo, the only indentations of any consequence are Golfo de San Blas, and of lesser importance are Santa Marta and Covenas.

Along this coastal stretch there are several bays of navigational importance and many sheltered anchorages. The major ports are Barranquilla and Cartagena; ports of lesser importance are Santa Marta and Covenas.

The N coast of Panama, between Punta Manzanilla and the entrance to the Panama Canal, extends SW for 27 miles. It is indented by numerous bays and backed by a mountainous topography for the first 22 miles; the remainder is lowlands. All of this coast is bordered by many closely off-lying islands and reefs.

Limon Bay, the principal bay, comprises the N inner approach to the Panama Canal and includes the harbors of Coco Solo, and Cristobal.

The Panama Canal, traversing the Isthmus of Panama in a SE direction for approximately 45 miles, connects Limon Bay on the Atlantic side to Panama Bay on the Pacific side.

**Winds—Weather.**—Except for the extreme E portion, this entire area is clear of the usual hurricane paths. The prevailing winds are the NE trades, which frequently assume a N or E direction, also a gusty character close inshore. These winds flow strongly from December to March and to a much lesser degree in the months of July and August. For the most part the winds are of a greater variety. The dry season is from November and December to April and May, often varying considerably and with the period of the E portion not entirely coinciding with that of the W. During the dry season, the winds are stronger and the climate is more favorable.

The wet season, comprising the other months of the year, is hot and humid and there is a great deal of evaporation. During the heavy rain squalls, many of which are of torrential intensity, the wind often flows with great fury for short periods. The

annual amount of rainfall is much higher in the W part of this area.

During the dry season, the wind may freshen to a velocity of 15 knots in the vicinity of the Panama Canal, but frequently exceeds 20 knots for a period of 24 hours or more. During the wet season in the same locality, the average wind velocity is about 8 knots, but greater velocities are experienced during passing local rain squalls.

The Northers occasionally reach as far S as Limon Bay, during the NE trade wind season, occurring from October or November to April, inclusive. They are strong and steady from the NE to the NW, blowing toward the equatorial belt of low pressure from an anticyclonic area of high pressure lying to the N. When at their worse, they generally flow from the NW. Their approach cannot be foretold either by barometric readings or otherwise, and they last from 1 to 5 days, but their maximum strength, when the wind velocity may reach 30 to 40 knots, rarely exceeds 24 hours duration. The average occurrence of Northers is barely 1 per year, but the swells and seas that accompany them are heavy.

In the vicinity of Cristobal, fogs rarely average more than 4 or 5 a year and normally are of short duration.

**Tides—Currents.**—The current along the Caribbean coast of South America is a continuation of that part of the Equatorial Current which enters the Caribbean Sea by way of the Gulf of Paria and the various passages, which lie between Trinidad and Martinique. Off Punta Gallinas, its velocity is between 1 knot and 1.5 knots, at this point its W direction begins to include the S. From Cabo de La Vela the main body of the current sets generally to the W, sometimes inclining to the WSW, and it diminishes in velocity as it expands over a greater area. On nearing the mouth of the Rio Magdalena the current is sometimes diverted to the NE, caused probably by the discharge from that river and by a coastal countercurrent.

West of the Rio Magdalena, a part of the main current is deflected SE into the Golfo de Uraba; between this part and the shore is the countercurrent. Off the Islas San Bernardo the countercurrent has a velocity of 0.4 to 1.5 knots and its direction is usually NE. From Golfo de Morrosquillo, SW and W, the coastal current is the general countercurrent of the area, the average velocity being from 1 to 2 knots, and in confined places 2.5 to 3 knots.

In the approach to Punta Manzanillo and the Panama Canal, from the vicinity of the mouth of the Rio Magdalena, it has been observed that there are various components both of the main Equatorial Current and of the general countercurrent. There also are certain irregularities, largely unpredictable, most probably due in greater or lesser measure to the influences of winds and to the discharge of rain swollen rivers. Occasionally, the normal current circulation may become so strongly affected that its direction may completely reverse itself while a hurricane is in progress to the N. The N gales which occur from time to time in the W Caribbean are very



likely to accelerate the countercurrent, the reaction to such an acceleration may temporarily discharge the normal current pattern over a very wide area.

So complex are the convergence, divergence, and other characteristics of the Caribbean current system that navigators of this area are cautioned to be especially alert at all times, taking nothing for granted and not hesitate to change quickly to a safer course should there seem to be even the slightest possibility of running into danger because of current vagaries.

**Punta Gallinas to Puerto Bolivar**

**4.2 Punta Gallinas** (12°28'N., 71°40'W.) has been previously described in paragraph 3.10. A shoal, with a depth of 11.9m, was reported to lie 13 miles W of Punta Gallinas.

**Bahia Hondita** (12°24'N., 71°44'W.), a small indentation about 5.5 miles SW of Punta Gallinas, is shallow and of no commercial importance. Punta Soldado is the rocky S entrance point to the bay. A conspicuous white house stands on the point.

Anchorage can be taken about 1 mile NW of Punta Soldado, in a depth of 12.8m, sand and gravel.

Bahia Honda, adjoining Bahia Hondita to the SW, is considerably larger and has depths of 9 to 12m in its central part. Anchorage can be taken in this bay, but it is reported to be less sheltered than off Bahia Hondita.

**Punta Canon** (12°23'N., 71°49'W.), the W entrance point to Bahia Honda, is bordered by very steep cliffs, 30m high, and surmounted by imposing hillocks which are easily identified from seaward. Banco Boca, a rocky area with two rocks with less than 1.8m, lies about 1 mile ENE of Punta Canon. Banco Boca can be seen during a smooth sea. An 11m depth lies 0.5 mile N of Banco Boca. Vessels entering the bay should pass close E of these two dangers. The E shore of this bay is low, sandy, and constantly changing due to high winds and changing sands.

From Punta Canon, the coast trends about 10.5 miles SW to Punta Coco, the NE entrance of Bahia de Portete. This stretch of coast is low, sandy, and bordered by rocky shoals. The coastal bank, as defined by the 30m curve, lies up to 3 miles off this coast.

Puerto Chico, a small bay, lies 1.5 miles SW of Punta Canon. A 4.6m high islet is located in Puerto Chico. Punta Coco rises to a prominent, rocky hill about 18m high.

Punta Gran Tonel, the SW entrance to Bahia de Portete, is bordered on its E and S sides by cliffs, 15 to 27m high.

**Bahia de Portete** (12°15'N., 71°55'W.), located about 10 miles SW of Bahia Honda, is entered between Punta Coco and Media Luna, a cliffy point 1 mile SSW. Local knowledge is necessary when entering the bay.

**Caution.**—The Colombian authorities have advised vessels to exercise care when sailing within coastal waters in depths of less than 30m, as the hydrographic information shown on the charts is derived from old survey data.

**Puerto Bolivar (12°16'N., 71°57'W.)**

World Port Index No. 11946

**4.3** Puerto Bolivar is situated on Bahia de Portete's SW

entrance point. The harbor has berths which will handle a variety of cargo, but handles mostly bulk coal.

**Winds—Weather.**—The prevailing winds here, from the NE or NNE, are usually light in the morning, but may increase to force 6 by evening.

**Tides—Currents.**—Tide and current information for the port is not currently available. It has been reported that the entrance has a SW current and the average tidal range is 0.3m.

**Depths—Limitations.**—The dredged channel, entered 2 miles NNW of the bay's SW entrance point, shows a least charted depth of 16.7m as far as the coal berth. The channel is 1.9 miles long and 225m wide. A turning basin lies S of the coal berth; it has a radius of 600m and a dredged depth of 9.2m. For berthing information refer to the **Puerto Bolivar—Berth Information** table.

Puerto Bolivar—Berth Information			
Berth	Length	Depth	Remarks
Coal Pier	270m	17.0m	A T-head pier with dolphins. Maximum vessels loa of 340m.
Coal Pier 2	—	—	It has been reported (2013) an additional coal pier is under construction.
Commodities Pier	270m	9.0m	
Tanker Berth	225m	9.5m	Located on the E side of the Commodities Pier. Vessels berth port side-to.
Ro-ro	—	5.0m	Located on W side of the Commodities Pier.



**Puerto Bolivar**

**Aspect.**—Piles of coal lie on the bays SW entrance point, while two white tanks stand close S of the commodities pier. A conspicuous red and white checkered tank stands 1.3 mile fur-

ther SSW.

The dredged channel is marked by lighted buoys and a lighted range.

It was reported (1995) that Buoy No. 5, Buoy No. 6, Buoy No. 7, and Buoy No. 8 are missing; Buoy No. 2 is unlit; and Buoy No. 3 is off station.

**Pilotage.**—Pilotage is compulsory. The pilot boards 1.2 miles NW of Buoy No. 1. Vessels should send an ETA 5 days prior to arrival. Pilots can be contacted (call sign: Puerto Bolivar Marine Operations) on VHF channel 14 or 16.

**Contact Information.**—The port can be contacted, as follows:

1. VHF: VHF channels 14 and 16
2. Telephone: 57-95-350-6511
3. Facsimile: 57-95-350-6512  
57-95-350-2151
4. E-mail: [cp14@dimar.mil.co](mailto:cp14@dimar.mil.co)

**Regulations.**—See Pub. 140, Sailing Directions (Planning Guide) North Atlantic Ocean and Adjacent Seas for details on regulations pertaining to vessels in Colombian waters.

Entry to the port is restricted. Permission should be obtained from the port authorities before proceeding to the anchorage, quarantine area, or the piers.

Bulk cargo vessels arriving in ballast are restricted to a maximum draft of 9m, as they are swung in the turning basin before being berthed. Arriving vessels must be carrying clean ballast in segregated tanks, with their holds swept clean. Bulk vessels must be gas free. Vessels over 100,000dwt are not allowed to berth at night, but may unberth at any time.

**Anchorage.**—The anchorages are open to NE winds. The charted general anchorage area, situated 2 miles NW of the bay's SW entrance point, has depths of 5 to 27m, sand. The Quarantine Anchorage area, centered 5.3 miles W of the same point, has depths of 11 to 37m, sand.

**Caution.**—Caution is advised in the entrance channel, as a vessel reported encountering a SW cross-channel set. The current reportedly caused a leeway of 10° until Buoy No. 7 and Buoy No. 8 were passed.

## Puerto Bolivar to Cabo de La Aguja

**4.4** Pilon de Azucar, 10.8 miles W of the entrance to Bahia de Portete, is a very prominent, sharp, rocky hill rising to a height of 81m. A white statute, 6m high, stands on the summit of this hill.

From Pilon de Azucar, the rocky coast trends about 3 miles SW to Cabo de La Vela (12°13'N., 72°10'W.), which is bordered by very steep cliffs on its N side. It is topped by a few conspicuous rocky hills, 45 to 81m high. Cabo de La Vela is low and sandy on its S side.

Isla Cusachon, a small low islet, lies close W of the cape. Cerros del Carpintero, a group of hills, rise to a considerable height about 5.5 miles SE of the cape and about 17 miles S. A short distance inland there is an unusual conical hill, mostly chalky in appearance.

Cabo de La Vela is marked by a light and reported to be radar conspicuous. A dangerous wreck lies 2 miles SSW of the cape.

**Anchorage.**—Anchorage, partially sheltered from the wind and seas, can be taken S of the outer extremity of the cape, in

depths of 12 to 16.5m. Care must be taken to avoid the dangerous wreck S of the anchorage.

**4.5 Punta Carrizal** (12°01'N., 72°11'W.), located 13.5 miles S of Cabo de La Vela, is a low, rounded point.

**Punta Castilletes** (11°50'N., 72°20'W.) lies 24 miles SSW of Cabo de La Vela. This part of the coast is low and Punta Castilletes can only be recognized by a clump of mangroves near it. Cerro de Los Remedios stands 16 miles inland and 5 miles farther NE is Cerro de Carrizal. These hills are the only elevations between Cerros del Carpintero, near Cabo de La Vela, and Cabo San Augustin, 105 miles SW.

**Manaure** (11°46'N., 72°27'W.), an open roadstead for loading bulk salt, lies about midway between Punta Castilletes and Punta Manaure, about 13 miles WSW. Vessels approach from the N and anchor, as convenient, 2 miles from a pier. Cargo is loaded from lighters at the anchorage. A light is shown, at an elevation of 27m, at Punta Manaure.

The coast between Punta Manaure and Punta de La Cruz, 13 miles WSW, has several small projections. Shallow water extends up to 2 miles offshore and vessels are cautioned to transit the area outside the 20m curve, which lies 3.5 miles from the shore.

**Caution.**—A submarine gas pipeline extends 6 miles NNW from the coast, originating 8 miles WSW of Punta Manaure. This pipeline is marked by orange buoys and a drilling platform (11°47'13"N., 72°46'51"W.) is situated at its seaward end. Precautions must be taken when navigating near this restricted area.

**4.6 Bajo Pajaro** (11°43'N., 72°44'W.), 8 miles W of Punta Manaure, is a dangerous sand bank, with depths of 3.7m between it and the shore. The outer edge is reported to lie 2 miles offshore and is reportedly always marked by breakers.

Between Punta La Vela and the mouth of Riohacha, about 11 miles SW, the coast is low and presents no conspicuous features. An obstruction, with a known depth of 5m and marked close N by a buoy, has been reported (2009) to lie about 4.5 miles NE of Punta La Vela.

**Riohacha** (11°34'N., 72°55'W.), with the town of the same name along its banks, lies 24 miles SW of Punta Manaure. The river is reported to have a navigable depth of 3.7m, but cargo is lightered out to the anchorage to be loaded. Only small coasters frequent this port. A light is shown W of the town.

**Anchorage.**—A general and quarantine anchorage area is situated 4.5 miles NNW of Riohacha, as seen on the chart. This anchorage is exposed and is not recommended from December to May because of the heavy swells which set in.

**Caution.**—A submarine cable extends W from the coast N of Riohacha toward Puerto Colombia.

**4.7 Punta Caricare**, 16 miles SW of Riohacha, separates two large lagoons. Banco Navio Quebrado, a shoal with a depth of less than 3.7m, lies about 2.5 miles NW of this point.

From Riohacha to Dibulla, the coast extends SW for 30 miles and then takes a W direction for about 39 miles to Cabo San Juan de Guia. This latter cape is radar conspicuous.

Anchorage can be taken off a small town near Dibulla. Vessels anchor more comfortably here than at Riohacha.

La Mesa is a very prominent flat-topped hill standing 2 miles

inland, about midway between Cabo San Augustin, 15.5 miles W of Dibulla, and Punta Don Diego, 7.5 miles farther W. A steep-to 14.6m bank is reported to lie about 3 miles N of Punta Don Diego. A dangerous wreck, with two masts above water, lies 2 miles NNW of the point.

**Sierra Nevada de Santa Marta** (10°49'N., 73°48'W.) are remarkable high mountains standing 25 miles S of Cabo San Augustin. The most prominent are two snow-capped sugarloaf peaks, the highest having an elevation of 5,700m. These mountains constitute the only really conspicuous landmarks on this coast for over 100 miles in either direction and can be seen clearly for a great distance offshore.

Los Ancones are a group of small islets and coves which lie between Cabo San Juan de Guia and Cabo de La Aguja. The coves are free from dangers and provide good shelter. They are separated by bold rugged headlands that are steep-to. When viewed from the W, they appear as a group of islands.

**Cabo de La Aguja to Santa Marta**

**4.8 Cabo de La Aguja** (11°18'N., 74°12'W.) is a short bold projecting headland, with Islote del Cabo de La Aguja located close N of it. The cape has been reported to be radar conspicuous.

From Cabo de La Aguja to Punta Canoas, about 90 miles SW, the coast is generally low and flat. West of the Rio Magdalena, the flatness is relieved by a series of coastal hills. Puerto de Barranquilla and Santa Marta are the only two ports of any commercial importance along this section of coast.

**Ancon De Taganga** (11°16'N., 74°12'W.), 2.3 miles S of Cabo de La Aguja, is surrounded by high land. Some remarkable white cliffs stand in the vicinity and can be seen for a distance of 10 to 12 miles offshore. These cliffs are good marks for Santa Marta, as there are no others of the same appearance on this part of the coast.

Islote del Cabo de La Aguja, a small irregular islet, lies about 0.5 mile N of Cabo de La Aguja. The fairway between them is fouled by two above-water rocks. Two above-water rocks lie within 0.5 mile W and NW of the islet.

**Santa Marta (11°15'N., 74°13'W.)**

World Port Index No. 11940

**4.9** Santa Marta, a small commercially-important port, stands in the NE corner of Bahia Santa Marta. This bay consists of an open roadstead protected from the prevailing NE winds.

**Santa Marta Home Page**  
<http://www.puertodesantamarta.com>

**Winds—Weather.**—The prevailing winds are the Northeast Trade Winds, which assume a gusty character when they reach the port after passing through the hills. Between the months of March and December, a local wind extending 2 to 3 miles offshore blows from the SW between 1000 to 1300.

**Tides—Currents.**—There is no regular tide in Bahia Santa Marta, but in the month of March the water has been known to

rise about 1.2m.

**Depths—Limitations.**—Except for the shoal on which Isla El Morro stands, the depths in the approach are deep and regular. Banco Pobeá, as defined by the 5m curve, is a coastal bank that extends up to 0.3 mile off the E shore of the bay. It was reported extending W because of the silt flowing from the river close S of the town. There are general depths of 9 to 37m and nowhere in the approach to the berthing facilities are the charted depths less than 9m.

The cove at the N end of Bahia Santa Marta has seven berths, numbered 1 through 5 from seaward on the E side and 6 and 7 on the W side. For berthing information see the table titled **Santa Marta—Berth Information**.

<b>Santa Marta—Berth Information</b>			
<b>Berth</b>	<b>Length</b>	<b>Depth</b>	<b>Remarks</b>
1	100m	4.5m	Coastal and containers
2	180m	11.5m	Cruise vessels and containers
3	140m	10.9m	Cruise vessels and containers
4	240m	13.7m	Grain
5	94m	6.1m	General cargo and bulk liquid
<b>Carbosan Coal Terminal</b>			
6	150m	18.3m	Coal
7	156m	15.2m	Coal

**Aspect.**—The town of Santa Marta stands on the E shore of the bay. Isla El Morro (Morro Grande), a precipitous islet, 61m high, with the ruins of a fort on it, lies in the NW part of Bahia Santa Marta. Two rocks, awash, lie close W of the islet. A light, with a racon, is shown from the island



**Santa Marta from E**



**Santa Marta from S**



**Isla El Morro (with light at top)**



**Sierra Nevada de Santa Marta and Rodadera Beach**

Morro Chico, a conical rocky islet, 25m high, stands close W of the N entrance to Santa Marta.

Inland of the extensive plain that fronts the shore are the lofty Sierra Nevada de Santa Marta that rise 40 miles SE of the town. These peaks are good marks for vessels intending to enter the bay. In the event these peaks are obscured, San Queme-

do, the highest mountain at the S end of the range behind the town, will be visible and may be used as a mark for entering the bay

A cathedral, with one dome, situated near the center of the town and a radio tower N of it are conspicuous. A white stone monument stands on the summit of a hill, about 0.8 mile NNW of the cathedral. Several tanks also stand in this vicinity.

**Pilotage.**—Pilotage is compulsory for all vessels larger than 200 grt. Pilots usually board vessels 0.4 mile SSW of Isla El Morro Light. Vessels should send their ETA 72 hours and 24 hours in advance.

The pilots can be contacted, as follows:

1. VHF: VHF channels 11 and 16
2. Telephone: 57-95-423-5894
3. Facsimile: 57-95-423-5895
4. E-mail: [bauprespilotos@bauprespilotos.com](mailto:bauprespilotos@bauprespilotos.com)

**Regulations.**—Vessels should limit their speed to 6 knots in Bahía de Santa.

**Anchorage.**—Vessels will find good anchorage as charted SE of Isla el Morro, in depths of 38 to 49m, with the cathedral bearing 090° or less. Because of the Northeast Trade Winds, vessels should allow a good scope of chain due to the strong winds, the depths, and the shelving bottom.

**Caution.**—A submarine cable lies near the coast S of Santa Marta and continues in a SW direction toward Punta Gaira. It can be best seen on the chart.

### **Santa Marta to Puerto de Barranquilla**

**4.10** Between Santa Marta and the Rio Magdalena, 37.5 miles WSW, a bay is formed by the coast receding 14.5 miles S to San Juan de Cienaga and then extending regularly WNW an additional 35 miles. The S shore consists of low, marshy land backed by extensive shallow lagoons. There are no known off-lying dangers seaward of the 20m curve.

**Punta Gaira** (11°13'N., 74°14'W.) is a bluff, with two above-water rocks lying close off it. Cliffs, with occasional sandy beaches, border the coast for 0.8 mile in a NE direction from Punta Gaira. There is a quay for barges, 110m long, which has a depth of 5.5m alongside.

**4.11 Pozos Colorados** (11°09'N., 74°15'W.) (World Port Index No. 11935) is an offshore loading berth for oil.

**Depths—Limitations.**—The berth consists of seven mooring buoys. It can handle vessels up to 70,000 dwt, 250m in length, and 18m draft. Several conspicuous tanks are situated on the shore NE of this offshore berth; a submarine pipeline extends from the berth NE to the shore near the tanks.

**Aspect.**—A conspicuous church, with a spire, stands in the town of San Juan de Cienaga, 8 miles S of the oil berth. A lighted range, in line bearing 085.5° leads to the berth. A lighted SPM, with a racon, is located NW of the submarine pipeline.

**Pilotage.**—Pilotage is compulsory and Pozos Colorados is a port of entry. Vessels should provide an ETA at least 24 hours in advance of arrival. The pilot boards from a launch about 1 mile seaward of the offshore berth. Ships will not be berthed at night.

**Anchorage.**—Anchorage can be taken S of the terminal, in a depth of 7.3m, with the church spire situated 2.5 miles WSW

of Cienaga bearing 160°, distant 2.5 miles. Vessels arriving at night anchor 1 mile seaward of the terminal.

**4.12 Puerto Zuniga** (11°08'N., 74°13'W.) is an open roadstead port for the export of coal located on the coast S of Pozos Colorados. Vessels anchor 1 to 2 miles offshore, where they are loaded by barges and floating cranes. The port consists of the additional facilities of Puerto Prodeco (Puerto Carbonero) and Puerto Drummond (Puerto Carbonero de la Loma). Puerto Prodeco has two berths, identified as Alpha and Bravo. Both are contained in an anchorage 2 to 2.5 miles W and NW of the T-head shore terminal. Alpha mooring has a depth of 18m and Bravo has a mooring depth of 10.5m. Puerto Drummond has two lighted mooring buoys on the SW limit of the same anchorage approximately 3.5 miles NW of its pier.



**Puerto Prodeco (Puerto Carbonero)**

The coast between Puerto Zuniga and Punta Faro, 40 miles to the W, is low and swampy. It fronts the lagoon Cienaga Grande de Santa Marta. The coast is undergoing constant change and charted depths may be inaccurate. Caution is advised in the vicinity of this stretch of coastline. A stranded

wreck has been reported (2009) to lie 3.75 miles NNE of Cienaga.

**Puerto de Barranquilla (11°00'N., 74°48'W.)**

World Port Index No. 11930

**4.13** Puerto de Barranquilla comprises the outer 10 miles of the Rio Magdalena, which is the main artery of commercial traffic of Colombia. The wharves and the city are situated 10.5 miles within the river mouth which is navigable under normal conditions for a distance of 800 miles inland. Small local vessels can ascend to the city of Dorada, 592 miles upriver.



**Barranquilla from E**

**Winds—Weather.**—The Northeast Trade Winds blow strongly from December to March and again, but to a lesser extent, from July to August. Winds from the other direction are generally light. The locality is out of the hurricane area.

At times, entry cannot be made when the trade winds blow. Generally, these winds and accompanying seas moderate during the night so that the early morning hours are the most desirable time of entry.

<b>Puerto de Barranquilla—Berth Information</b>			
<b>Berth</b>	<b>Length</b>	<b>Depth</b>	<b>Remarks</b>
Matitimo Terminla	1058m	11.0m	Breakbulk, ro-ro, dry bulk, liquid, and containers. Vessels are restricted to maximum draft of 9.0m.
Fluvial Dock	550m	3.6m	Located in South Basin. Yachts and tugs.
<b>Monomeros Colombo-Venzolanos (Private Berths)</b>			
Pier No. 1	180m	6.7m	A pontoon barge is placed between vessel and berth.
Pier No. 2	180m	7.0m	A pontoon barge is placed between vessel and berth.
Atlantic Coal Pier	170m	8.8-9.1m	Maximum air draft of 14m. Draft subject to river conditions.
Cementos de Caribe	190m	8.8-9.1m	Cement. Maximum air draft of 14m. Draft subject to river conditions.
Sociedad Portuaria del Notre	242m	—	Coal and steel. A maximum vessel loa of 242m is allowed. Draft to be calculated on the day via harbormaster.
<b>Tanker Berths</b>			
Colterminales	180m	10.9m	Petroleum products.

Puerto de Barranquilla—Berth Information			
Berth	Length	Depth	Remarks
Shell Union Carbide	147m	6.4m	Petroleum products.
Esso Columbian	—	7.6m	Oil berth for small tankers.
Gracetales	—	—	Oil berth. Consists of several flat-top barges permanently moored to a platform.

**Tides—Currents.**—The tidal range is about 0.3m at the river entrance, but is very irregular. The rise has very little effect on the river current which always flows out.

When the water level is low in the river, generally from February to April and August to October, the river current does not exceed 2 knots. When the water level is high in the river, generally in July and November, the current attains a velocity of up to 6 knots, and floating debris and logs are encountered. The discolored water discharged from the river may be seen a long distance seaward of the entrance.

An ocean current, which varies according to the direction of the wind, sets across the river entrance. It normally sets E, but during the period of the Northeast Trade Winds, there is a slight increase in the height and a noticeable steeping and shortening of the waves. This is greatest at high river and on a rising tide during the period of the NE trades. At such times, an entering vessel is best navigated at a good speed.

**Depths—Limitations.**—The approaches are deep and the 20m curve lies close N of the breakwaters at the mouth of the river. A shoal, with a depth of 7.5m, lies 2.3 miles WNW of the head of the W breakwater; and dangerous wrecks lie about 1 mile WSW and close NNE of the W breakwater.

Mariners are cautioned not to attempt to enter the river without the most recent information concerning depths and other conditions from the local authorities, as depths in the entrance are subject to silting. The maximum draft is authorized by the port administration on the basis of soundings taken every other day.

Dredging operations are continuous. Extensive shoaling has been reported immediately W of the W breakwater head. Less water than charted was reported (1974) to lie about 1 mile NE of the E breakwater.

A 150m-wide channel, maintained to a depth of at least 9.1m and marked by lighted ranges and buoys, extends from the river entrance at Bocas de Ceniza (11°06'N., 74°51'W.) to Puerto Barranquilla. The N side of the channel may not meet the maintained depth due to river migration. For berthing information see the table titled **Puerto de Barranquilla—Berth Information**.

**Aspect.**—The coast E of the river entrance consists of flat sand dunes. To the W of the entrance, the coast consists of flat, partly wooded islands. An old disused lighthouse stands 3 miles SE of the entrance and a conspicuous building stands 2 miles farther E. A conspicuous white sand hill, 8m high, stands 1 mile E of the old lighthouse. A conspicuous pilot house stands 0.3 mile SSE of the W breakwater head. The breakwater heads are reported to be radar prominent.

A stone groin, marked by a light, extends from the E breakwater between Light No. E1 and Light No. E3 at Punta Faro. Four stone groins, each marked by a light, have been constructed on the NE bank of the river, E and SE of Las Flores, and

close W of Isla 1972.

**Pilotage.**—Pilotage is compulsory for all vessels over 200 gross tons. An ETA should be sent 48 and 24 hours in advance. The pilot boards 1.5 miles WNW of the breakwater; if the pilot is unable to board because of heavy swell, the pilot vessel will lead the vessel into the river.

Pilots can be contacted on VHF channels 13 and 16. The pilot vessel can be contacted on VHF channel 14.

**Anchorage.**—Anchorage can be taken, in depths of 18 to 22m, as close as 0.8 mile W of W breakwater. However, vessels are advised that a dangerous wreck lies about 1 mile WSW of the head of the W breakwater. This wreck is not visible and vessels are advised that when anchoring, a safe distance of at least 1.5 miles should be maintained from the W breakwater. Vessels are also advised to obtain good soundings prior to anchoring because the depths increase rapidly to the N and W of this anchorage.

It has been reported (2009) that depths in Anchorage Area No. 2 and Anchorage Area No. 3, E and SE of Las Flores, are about 2m less than charted.

**Caution.**—It has been reported (2009) that the bearing of the leading lights marking the approach to Boca de Ceniza is now 139°. Numerous changes to buoyage have taken place, with some buoys being moved and renumbered and other buoys completely removed. Local authorities should be consulted for the latest information on aids to navigation, depths in the anchorage areas, and depths alongside the maintained channel.

## Puerto de Barranquilla to Punta Canoas

**4.14** The coast between the Rio Magdalena and Punta Hermosa, 13 miles SW, is formed by a succession of flat, wooded lands. Isla Verde, the W of these islands, is a low spot of land covered at all stages of the tide, with its S extremity extending SW.

**Caution.**—Because of the constant changing limits of these islands and the submarine cables in the vicinity, vessels are advised to navigate with care when in this vicinity.

**Bahia de Sabanilla** (11°00'N., 75°00'W.) recedes 4 miles E between Isla Verde and Punta Morro Hermosa, 2.5 miles S. This point, marked by a light, rises in steps to an elevation of 124m and is yellowish. Depths of 9 to 18m exist in the central part of the bay, but are reported to be much less around the shores because of silting.

**Caution.**—Several submarine cables lie near the seaward coast of Puerto Colombia and continue in a NW direction. They can be best seen on the chart.

A stranded wreck is located 4.5 miles W of Punta Sabanilla. Vessels are cautioned not to approach within 1 mile of the

pier head at Puerto Colombia, in the SE part of the bay. This port was formerly used by commercial vessels, but is no longer in service.

It has been reported that no shelter is provided from the prevailing winds within the bay in sufficient depths for a vessel to lie with safety. Winds up to 20 to 25 knots can generate seas up to 2.4 to 3m.

Between Punta Morro Hermosa and Punta de La Garita, the coast extends about 4 miles S and then about 15 miles SW. Hills up to 122m high stand close to the coast with higher hills inland. Except for a detached 7.3m shoal lying about 4.5 miles NE of Punta de La Garita, depths of over 9m extend to within 1.5 miles of the shore.

An unnamed point, located 6 miles SW of Punta Hermosa, is reported to be radar prominent.

**Punta de La Garita** (10°48'N., 75°16'W.) is a low, sandy projection. A conspicuous tower and a building stand 0.8 mile S of this point.

Between Punta de La Garita and Punta Canoas, the coast extends 21 miles SW and is bordered by a large coastal bank. This bank, including the detached dangers with depths of 6.4m lying off its outer end, extends up to 8 miles seaward, about 11 miles W of Punta de La Garita.

This section of coast is generally low and sandy, with lagoons close within the beaches in places, but a group of hills approach the coast 8 miles SW of Punta de La Garita and also 15 miles SW of the point.

## Punta Canoas to Cartagena

**4.15 Punta Canoas** (10°34'N., 75°31'W.), low and rocky, is closely backed by hills. Several shoal depths lie within 1.5 miles of the point.

Between Punta Canoas and Punta Caribana, 143 miles SW, the coast extends S for 70 miles to the small port of Covenas, in the S part of Golfo de Morrosquillo. It then extends for 25 miles in a general W direction and continues S for an additional 64 miles. This coast presents a varied aspect of high, steep land, narrow coastal plains, low shores covered with mangroves, and prominent hilly landmarks. There are several bays and inlets off this section of coast, the most important being Bahia de Cartagena, in which lies the port of Cartagena. There are numerous small towns and villages along this stretch of coast, but the aids to navigation are sparse.

**Caution.**—Several submarine exercise areas, which may best be seen on the charts, lie 13 miles WNW and 18 miles W of the summit of Isla Tierra Bomba, just N of the S entrance point of Bahia de Cartagena. As these areas are reserved for the Colombian Navy, vessels are requested to navigate with care and keep a good lookout in this vicinity.

Between Punta Canoas and the city of Cartagena, 8.5 miles S, the coast is low to Punta Manzanilla, a conspicuous gray and white cliff, 46m high, about 4 miles S. Punta Manzanilla is reported to be radar prominent.

Banco Playa Grande, as defined by the 20m curve, lies between 3 and 5 miles offshore and has depths of less than 9m extending up to 3.5 miles WSW from Cartagena.

**Bancos de Salmedina** (10°23'N., 75°40'W.), two detached shoal areas of sand and coral, lie between 3 and 6.5 miles offshore, about 14 miles SW of Punta Canoas. The W bank has a reported least depth of 4.5m and is separated from the easternmost bank by a passage, about 1 mile wide. Breakers have been reported over this bank. The E bank has a least depth of 4m and is marked by a light on its NW side.

## Cartagena (10°25'N., 75°32'W.)

World Port Index No. 11910

**4.16** Cartagena, the largest and most secure harbor on the N coast of Colombia, lies in the E part of Bahia de Cartagena to the NE of Isla Tierra Bomba and Isla Draga. Boca Chica, the entrance to the bay, lies between these two islands 6.8 miles SSW of the city of Cartagena. Ample alongside berthing facilities are provided for vessels of all classes able to enter.

**Winds—Weather.**—In the season of strong winds, from January to June, the sea breeze sets in from the W and then veers NW; at about noon, it blows parallel to the coast.

During the wet season, from April to October, the climate is hot, and in the early morning, land breezes are usually preceded by rain squalls of short duration. During the dry season, from November to March, the winds are stronger and the climate more healthful.

**Tides—Currents.**—The mean HW interval at Cartagena is 11 hours 42 minutes. The maximum range is about 0.3m and the mean range is 0.1m.

The tidal current off the entrance to the inner harbor sets ESE during the flood at a velocity of 0.5 knot and to the W at the same velocity during the maximum ebb.

**Depths—Limitations.**—The entrance channel through Boca Chica has a general depth of 14.7m. The general depths in the outer harbor are 23.8 to 29.3m and 10 to 18.3m in the inner harbor. The E channel of the inner harbor has a least depth of 12.3m.

Bahia de Cartagena is an irregularly-formed bay, sheltered on its E side by the mainland and on the W and S sides by Isla Tierra Bomba. A submerged rock wall extends between Isla Tierra Bomba and the W point of Boca Grande, providing shelter for the N anchorage area. This submerged wall encloses an inner harbor, an outer harbor, the bight in the N part of the bay, the facilities fronting the city, and the oil terminal of Mamonal.

Most of the shoals which lie in the outer parts of both the inner and outer harbor, and which are considered to be obstructions to vessels entering and leaving, are marked by lighted buoys.

Terminal Muelles El Bosque is located on the Isla del Diablo Island, S of the port of Cartagena, within the inner bay.

The port authorities at Cartagena would like to prohibit passage of medium and deep-draft vessels through the present channel at Boca Chica due to the deteriorating effect of the channel. The maximum draft allowed via Boca Chica is 11.7m and the channel cannot be easily deepened due to the rock bottom.

Pier information can be found in the accompanying table titled **Cartagena—Berth Information**.



Cartagena—Boca Chica—Isla Draga from NW



Cartagena—Boca Chica—Isla Draga from W





**Cartagena—Boca Chica—Fuerte San Fernando from W**



**Cartagena—Boca Chica—Fuerte San Fernando from E**



Cartagena—Boca Chica—Isla de Tierra Bomba tower from SE



Cartagena—Colclinker Terminal



Cartagena—Inner Harbor—Punta Castillo Grande and Naval Club Light from N



Cartagena—Inner Harbor—Punta Castillo Grande and Naval Club Light from N



**Cartagena—Inner Harbor—Stranded Wreck NW of Punta Castillo Grande**



**Cartagena—Inner Harbor—Maritime Terminal**



**Cartagena—Inner Harbor—Maritime Terminal and Cerro La Popa**



**Cartagena—Inner Harbor—Cerro La Popa from WSW**



Cartagena—Inner Harbor—Statue



Punta Castillo Grande Light



Cartagena—Pilot Vessel

**Mamonal** (10°22'N., 75°32'W.) (World Port Index No. 11905) is a zone of privately-owned industrial berths situated 5 miles S of Cartagena.

There are two oil terminals in the bay. Refinery Terminal (Mamonal Oil Terminal) is connected to the shore by seven submarine pipelines;. The mooring master boards about 0.5 mile off each facility and remains onboard throughout the stay of the vessel. **Cartagena—Berth Information.**

**Aspect.**—Cerro La Popa, a 156m high hill with the ruins of an old convent and an illuminated cross near the top, stands 1 mile E of the city. The city has many conspicuous spires, stacks, and towers. Obstruction lights are displayed from some

of these towers. The radio tower at the summit of the hill and the tower at the pilot station are reported to be conspicuous. Castillo Grande Light, the Cerro La Popa building on a hill N of the inner harbor, and a statue in the inner harbor are also conspicuous. A hotel, with twin spires which are illuminated at night, stands near the beach on Castillo Grande SW of the city. As there are many high-rise hotels in the area, this hotel is conspicuous in daylight because of its low profile and red tile roof. The summit of Isla Tierra Bomba is 84m high.

Radar prominent landmarks include the cliffs on the W point of Isla Tierra Bomba, Fort San Fernando, the Mamonal oil pier, the water tower E of Isla Bruja, the tank N of the oil pier, Punta Chabo, Punta de La Playa de Viente, Maritime Terminal Pier No. 1, and Punta Castillo Grande.

**Pilotage.**—Pilotage is compulsory for vessels and is available 24 hours. The pilot boards 0.8 mile SW of the fairway lighted buoy, in the entrance to Boca Chica. The signal for a pilot by day is the prescribed signal from the International Code of Signals and also four long blasts for tankers and three long blasts for all other vessels. It is advisable to notify the pilotage office 48 hours and 24 hours prior to arrival.

The Promar pilots can be contacted, as follows:

1. VHF: VHF channels 11 and 16
2. Telephone: 57-5-664-4648  
57-5-660-0655  
57-5-664-70666
3. Web site: <http://www.promarpilots.com>

The CMS Cartagena pilots can be contacted, as follows:

1. VHF: VHF channels 11 and 16
2. Telephone: 57-5-645-9743  
57-312-659-9806 (mobile)
3. E-mail: [info@cartagenamaritime.com](mailto:info@cartagenamaritime.com)  
[manager@cartagenamaritime.com](mailto:manager@cartagenamaritime.com)
4. Web site: <http://www.cartagenamaritime.com>

**Regulations.**—Vessels should not pass one another in Boca Chica. Vessels entering the harbor should give way to vessels leaving the harbor.

**Anchorage.**—There is good anchorage in the outer harbor, in a depth of 27m, mud and good holding ground, SW of Punta Castillo Grande. In the inner harbor there is anchorage, in depths of 14 to 16.5m, mud, about 0.3 mile SW of the W pier. A mooring buoy is located near the center of the anchorage area S of Castillo Grande. A restricted anchorage for naval vessels is situated E of the naval base and N of Punta Castillo Grande.

There are additional specialized anchorage areas for tankers

and vessels using Mamonal Port. Tankers will use Anchorage A centered about 1000m E of the Mamonal pier head. Additional anchorage is centered about 3000m E of Isla Abanco. These areas can best be seen on the chart.

**Caution.**—A restricted area, reserved for naval operations of the Colombian Navy, lies in the SW approach to Bahia de Cartagena and may best be seen on the chart. Mariners are requested to navigate with care and to stay clear of the restricted area.

Boca Chica, the entrance channel, accommodates one-way traffic only; outbound vessels have the right of way.

An obstruction, with a depth of 1.2m, lies near the center of Bahia de Cartagena, about 2 miles ENE of Isla Draga and is marked by a lighted buoy.

It has been reported that during the summer months, thunder cell activity can generate winds strong enough to have vessels drag their anchors in the anchorage.

Cartagena—Berth Information				
Berth	Length	Depth alongside	Draft	Remarks
<b>Manga Terminal Maritimo (SPRC)</b>				
No. 1	200m	6.1m	5.7m	Cruise vessels containers, dry bulk, general cargo, and ro-ro automobiles.
No. 2	202m	10.9m	10.6m	Cruise vessels containers, dry bulk, general cargo, and ro-ro. Dolphins lie 45m and 130m from pier.
No. 3	182m	10.9m	10.6m	Cruise vessels containers, dry bulk, and general cargo. Dolphins lie 45m and 130m from pier.
No. 4	130m	8.8m	8.5m	Cruise vessels containers, dry bulk, and general cargo.
No. 5	202m	11.8m	11.5m	Cruise vessels containers, dry bulk, general cargo, and ro-ro at pier's end.
No. 6	184m	11.8m	11.5m	Cruise vessels containers, dry bulk, general cargo, and ro-ro at pier's end.
No. 7	270m	13.4m	13.1m	Containers, dry bulk, project, general cargo, and automobiles.
No. 8	270m	13.7m	13.1m	Containers, dry bulk, project, general cargo, and automobiles.
No. 9	—	13.7m	13.1	Containers, dry bulk, project, general cargo, and automobiles.
<b>Contecar (Terminal de Contenedores de Cartagena S.A.)</b>				
Main Quay	700m	13.5m	—	Containers, bulk cargo, and new vehicles.
Floating Mooring Dock	190m	—	—	Bulk carriers, ro-ro, and general cargo.
<b>Terminal Martimo Muelle el Bosque SA, Cartagena (Isla Diabolo)</b>				
NW Wharf	440m	11.0m	—	Containers and bulk carriers.
SW Wharf	370m	—	—	Containers, project, and bulk carriers.
NE Wharf	225m	9.3m	—	Containers, project, and bulk carriers.

Cartagena—Berth Information				
Berth	Length	Depth alongside	Draft	Remarks
<b>Abocol Terminal</b>				
No. 1	200m	6.0m	—	Discharging fertilizer.
<b>Bavaria Barley Terminal</b>				
No. 1	170m	9.7m	—	Maximum vessel size of 31,000 dwt.
<b>Puerto de Mamonal Terminal</b>				
Main Quay	300m	11.2m	—	Coal, bulk, heavy lift, and project cargo.
<b>Colcinker Coal Terminal</b>				
No. 1	380m	11.4m	—	Coal and cement.
<b>Tanker Berths</b>				
Dow	152m	8.2m	—	Wooden pier with platform and dolphins. Vessels enter during daylight hours only.
Colterminals	180m	8.5m	—	Chemicals,
Dexton	150m	8.3m	—	Two dolphins.
LPG	110m	5.0m	—	LPG.
Petroquimica	70m	7.6	7.3m	Maximum vessel loa of 91m.
(Mamanol) Eco Petrolo Refinery Terminla	260m	14.0m	10.9m	Maximum vessel size of 85,000dwt.
Eco Nestor Pine-da Terminal	260m	10.9m	—	
Algranel Terminal	180m	7.9m	—	

### Cartagena to Golfo de Uraba

**4.17** Between Punta Canoas and Punta Caribana, 143 miles SW, the coast extends S for 70 miles to the small port of Covenas, in the S part of Golfo de Morrosquillo. It then extends for 25 miles in a general W direction and continues S for an additional 64 miles. This coast presents a varied aspect of high, steep land, narrow coastal plains, low shores covered with mangroves, and prominent hilly landmarks. There are several bays and inlets off this section of coast, the most important being Bahía de Cartagena, in which lies the port of Cartagena. There are numerous small towns and villages along this stretch of coast, but the aids to navigation are sparse.

**Islas del Rosario** (10°11'N., 75°45'W.) consist of several islands standing on the detached banks that extend up to 9.5 miles W through points lying 6.3 miles NW from Punta Baru. Isla Tesoro, marked by a light, the northernmost island of the group, is small, sandy, and surrounded by foul ground which extends up to about 0.8 mile offshore. A bank, with a least depth of 5.5m, lies with its shallowest part about 1.8 miles NNE of Isla Tesoro.

Isla del Rosario, the southernmost island of the group, lies 5 miles W of Punta Baru, is marked by a light, and is covered with palm trees. Isla Grande, the largest of the group, is low and lies 2.3 miles ENE of Isla del Rosario.

The depths between the islands are very irregular and there

are many rocks and reefs. The outermost bank lies 3.3 miles W of Isla del Rosario and has a least depth of 11.6m.

**Regulations.**—A national marine park called Corales del Rosario encompasses the waters surrounding Isla del Rosario, Banjo Tortuquilla, Islas San Bernardo, and the waters between them.

Ships, barges, fishing vessels, and major coastal craft are forbidden to sail through the channels between Isla Arena, Punta Baru, and Isla Grande.

**Caution.**—These banks, as well as Bajío Tortuga, described below in paragraph 4.18, constitute a danger in the S approach to Bahía de Cartagena and should be given a wide berth.

The channel between and inside the islands and shoals should not be attempted without local knowledge.

Depths in the vicinity of Islas del Rosario, Bajío Tortuga, and W of Isla Baru may be less than charted.

A dangerous obstruction was reported (2003) to lie about 7.5 miles W of Isla Rosario.

**4.18 Bajío Tortuga** (10°05'N., 75°52'W.), with depths of 4.6 to 18.3m, lies between 3 miles and 9.5 miles SW of Isla del Rosario.

Islas San Bernardo are a group of low rocks, wooded cays, and shoal banks that extend up to 13.5 miles W through about 14.5 miles NW from Punta San Bernardo (9°42'N., 75°42'W.). Isla Tintipan, the northernmost cay of the group and the larg-



est, lies 9.3 miles NW of Punta San Bernardo. Isla Ceycen, the southernmost cay, lies 9.8 miles W of the same point and is marked by a light.

Canal Salamanquilla is a narrow navigable channel, with depths of 20.1m, between the coastal bank extending N from Punta San Bernardo and the bank surrounding the E cay of the group 3.3 miles NW of the point. Another channel, about 1 mile wide and with a least depth of 29.3m, lies between the latter bank and the shoals surrounding the main group of cays.

Between Punta Baru and Punta San Bernardo, a low sandy point, about 26 miles S, the coast recedes about 9 miles NE to form Bahía de Barbacoas, about 7 miles E. This bay has no commercial importance to shipping.

**Golfo De Morrosquillo** (9°35'N., 75°40'W.) recedes about 8 to 10 miles E between Punta San Bernardo and Punta Mestizos, 7 miles SSW. The low coast is fringed by mangroves and wooded swamps. A conspicuous tank and a church stand in the town of Tolu, 12.5 miles SE of Punta San Bernardo; several small jetty walls, which are radar conspicuous, extend a short distance from the beach just in front of the town.

**Roca Morrosquillo** (9°36'N., 76°00'W.), a coral shoal consisting of two heads, one with a depth of 9.1m, the other, located 0.3 mile N, with a depth of 21m, is marked by a lighted buoy and a racon. The shoal lies in the approaches to Covenas Offshore Oil Terminal.

**4.19 Covenas** (9°25'N., 75°41'W.) (World Port Index No. 11900), an oil-loading port, stands on the S side of Golfo de Morrosquillo. A water tank in the village is a good landmark. A private pier restricted to the Covenas oil terminal support fleet, 501m in length and 7.9m alongside, is located E of the tank farm.



Covenas Tank Farm

**Pilotage.**—Pilotage is compulsory. A docking master boards vessels from a tug/pilot boat and leaves the dock on sighting the vessel. The pilot embarks about 2.5 miles NE of Buoy TLU-3, which is marked by a light with a racon, or at the anchorage. An ETA should be sent 72 hours, 48 hours, and 24 hours in advance. Mooring is limited to daylight hours; however, unmooring can be undertaken at any time. A compulsory arrival safety inspection will be conducted by the cargo loading master. VHF contact for pilots and the terminal on channels 16, 20, and 84. Channel 16 is monitored 24 hours. Vessels should

establish contact with Covenas Port control when within 30 nm. All vessels loading at Covenas Terminal must notify 72, 48, and 24 hours prior to arrival.

**Anchorage.**—Vessels awaiting customs and quarantine inspection should anchor in the quarantine anchorage established as best seen on the chart. After being cleared for entry, vessels may proceed E to the designated anchorage area, as shown on the chart, and anchor, in depths of 30 to 36m, mud. Strong SE winds prevail in Golfo de Morrosquillo during the month of December.

**Caution.**—Anchorage and all other bottom activity is prohibited in the area spanning Punta Bolívar and Punta de Piedras, extending in a NW direction for a distance of about 10 miles from the pier head. Submarine pipelines have been laid in this area for the purpose of cargo transfer. Reference should be made to the chart. A large artificial reef is reported (2010) in the SE basin between Covenas and Tolu, which lies between the 10 and 20m depth curve and close SW of the charted anchorage area near Tolu.

**4.20 Covenas Offshore Tanker Terminal** (9°31.7'N., 75°47.2'W.) (World Port Index No. 11901), lying NW of Puerto Covenas, consists of an SPM. It is situated about 9.8 miles NW of Covenas. A Tanker Loading Unit (TLU), consisting of an SPM, is moored 6.5 miles NNW of Covenas. Two more units are moored 7.8 miles NW of Covenas.

Tankers may berth by day or at night. At the SPM, vessels are limited to 180,000 dwt, a maximum length of 300m, and a maximum draft of 35m. They are also limited to a minimum size of 55,000 dwt, and a minimum length of 220m. At the TLU, vessels are limited to a maximum length of 300m and a maximum draft of 25m. TLU-1 has a maximum draft of 17m and a depth of 25m. TLU-2 has a maximum draft of 17.3m and a 28m berth. TLU-3 has a maximum draft of 17m.

**Pilotage.**—Pilotage is as previously described in the section covering Covenas in paragraph 4.19.

**Regulations.**—Vessels are warned that they risk prosecution if they anchor, travel, or carry out other activities affecting the sea bed within the restricted areas. Such areas, which may best be seen on the chart, are situated in the vicinity of submarine pipelines.

**Anchorage.**—Anchorage areas were previously described in the discussion for Covenas in paragraph 4.19.

**4.21 Bahía de Cispatá** (Bahía Zispata) (9°25'N., 75°47'W.), with the Rio Sinu flowing into its head, lies between Punta Mestizos and Punta Bello, about 3.4 miles E. A tall prominent stack stands in the ruins of a village on the SE side of the bay. Small craft, with the aid of a pilot from Cartagena, can navigate several miles up the river. It was reported that depths of 4.6m, or less than charted, lie within the 10m curve in Bahía de Cispatá.

Between Punta Mestizos and Punta Piedras, 18 miles WSW, the coast is low and fringed by mangroves. The 10m curve lies up to 4 miles offshore.

**Isla Fuerte** (9°23'N., 76°11'W.), a low, wooded islet, lies about 6.5 miles WNW of Punta Piedras and is surrounded by foul ground that extends up to 2.5 miles from the S side and nearly 1.5 miles from its W side. The islet is difficult to distinguish when approaching from the W. A village stands on its S



**Covenas Tanker Loading Unit (TLU-2)**

side. A light is shown from the island.

Bushnell Shoal, with a least depth of 11.9m, lies about 9.5 miles WNW of Isla Fuerte. In addition to the above dangers, there are several detached depths of less than 18m lying seaward of the 20m curve.

**4.22 Punta Piedra** (9°20'N., 76°05'W.) is the extremity of a bold headland which extends SW for 3 miles and terminates at Punta de La Rada.

Punta Broqueles, a rocky projection fringed by a reef extending about 0.3 mile seaward, lies about 8 miles SW of Punta Piedra. Bajío Toro, with a least depth of 1.2m, lies 1.3 miles N of the point. Farallon, a group of rocks, up to 5m high, lies 1.8 miles SW of the point. Two isolated depths of at least 6m lie 6 miles SW of the point.

Cerro Tortugon, a 208m high, prominent, conical hill, stands close to the coast, 13 miles SSW of Punta Broqueles. Yuca, a village with a conspicuous white church, is situated on the coast 2.5 miles N of Cerro Tortugon.

**Isla Tortuguilla** (9°02'N., 76°20'W.), a small wooded islet, lies 5 miles W of Cerro Tortugon. Depths of less than 9m lie within 0.8 mile of the islet. A light is shown from the NW extremity of the island.

**Punta Arboletes** (8°53'N., 76°26'W.), a prominent low wooded point, lies 14 miles SW of Cerro Tortugon. Cerro Maconda, a prominent hill, stands 5 miles E of the point.

**Punta San Juan** (8°48'N., 76°31'W.), conspicuous from the NE and SW, stands 7 miles SW of Punta Arboletes. A village stands close N of Punta San Juan.

**Punta Sabanilla** (8°44'N., 76°38'W.), a low point, is located

15 miles SW of Punta Arboletes. Cerros de Sabanillas, a group of hills, rises 2.5 miles SSE of the point. The highest hill rises to an elevation of 248m. A bank, with unknown depths, lies about 5 miles W of Punta Sabanilla. Punta Giganton, a low and sandy point, lies 1.3 miles SSW of Punta Sabanilla.

## Golfo de Uraba

**4.23 Punta Caribana** (8°37'N., 76°53'W.), the E entrance point of Golfo de Uraba, is low, wooded, and marked by a light. Cerro Aguila stands close within the point and is an excellent landmark. Foul ground, with some rocks awash, extends 3.8 miles NNW from the point. The 20m curve lies 9 miles N and 4 miles W of the point.

The coast between Punta Caribana and Cabo Tiburon, 28 miles W, recedes 45 miles S to form Golfo de Uraba. The shores of the gulf are generally low, heavily-wooded, and swampy on the E, S, and SW sides, and hilly, with coves and sandy beaches, on the NW side. The coastline was reported (1985) to have extended seaward on both the E and W shores of Golfo de Uraba, especially between 8°00'N and 8°10'N. Loss of depth due to sedimentation from the mouth of the Atrato River has been found in Golfo de Uraba, SE of Isla Los Muertos. Serrania del Darien is a mountain range backing the coastal plain on the W side about 12 to 15 miles inland. Several rivers discharge into the gulf. The delta of the Rio Atrato extends into the gulf from the SW side, forming a bight at its head called Bahia Colombia.

**Winds—Weather.**—Between Punta Caiman and Punta Revesa, a current has been observed to set N at a velocity of up to 2 knots.

Chocosanas is the name of S storms which are very common from June to October. They occur most frequently from 2200 to 2400 and are preceded by light N winds and general lightning around the horizon. The wind gradually shifts from N to S increasing in force. The main storm center lasts about 30 minutes, with winds attaining nearly hurricane force. It is accompanied by heavy rain and electrical disturbances, and as much as 160mm of rain may fall during one storm.

**4.24** From Punta Caribana, the low coast extends about 5.5 miles SW to Punta Arenas del Norte (8°33'N., 76°56'W.), which is the W end of a sandy, steep-to peninsula which is marked by a light. A stranded wreck lies 0.3 mile NW of Punta Arenas del Norte. It has been reported (1994) that this wreck is no longer visible.

Between Punta Arenas del Norte and Punta Caiman (8°16'N., 76°46'W.), a low sandy point 19.5 miles SE, the coast recedes 4.5 miles SE and is low, with several hills near the shore. Punta Uraba, a rocky bluff with a village on it, is located midway between the two points.

From Punta Caiman, the coast extends S for 12.8 miles to Punta las Vacas (8°04'N., 76°44'W.), the N entrance point of Bahia Turbo. The coast between the latter point and a position lying 5.5 miles N was reported (1983) to be extending W, with considerable reef build up. It also was reported that a point has been formed at this position, and the Rio Turbo flows out at this point.

**Depths—Limitations.**—There are general depths of 18 to 64m in Bahia Colombia. The 10m curve lies up to 1.8 miles off

the E shore of the gulf and up to 1.5 miles off the W shore. In the vicinity of the Rio Atrato, the 10m curve lies up to 2.3 miles offshore; in the W part of the bay, the 10m curve lies up to 3 miles offshore.

There are several small islets along the W side of the gulf, but they all lie within the 10m curve.

**Turbo** (8°06'N., 76°43'W.) (World Port Index No. 11880) is situated 1.5 miles NE of Punta las Vacas.

**Pilotage.**—Pilotage is compulsory in Bahía Colombia. The pilot embarks at the anchorage W of Punta las Vacas and takes the vessel to the appropriate loading anchorage in the bay. The vessel's ETA messages may be sent through Baranquilla radio. There are no port facilities. Ships load from lighters using mechanical conveyors.

**Anchorage.**—Vessels anchor about 2 miles W of Punta las Vacas, in a depth of 13m, to await the boarding officials. There are two additional charted anchorages in the S and SW parts of the bay which can best be seen on the chart. Quarantine anchorage is situated about 2.25 SSW of Punta las Vacas.

**4.25** Between Cabo Tiburon, the W entrance point of Golfo de Uraba, and Punta Yerbasa, at the N end of the delta of the Rio Atrato, 35 miles SE, the W coast of Golfo de Uraba is rocky, rugged, and backed by heavily-wooded slopes. There are many bluffs and some sandy beaches and coves. Several islets and rocks lie within 1.5 miles offshore.

**Acandi** (8°31'N., 77°16'W.) lies at the mouth of the Rio Acandi, 11 miles SE of Cabo Tiburon.



Acandi from W

Terron de Azucar is an excellent landmark located between Cabo Tiburon and Acandi. It is a precipitous dark rock lying 1.3 miles offshore, about midway between the two positions. A detached 6.8m depth lies 0.3 mile NNW of the rock. A rocky ridge, over which the sea breaks in heavy weather, connects Terron de Azucar with the coast.

Between Acandi and Punta de La Goleta, a steep rocky point 8 miles SE, there is a sandy beach that is broken by the hills extending to the shore nearly 2 miles SE of the town. Two large rocks, 7m high, stand 0.5 mile NNE of the point.

From Punta de La Goleta, the coast resumes its rugged and bold character and continues 13.3 miles SE to Playa Tarena, a

low sandy beach that extends an additional 5.5 miles to Punta Yerbasa. Several rocks and islets lie within 1.5 miles of this coast.

**Isla Napu** (8°25'N., 77°07'W.), a steep and rocky island, covered with brush and small trees, lies 2.8 miles ESE of Punta de La Goleta.

The delta of the Rio Atrato, one of the largest rivers in South America, lies between the vicinity of Punta Revesa (Punta Yerbasa) (8°16'N., 76°57'W.) and a position 15 miles S. This large area is mangrove-covered swampy land extending up to 6.5 miles E of the general trend of the coast. Isla Los Muertos (8°08'N., 76°50'W.), a small, wooded islet lying 10.5 miles SE of Punta Yerbasa, is the easternmost feature of the delta and is the only solid ground in the whole area. Shoaling was reported (1982) E of Isla Los Muertos. Shoaling was also reported off a salient point located 6.8 miles SSW of the island. The river has several principal mouths, the largest being the Boca Tarena, 2 miles W of Punta Revesa.

## Golfo de Uraba to the Panama Canal

**4.26 Cabo Tiburon** (8°41'N., 77°22'W.), the W entrance point of Golfo de Uraba, is a bold steep-to promontory, which rises to a height of 123m a short distance inland. On its NW extremity are two concrete beacons which mark the boundary between Colombia and Panama. The seaward beacon stands on a pinnacle rock. A light, with a racon, is shown from the cape.

Between Cabo Tiburon and Punta Carreto, 12 miles NW, the coast recedes about 3.5 miles W then NW to form a bight in which are several small coves. There are few dangers here. With the exception of a 10m shoal and a steep-to 19m coral bank lying 1.5 and 7.5 miles NE of Punta Carreto, respectively, the 20m curve follows the trend of the coast at 1 mile offshore. In heavy weather, the sea breaks on this shoal.

Puerto Obaldia, a small cove in which there is a village, lies 4 miles W of Cabo Tiburon. The intervening coast is rather steep-to and rocky, with steep heavily-wooded hills rising inland. A prominent rock lies 1 mile N of the E entrance point of the cove.

**4.27 Puerto Perme** (8°45'N., 77°32'W.), a narrow cove, lies 8 miles NW of Puerto Obaldia. A village is situated 1 mile SSW of Puerto Perme. The port is abandoned, but anchorage can be taken, in a depth of 9.7m, in the center of the cove.

Puerto Carreto, a small cove, lies close W of Punta Carreto. Two steep-to rocky patches lie 2.5 miles N of Punta Carreto and break with fresh breezes. There are general depths of 5.5 to 16.5m in the cove. A small village stands near the mouth of a river on the W side of the cove.

Between Puerto Carreto and Punta Brava, 39.5 miles NW, the coast is fronted by many dangers which extend up to 5 miles offshore. Some of the projecting headlands and islets make good landmarks. Punta Escoces, a remarkable headland, rises to a 177m summit about 5.5 miles NW of Puerto Carreto.

Between Punta Escoces and Punta Sasardi, another peninsula 9 miles NW, there are several roadsteads which provide anchorage. Islas Sasardi, a group of high islets, lie on the coastal bank within 2.5 miles of the coast between the above points. Bahía Caledonia lies W of Ilha de Oro, a high islet 3.8 miles NW of Punta Escoces. Bahía Sasardi lies SW of Punta Sasardi.

The approaches to these roadsteads are intricate.

From Punta Sasardi, the coast extends about 25 miles NW to Punta Brava. About midway between these points, a peninsula projects NW from the coast.

All of the known dangers lie up to 4 miles offshore between Punta Sasardi and Punta Brava. Isla de Pinos, 122m high, lies 0.3 mile offshore about 2.5 miles NW of Punta Sasardi. Isla Pajaros, a low islet surrounded by reefs, lies 2.5 miles farther NW. It was reported that Isla Pajaros is an outstanding landmark as it is densely wooded, with coconut trees about 24m high.

**Caution.**—Much of the coastal area between Cabo Tiburon and Punta Brava has not been surveyed. Extreme caution should be used in approaching this stretch of coast.

**4.28** Between **Punta Brava** (9°15'N., 78°03'W.) and **Punta Mandinga** (9°28'N., 78°58'W.), 57 miles WNW, the coast is fronted by the Archipiélago De San Blas, a closely bordered group of cays, reefs, and banks lying within 10 miles of the coast. The village of Rio Diablo stands on two small islands close offshore 34 miles WNW of Punta Brava. Depths in the vicinity are reported to be less than charted.

There are a number of navigable channels in the Archipiélago de San Blas, and vessels with local knowledge have little trouble navigating them. The E approach to Golfo de San Blas is made through this group via Canal Caobo (9°33'N., 78°40'W.) and Canal Mayflower (9°33'N., 78°45'W.).

**Golfo de San Blas** (9°30'N., 79°00'W.) lies between Punta San Blas and Punta Mandinga, and is entered from the N by Canal de San Blas, which leads in adequate depths 2.5 miles E of Punta San Blas. There are numerous detached dangers in the S and W parts of the gulf. Numerous creeks and rivers discharge into this gulf, but their entrances are obstructed by bars. The N shore of the gulf is swampy and fringed with mangroves. The S shore is low, but E of Punta Mandinga the high land approaches the coast.

Islas Robeson, a group of small islands, lie in the SW part of the Golfo de San Blas. Between these islands and the W side of the gulf lies Bajo Alden (9°28'N., 79°03'W.). A channel, which is not buoyed, leads through Bajo Alden to a roadstead off the SW shore of the gulf. The entrance of this channel lies 1.3 miles WNW of the westernmost island of Islas Ammen. The channel is about 270m wide and has depths of 18 to 35m. Caution should be exercised to avoid the 1.5m depth lying 1.5 miles W of the westernmost of the Islas Ammen.

An man-made stone and coral island stands on a reef 0.3 mile SW of Sail Rock (9°33'N., 78°57'W.), on the W side of Canal de San Blas. This island shows clearly on radar. A stranded wreck lies close E of Sail Rock.

Isla Porvenir lies 0.3 mile NNW of Sail Rock. A government station compound, with two conspicuous buff-colored buildings and several lesser structures, stands on the W side of the islet. All vessels transiting in and out of Golfo de San Blas must contact this station.

**Caution.**—There are no charted navigation aids in the Golfo de San Blas. Extreme caution is advised when navigating in the area.

**4.29** **Punta San Blas** (9°34'N., 78°58'W.) has a low extremity. A hill, 46m high, rises 0.5 mile NW of its E extremity.

A 61m hill, which is the highest of a group of four hills, rises 1.5 miles WSW of the E extremity. A conspicuous tower stands 0.8 mile SW of the extremity.

Between Punta San Blas and Punta Macolla, (9°36'N., 79°26'W.), 28 miles W, the coast is low and wooded, but in the vicinity of the latter point, the mountains approach the coast. Two conspicuous peaks stand here and rise to high elevations. Several villages stand along this stretch of coast.

**Piedra de Culebra** (9°34'N., 79°13'W.) lies 0.5 mile N of the extremity of a projecting peninsula near Palmira. The islet is easily recognized and shows up dark against the mainland.

The depths off this section of coast are very irregular; banks with depths of 9m are found up to 6 miles offshore. A coral area lies, awash, about 2 miles offshore, about 9 miles WNW of Punta San Blas; depths of 3.7 to 5.6m lie within 0.8 mile NNW of the coral area. Several small islets lie within 0.5 mile of the shore.

Punta Macolla is bold, high, and easily identified. From the W, it appears as a dark bluff.

**Punta Pescador** (9°36'N., 79°28'W.) is a reef-fringed point close W of Punta Macolla. La Providencia Shoal, a bank with a least depth of 8m, lies 3 miles N of the point.

**4.30** **Bahia San Cristobal** (9°37'N., 79°30'W.), entered between Punta Pescador and Punta Manzanillo, 5 miles WNW, is divided into several small bights. There are a number of dangers in the bay, the outermost being some rocks, nearly awash, 2.3 miles W of Punta Pescador and some bare black rocks, the highest about 1.4m high, lying 1.8 miles SE of Punta Manzanillo. Depths of 9 to 18m exist within the bay.

**Bahia Nombre de Dios** (9°35'N., 79°28'W.), a small shallow bay with depths of 1.8 to 8.2m, lies about 1 mile SW of Punta Pescador. A narrow channel, with a least depth of 5.8m, leads S into the bay. A village is situated on the S side of the bay.

A pier, about 180m long, is situated on the W side of the entrance to Bahia Nombre de Dios and has a depth of 6.1m alongside its head.

Anchorage can be taken, in a depth of 12m, within Rada Playa de Damas, close N of the entrance to Bahia Nombre de Dios.

**Punta Manzanillo** (9°38'N., 79°33'W.), the N extremity of the coast of Panama, is a high, precipitous projection with two conical hillocks resembling a saddle. It is the termination of a mountain ridge that extends along the coast to the mouth of the Rio Piedras.

**Los Magotes De Manzanillo** (9°38'N., 79°32'W.) consists of two islets and some rocks lying within 1 mile NE of Punta Manzanillo. Mogote de Afuera, the outer islet, has a tree on its summit and is 11m high. Magote de Adentro, the inner islet, is wooded, round topped, and 41m high.

**4.31** Bajos Mafu, with a depth less than 1.8m, lies about 0.3 mile NW of Punta Manzanilla within a bank with depths of less than 18m. The sea generally breaks over these rocks.

**Isla Grande** (9°38'N., 79°34'W.), a high palm tree-covered island, lies 1 mile W of Punta Manzanillo. Foul ground extends along all except its NE side. Isla Grande, marked by a light, is reported to be radar conspicuous.

Cayo Tambor, a small flat-topped islet, lies 0.3 mile NNW

of Isla Grande and is connected to it by reefs, some of which are above-water. The islet gives the appearance of an inverted pan from the NE. Its N end is higher than the S end.

A confused sea and tide rips are nearly always found in the vicinity of the islet.

Between Punta Manzanillo and Punta Cacique, a high steep-to projection backed by twin projections, the coast is indented by several small bays and is fronted by a number of islands and shoals.

**4.32 Puerto Garote** (9°36'N., 79°35'W.), a small harbor entered 0.5 mile W of Isla Grande, is formed by the coast and several off-lying islands. The narrow entrance has depths of 11 to 22m. The inlet leading into the harbor has a depth of 10.3m and there is a depth of 6.1m in the center of the harbor. A small pier extends from the shore of the harbor.

Anchorage can be taken in this harbor by one moderate-size vessel.

**La Lavandera** (9°38'N., 79°36'W.), two rocks with a least depth of 0.9m, lie in the approach to Puerto Garote, 1.3 miles W of the W end of Isla Grande. The sea almost always breaks on La Lavandera; however, when the sea is very smooth, there may not be a break for 15 to 20 minutes.

Las Farallones, a group of rocks, some submerged, lie up to 2 miles offshore NNW of Punta Cacique. Farallon Sucio, 24m high, is the largest of these rocks and displays a light. From a distance, the rocks appear as one and are easily discernible by their bare whiteness. Farallon Sucio is reported to be radar prominent.

The coast between Punta Cacique and Punta Mantilla, about 4.8 miles SW, is high and indented by several bays. With the exception of the coastal bank that extends up to 1 mile offshore, about midway between the above points and on which are the two conspicuous islets of Duarte, the coast is fairly steep-to, the 20m curve lying up to about 0.2 mile offshore.

**Punta Esperanza** (9°37'N., 79°38'W.), located 1 mile WSW of Punta Cacique, and Punta Sabanilla, about 1.5 miles further WSW, are both cliffy.

Piedras La Gallina, two dangerous rocks, lie close together 0.1 mile offshore and 0.5 mile NE of Punta Mantilla. Isla Drake, a small islet 21m high, lies 0.1 mile offshore and 0.3 mile SW of Punta Mantilla. Its W extremity appears as a detached rock. Bajo Salmedina, a coral reef on which the sea breaks, lies on a bank located 0.3 mile WSW of Punta Mantilla.

**4.33 Portobelo** (9°33'N., 79°40'W.), a good harbor of refuge, is entered between Iron Castle Point and Punta Coco, 0.3 mile S. The depths in this bay decrease from 23.8 to 25.6m in the entrance to about 11m in the inner part WNW of the town.

The N and S sides of the harbor rise to hills, 182 to 396m high, which provide shelter. The head of the harbor is swampy. Depths may be less than charted because of silting. A conspicuous church, with a large red roof and a small white tower, stands in Portobelo. Deep-draft vessels can take sheltered anchorage in Portobelo.

Between Punta Coco and Galeta Point, the N extremity of Galeta Island, 14.5 miles SW, the coast extends irregularly and is high for the first 6.5 miles as far as the mouth of the Rio Piedras (9°27'N., 79°44'W.). It then gradually diminishes in height

and becomes low and fringed by mangroves.

**Caution.**—Vessels without local knowledge should stay at least 3 miles offshore and even further at night in this area.

Isla Los Mogotes lie close SW of Punta Coco. The outermost and larger of these islands is 48m high. Punta Gorda, which rises to a height of 47m close S of its extremity, lies 4.3 miles SW of Isla Los Mogotes. From Punta Gorda, the coast gradually becomes very low and fringed with mangroves as it trends SW about 6 miles to Cayos Naranjo. Cayos Naranjo are two reef-fringed heavily-wooded islets.

**4.34 Bahía de las Minas** (9°24'N., 79°49'W.) (World Port Index No. 9875), which is encumbered by numerous islands, islets, and reefs, recedes S about 2.5 miles. Several rivers discharge along the shores of the bay. A large refinery is situated on the E shore of Isla Payardi in the SE part of the bay. Tidal variation in the port is less than 0.3m.

**Depths—Limitations.**—For berthing information see the table titled **Bahía de las Minas—Berth Information**.

Bahía de las Minas—Berth Information			
Berth	Length	Depth	Remarks
North Dock	91m	—	Crude oil. A T-shaped jetty with mooring dolphins at either end.
South Dock	91m	11.5m	LPG and crude oil. A T-shaped jetty with mooring dolphins at either end.
Cargo Dock	91m	6.7m	Ro-ro. Vessels with a maximum loa of 180m.
Cement Berth	185m	10.5m	Cement.

**Aspect.**—A stack, which emits a gas flare, is situated near the SE end of Payardi Island. This flare, which has been reported to be visible up to 20 miles seaward, is an excellent landmark.

**Pilotage.**—Pilotage is compulsory. The pilot boards in the vicinity of Approach Lighted Buoy. The pilot may also board near or just inside the breakwater. Vessel entering should radio their ETA at least 24 hours prior to arrival.

The pilots can be contacted on VHF channel 10, 12, 14, or 16.

**Anchorage.**—Vessels awaiting a pilot can anchor to the E of No. 1 Buoy, in a depth of 18m, taking care to avoid an 11m patch lying about 0.8 mile W of the S end of Cayo Naranjo Abajo. Vessels can also anchor WNW of No. 1 Buoy, avoiding a dangerous wreck lying SW of this buoy and marked on the N side by a lighted buoy.

**4.35** The coast between Galeta Point and Punta Margarita, 2 miles SW, is formed by the N and W coasts of Galeta Island and Margarita Island, and the smaller Isla Palma Media (9°24'N., 79°53'W.) which lies between them. Reefs fringe the shores of these three low mangrove-covered islands.

Penas Guapas, on which the sea breaks, lies about 0.8 mile ENE of Galeta Point. A rock, with a depth of 1.8m and which also breaks, lies 0.3 mile N of Galeta Point.

**Caution.**—Vessels without local knowledge should stay at least 3 miles offshore in this area.

Between **Punta Margarita** (9°23'N., 79°53'W.) and Punta Toro, 3.8 miles WSW, the coast recedes 4 miles S to the entrance of the Panama Canal and forms Bahia Limon. The N side of this bay is nearly enclosed by two extensive breakwaters. Bahia Manzanillo, which includes the harbor of Coco Solo, lies in the E part of Bahia Limon. The harbors of Cristobal and Colon lie in Bahia Limon.

Between Punta Toro and Brujas Point, which is described in paragraph 5.2, the coast extends 2.5 miles SW and is fringed by a drying coral reef. The 10m curve extends up to 0.5 mile offshore and the coast is backed by comparatively high wooded land.

### The Panama Canal—Atlantic Approach

**4.36** The Atlantic approach to the Panama Canal leads from the Caribbean Sea and passes through the length of Bahia Limon, which is protected by two breakwaters known, as East Breakwater and West Breakwater, extending across its N end. The 20m curve trends WSW from a position about 2 miles N of Punta Margarita and lies 1 mile N of the breakwater entrance. This entrance is about 0.3 mile wide and lies in the middle of the bay between the seaward ends of the breakwaters. The entrance channel is buoyed according to the IALA Region B system.

**Winds—Weather.**—The climatological year in the canal area is customarily divided into a wet season (April through December) and a dry season (December through April). Average rainfall during the dry season is about 110mm, whereas, that of the wet season is about 1,690mm, with the maximum precipitation occurring during daylight hours in both seasons.

Uniformly high temperature and humidity make the climate oppressive.

### Puerto Cristobal (9°21'N., 79°55'W.)

World Port Index No. 9860

**4.37** Puerto Cristobal is the Atlantic terminus of the Panama Canal. The harbor of Cristobal consists of the dredged area S of Muelle Cristobal and includes the inlet, S of Cristobal, which leads to the old French Canal. Pier 16 lies at the entrance to the French Canal. It is reported (2009) that the pier side 16 potable water supply unit was severely degraded. Three piers extend SW from Muelle Cristobal; a signal station is situated near the head of the westernmost of these piers. There are numerous piers, a dry dock, and a marine railway on the E side of the inlet. The harbor of Puerto Colon occupies a 0.5 mile square area just N of Muelle Cristobal. Several piers and wharves are situated along the shore of the city of Colon. Colon has a large international free trade zone.

**Tides—Currents.**—The greatest variation in range is 0.6m. The range is frequently more affected by the direction of the wind than by any other factor. Fresh NW winds may cause some current setting SE in Bahia Limon.

An E set across the channel outside the entrance is normally encountered. Shallow water effect frequently causes vessels to respond adversely.

**Depths—Limitations.**—From the 20m curve N of the breakwater entrance, the depths gradually decrease to about 13m between the breakwaters, and to a least depth in the dredged entrance channel of 13m. The S part of Bahia Limon is shallow; this area is also used as a spoil area. A shoal area here uncovers. Several wrecks lie in this part of the bay.

Refer to the accompanying table titled **Cristobal—Berthing Information** for specific information regarding the berthing facilities at Cristobal.

Cristobal—Berthing Information					
Dock/Berth	Maximum vessel		Depth alongside	Pier length	Remarks
	LOA	Draft			
6A	295.66m	12.19m	12.5m	313.94m	Passenger and ro-ro vessels
6B		10.97m			
6CD	313.94m	12.19m	12.5m	313.94m	Passenger vessels (see Note)
6E	73.15m	10.06m	12.5m	73.2m	Water
7A	280.42m	12.19m	12.5m	297.78m	Petroleum products, water, and general cargo (see Note)
7B		11.88m			
7CD	304.8m	13.1m	13.5m	304.8m	All types of cargo (see Note)
7E	73.15m	12.19m	12.5m	73.15m	Water
8A	287.12m	12.19m	12.5m	301.75m	Petroleum products, water, and general cargo (see Note)
8B		10.0m			
8C	291.08m	12.0m	12.5m	307.84m	Water (see Note)
8D		11.58m			





Puerto Cristobal

more in their ETA on VHF channel 9.

If requested and at extra expense, pilots will meet vessels outside the breakwaters and will take outbound vessels out through the breakwaters. Vessels should provide a good lee for the pilot boat if boarding a pilot outside the breakwater.

**Regulations.**—All vessels must hoist their designator signals during daylight when approaching and entering Bahia Limon. Vessels so equipped must call the signal station on VHF channel 12. All other vessels may use International Code and flashing light. Vessels shall, until a pilot boards, maintain a continuous watch on VHF channel 12.

Vessels approaching the Panama Canal shall communicate by radio with the Navigation Division not less than 48 hours in advance of arrival.

No vessel may approach within 1 mile of the breakwater entrance until it has identified itself.

**Anchorage.**—During periods of harbor congestion, large deep-draft vessels and/or any vessel so directed may anchor outside the breakwater in the approved area. Vessels will be given a definite time to enter the breakwater, where the vessel will be met by transit pilots and boarding officials. Anchorage Area F at Puerto Cristobal has been resurveyed. Depths are approximately 1.3m less than charted.

Anchorage is prohibited in or near the axis of the dredged channel.

**Caution.**—A submarine telephone cable, which may best be seen on the chart, lies W of the approved anchorage areas. Mariners anchoring W of the approved anchorages should keep clear of this cable. Additional information on the cable can be obtained by contacting the cable landing station at Battery Pratt, which monitors VHF channel 12.

Vessels required to remain underway outside Bahia Limon are cautioned to keep N of the breakwaters until it is clear to



Cristobal—Pier 7 activity (center)

enter.

Mariners are advised that considerable development has taken place at Colon Container Terminal, Manzanillo International Terminal and along the Colon waterfront. Depths less than charted have been reported (2010) throughout the Colon main channel and the Turning Basin.

## The Panama Canal

**4.38** The Panama Canal, a lock-type canal traversing the Isthmus of Panama in a SSE direction for approximately 51 miles, connects Bahia Limon on the Atlantic side with Panama Bay on the Pacific side. The ports of entry for the canal are



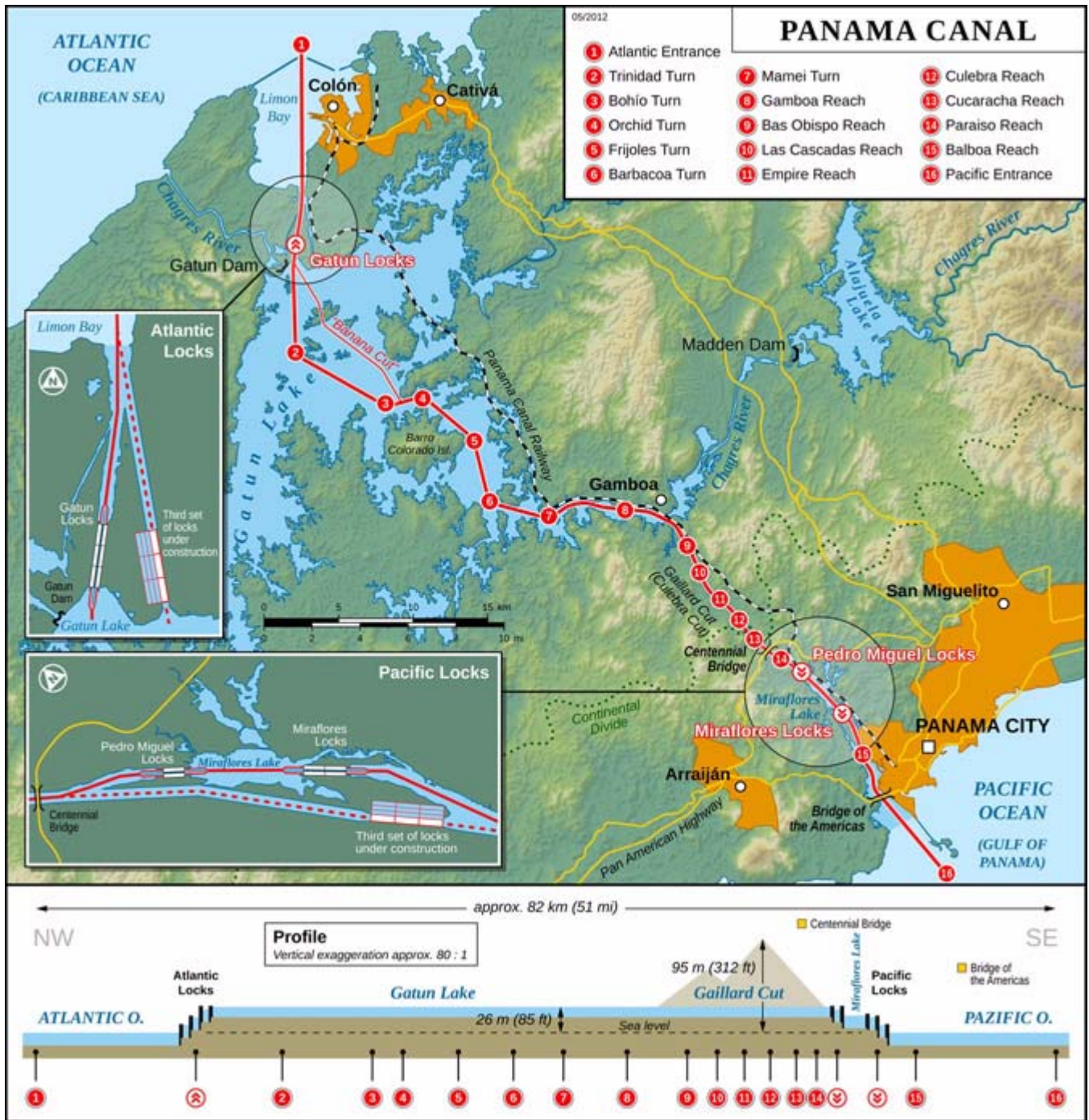

Present and Future Track of the Panama Canal (insets show expansion locks)



**Gatun Lock entering from the Caribbean Sea**

Cristobal, on the Atlantic side, and Balboa, on the Pacific side.

**Panama Canal Authority (ACP) Home Page**

<http://www.pancanal.com>

All ships should be familiar with the Maritime Regulations issued by the Panama Canal Authority. These regulations can be accessed from the Panama Canal Authority (ACP) home page provided at the end of this section. Vessels should also be familiar with the Notices to Shipping section from the Panama Canal Authority (ACP) home page, most notably the Panama Canal Harbor Operations Requirements and the Panama Canal Vessel Requirements, accessed from the Panama Canal Authority (ACP) home page. Vessels should consult these regulations prior to transiting. A brief discussion of some of these regulations and requirements are provided here and a more detailed description of them are provided in Pub. 153, Sailing Directions (Enroute) West Coasts of Mexico and Central America.

See Pub. 153, Sailing Directions (Enroute) West Coasts of Mexico and Central America for more details of the Panama Canal and the port of Balboa and its approaches.

The Panama Canal is largely made possible by the Gatun Lake watershed and the Rio Chagres, which lie about in the

middle of the Isthmus of Panama. The greater part of the canal channel is at the level of Gatun Lake, the surface of which is 25.9m to 26.5m above sea level, varying according to the season of the year.

Gatun Lake is reached by passing through the Gatun Locks. A vessel will pass through a dredged channel, 152m wide and about 6 miles long, leading S from just inside the breakwater entrance to the Gatun Locks.

It is reported (2012) that between sunset and sunrise, all range lights are sectored to minimize light pollution. Consequently, visual fixes will not be possible during this time. It is also reported (2012) that there are little to no visual aids available for navigation through Gatun Lake for nighttime transit.

In transiting the canal, a vessel is raised in three steps, or lockages; first to the level of Gatun Lake through the Gatun Locks, then is subsequently lowered in three steps to sea level on the other side of the isthmus. The flights of locks are in duplicate, enabling vessels to pass in opposite directions simultaneously. The average canal transit time is 12 hours.

The lock gates and valves are electrically operated from a central control station. A vessel is moored to electric towing locomotives which run on tracks on both sides of the lock, pulling the vessel through and keeping it in position.

The entire operation is directed by a lock master on the center wall. All of the canal lock chambers are similar in dimen-

sions and method of operation.

Approaching the canal from the Atlantic side, the tidal flow extends to Gatun Locks, but currents due to their influence alone are slight. Fresh NW winds may cause some current in Limon Bay setting SE toward the harbor berths, and spilling at Gatun Locks causes strong currents for a short time in the channel immediately below the locks.

The Panama Canal is undergoing an extensive expansion program, expected to be completed in the spring of 2015, that will increase the maximum draft, loa, and beam allowable for vessels to transit the canal. The program involves the dredging of a new channel W of the present one and the addition of a new three-step lock on the Atlantic side and another one on the Pacific side. This new channel will accommodate vessels of up to 366m in length, 49m in width, and a maximum draft of 15.2m in TFW (Tropical Fresh Water).

Local authorities should always be contacted to confirm conditions of all aids to navigation and other conditions in the canal. Additional information may be obtained from the website of the Panama Canal Authority.

### Pilotage

Pilotage is compulsory for all vessels in transit through the canal between the Atlantic Entrance from a line starting at Cristobal, passing through Lighted Beacon No. 1 (mole) and Lighted Buoy No. 2, until the Pacific Entrance, a line passing through Lighted Buoy No. 1 and Lighted Buoy No. 2.

The Panama Canal Authority will grant exemptions from compulsory pilotage to certain vessels provided the vessel owners or operators submit a request for this exemption to the Transit Operations Division Executive Manager. All exemptions granted will be valid for 1 year and if a continuation of a granted exemption is needed, a new request must be submitted within 1 month before expiration of the existing exemption. Failure to make the continuation request within 1 month of expiration of the existing exemption will result in a new request having to be submitted.

Vessel categories that are eligible for this exemption are, as follows:

1. Self-propelled vessels up to 38.1m in length.
2. Self-propelled vessels up to 1,000 Panama Canal (PC) gross tons.
3. Self-propelled vessels carrying hazardous cargo (bulk or packaged) up to 500 Panama Canal (PC) gross tons.
4. Self-propelled passenger vessels up to 500 Panama Canal (PC) gross tons.
5. Towboats without tows.

For vessels exempted from compulsory pilotage, permission must be obtained from the Panama Canal Port Captain before vessels commence any movement into or out of the harbor or when shifting berths. A watch must be maintained on VHF channel 12 to receive any further instructions while maneuvering.

Vessels requiring the services of a pilot before entering the breakwater vessels should contact the Cristobal Signal Station to request the pilot while the vessel waits outside the breakwater.

### Regulations

Vessels are required to forward their ETA at least 96 hours in advance to the Traffic Management Unit of the Panama Canal Authority. If there has been a change in ETA by 1 hour or more vessels should advise this to the Traffic Management Unit 12 hours before arrival. See Pub. 153, Sailing Directions (Enroute) West Coasts of Mexico and Central America for details regarding what information needs to be included in the ETA report.

Vessels must also contact the Cristobal Signal Station on VHF channel 12 before arriving 6 miles outside the breakwaters. The Port Entry Coordinator will contact any vessels that have arrived within 6 miles of the breakwater and request their intentions if they have not made contact with the Signal Station by then. The Signal Station will advise vessels of their transit times on VHF channel 12. Pilots will board inside the breakwaters.

The Port Entry Coordinator at the Signal Station must be contacted when arriving or departing the anchorages either inside or outside the breakwaters.

1. All power driven vessels of 300 grt or larger.
2. If carrying one or more passengers, all power driven vessels of 100 grt or larger.
3. All commercial towing vessels 7.93m in length or longer.

All vessels greater than 300 grt or over 20m in length must be equipped with an Automatic Identification System (AIS) transponder that meets the standards set by the International Maritime Organization. Any vessels without this equipment must rent portable AIS units from the Panama Canal Authority.

All vessels underway between the Pacific and Atlantic entrances to the canal are required to continuously monitor VHF channel 13.

If any of the following events occur during canal transit, a report must be made to the Traffic Management Unit:

1. Any accident or other incident which may cause delay or require assistance.
2. Discovery of any defect that may interfere with safe navigation.
3. Anchoring or mooring when visibility falls below 305m.

See Pub. 153, Sailing Directions (Enroute) West Coasts of Mexico and Central America for further details regarding additional regulations and requirements of vessels transiting through the Panama Canal.

### Contact Information

The various agencies of the Panama Canal authorities can be contacted, as follows:

1. Panama Canal Authority and Marine Bureau
  - a. VHF: VHF channels 12, 13, and 16
  - b. Telephone: 507-272-4500
  - c. Facsimile: 507-272-3892
2. Traffic Management Unit:
  - a. Telephone: 507-272-4201
  - b. Facsimile: 507-272-3976
  - c. E-mail: [eta@pancanal.com](mailto:eta@pancanal.com)

3. Transit Operations Division:
  - a. Telephone: 507-272-4211
  - b. Facsimile: 507-272-7688
4. Dangerous Cargo Information:
  - a. Telephone: 507-272-4219  
507-272-4213
  - b. Facsimile: 507-272-3015
  - c. E-mail: [opts@pancanal.com](mailto:opts@pancanal.com)

### **Anchorage**

There are many designated anchorage areas both outside and

inside the breakwaters, all best seen on the chart.

### **Caution**

It is reported (2012) that the light strength for lighted buoys marking dredging operations found throughout the canal is weak so a sharp lookout should be maintained for identification of these hazards between sunset and sunrise.

Mariners must be alert for frequent vessel movements not only to and from the canal, but also to and from anchorages inside and outside of the breakwaters.

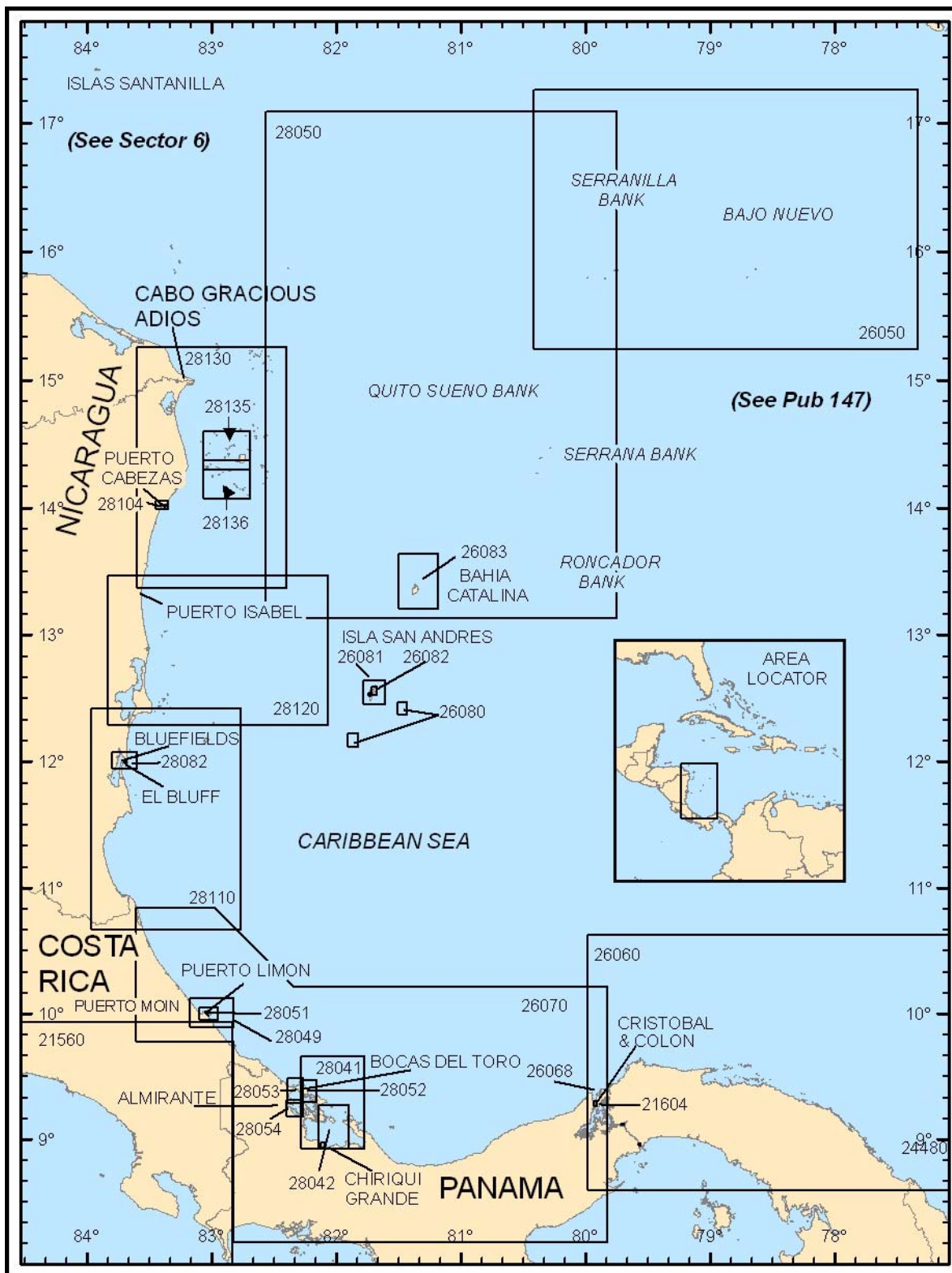

Additional chart coverage may be found in NGA/DLIS Catalog of Maps, Charts, and Related Products (Unlimited Distribution).  
**SECTOR 5 — CHART INFORMATION**

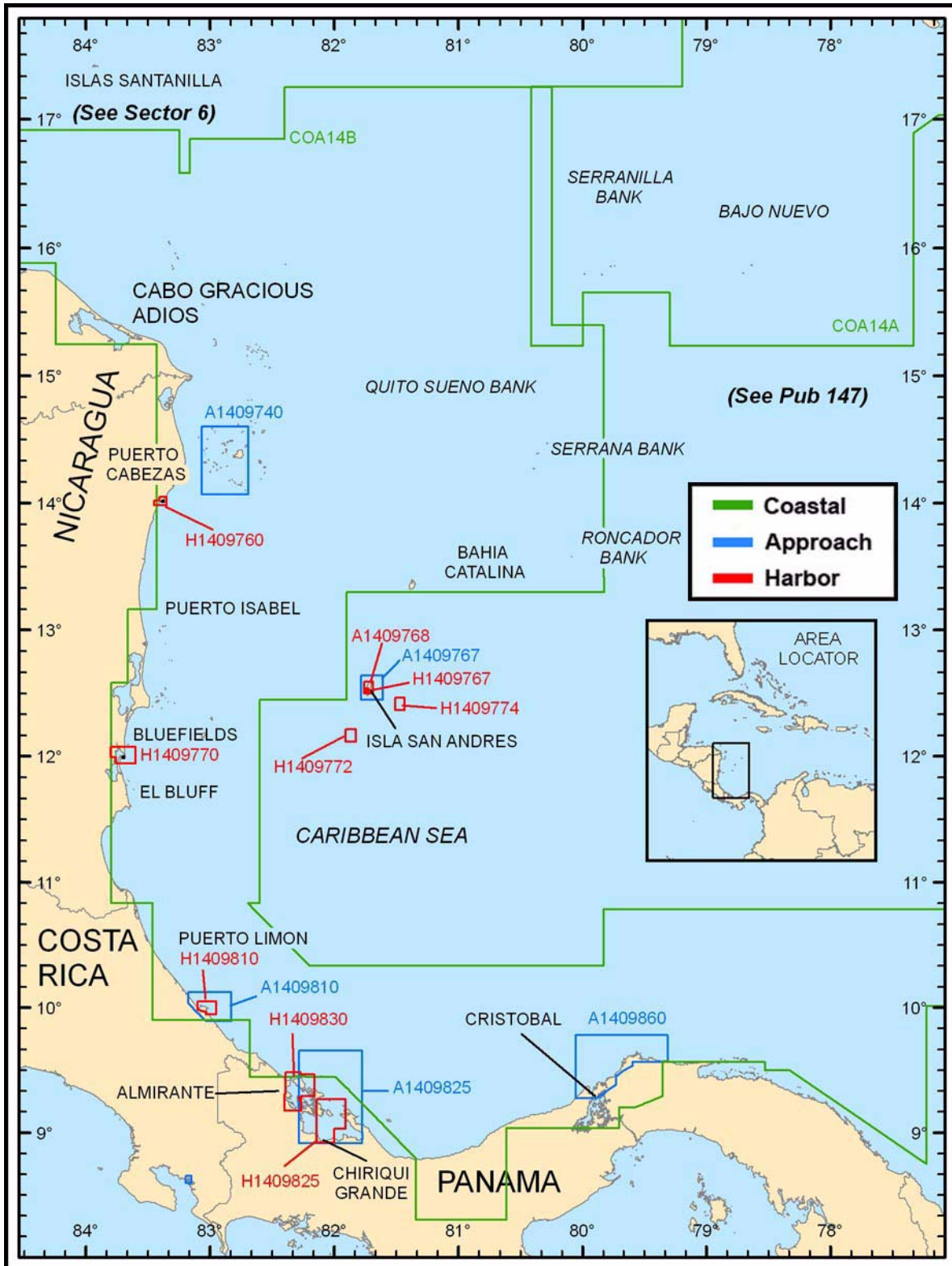

Additional DNC library coverage may be found in NGA DNC 14 (Limited Distribution) disc within the README\GRAPHICS folder.

SECTOR 5 — DNC LIBRARY INFORMATION

## SECTOR 5

### COASTS OF PANAMA, COSTA RICA, AND NICARAGUA—THE PANAMA CANAL TO CABO GRACIAS A DIOS

**Plan.**—This sector describes the N and E coasts of Central America from Brujas Point, Panama to Cabo Gracias a Dios, Honduras, including Cayos de Perlas and Cayos Misquitos. It then describes Isla de San Andres, Isla de Providencia, and other off-lying islets, banks, and dangers. The descriptive sequence is W then N.

#### General Remarks

**5.1** This sector includes that part of the Central American coast which lies between the Panama Canal and Cabo Gracias a Dios, 383 miles NNW. It includes a part of the N coast of Panama and the E coasts of Costa Rica and Nicaragua.

The coast, which is low with occasional bold promontories and bluffs, is indented by several large lagoons. Aids to navigation are sparse, but sufficient to allow for safe navigation to the important commercial ports.

Depths along the coast are ample from Brujas Point to Punta del Mona, with the 200m curve lying from 3 to 11 miles offshore, except in the vicinity of Escudo de Veraguas, where it lies 20 miles offshore. From about 30 miles S of Punta del Mona, the 200m curve extends generally NE to a position about 29 miles E of that point. From there, the 200m curve continues NE to a position about 90 miles E of Cabo Gracias a Dios. Within this curve, N of Punta del Mona, the depths are very irregular and range from 20 to 55m. There are numerous off-lying dangers, cays, and islets between Punta del Mona and up to about 65 miles N of Bluefields, where they become less frequent. The outermost of these lie about 60 miles offshore. Between Puerto Cabezas and Cabo Gracias a Dios, these dangers again become very numerous.

The western Caribbean, outside the 200m curve off Nicaragua and Honduras, is fouled and marked by scattered banks, cays, and islands. Cayos de Albuquerque, located 107 miles E of Bluefields, and Serranilla Bank, located 187 miles ENE of Cabo Gracias a Dios, are the S and E dangers of those described in this sector. Rosalind Bank and the dangers W and NW of it are described beginning in paragraph 6.4.

Many of the cays and islands are on banks that are steep-to and composed of coral. These banks should be approached with caution at all times and given a wide berth at night. The aids to navigation are few and unreliable, and the currents are fairly swift and unpredictable, especially after storms.

**Winds—Weather.**—In the area covered by this sector, the Northeast Trade Winds prevail during most of the year, although strong N winds are frequent and may reach gale force for short periods of time, especially during the winter months.

There is clear sunny weather over the whole area, except during the wet season, which prevails from May or June until November or December. This season is usually marked by frequent heavy rain squalls and thunderstorms of short duration. Sea fog seldom occurs in any part of the area.

Several hurricanes cross the Caribbean Sea during the season

from June to November, but very rarely do they travel S of 15°N. However, rough seas and heavy swells occur during the passage of a hurricane further N.

During the season of the northers, which occur from October to April, heavy rain accompanied by rough seas and swells may be experienced by vessels in exposed coastal areas. Those northers which do reach the coasts of Nicaragua, Costa Rica, and Panama are usually short-lived and seldom reach gale force.

While fogs are rare, the frequent heavy rains may reduce visibility as much as the thickest fogs. The summits of inland peaks are usually enveloped in clouds and seldom visible, except at dawn or on sudden cessations of heavy rains, when the atmosphere will almost instantly become remarkably clear.

**Tides—Currents.**—Throughout the year, the highly constant offshore Equatorial Current sets WNW at a mean rate of 0.5 to 1 knot. A few currents in the area have been observed to set at a rate of 2 knots; the maximum rate reported was between 3 and 4 knots. As the current approaches Mosquito Bank, the greater part is deflected NW at a mean rate of 1.5 knots.

The main current sets through the off-lying islands S of Serranilla Bank in directions mostly between NW and SW at a mean rate of 1 knot and a maximum rate of 2 to 3 knots. The greater part then sets N to NW around Mosquito Bank but, in the vicinity of Isla de Providencia, a part of the current is deflected SW toward San Juan del Norte, where it turns S and later rounds Golfo de Los Mosquito continuing E as a countercurrent with a mean rate of 1 knot. Over Mosquito Bank, inshore of these deflected currents, the currents are variable and to a large degree dependent on the prevailing winds. In particular, a norther may cause a current of 0.5 to 1 knot to set S close inshore along the entire bank S of Cabo Gracias a Dios to join the countercurrent in the vicinity of San Juan del Norte.

#### Brujas Point to Punta Valiente

**5.2 Brujas Point** (9°21'N., 79°59'W.) is a bold rocky wooded headland. Brujas Rock, a bush-covered rock, 11m high, stands close offshore about 0.5 mile NE of the point. It is prominent when open of the point and its sides are perpendicular.

From Brujas Point, the coast extends about 2.5 miles SSW to the entrance to the Rio Chigress. The coastline consists of rocky bluffs topped with thick vegetation. There are no conspicuous features visible from seaward.

The Rio Chigress is the outlet for the surplus waters of Gatun Lake. The flow is regulated by spillways in Gatun Dam. Three promontories stand on the N side of the river entrance. The N promontory is 37m high. The S promontory, about the same height, is marked by the ruins of a fort and a castle. Punta Arenas, on the S side of the river entrance, consists of a low,

sandy beach backed by trees. Heavy breakers extend off the beach. The town of Chigress stands on the N bank of this river.

Lajas Reef, a rocky ledge nearly awash in the fairway for the Rio Chigress, lies 0.1 mile W of the W extremity of the S promontory. Two channels lead on either side of Lajas Reef and then across a bar into the river. There was a reported (1952) least depth of 3m in the channel E of the ledge and 4.3m in the channel W of the ledge. Four beacons, with a diagonal black stripe on each, stand on the S side of the entrance. One pair of beacons, in line bearing 156°, leads through the E channel and another pair of beacons, in line bearing 130°, leads through the W channel. Another pair of beacons stand on the E bank of the river and, in line bearing 101°, lead from the intersection of the two entrance channels into the river.

Anchorage can be taken off the river, in a depth of 18m, mud, with the ruins of the fort and castle bearing 123° and Brujas Rock bearing 055°.

From Punta Arenas to Punta Boca de la Furnia, 0.8 mile WSW, the coast is low and sandy. The mouth of a small creek lies E of the point. A rock, awash, and some below-water rocks lie off the mouth of the creek.

**5.3** From Punta Boca de la Furnia to Los Morrillos, where the coast rises, a group of above-water rocks lies close off an abrupt cliff, 0.5 mile WSW of Los Morrillos. From Los Morrillos to the Rio Pina, about 2.5 miles farther SW, the coast is fronted by red clay banks. The village of Pina stands on the N side of this river.

Morro Guisao, a rocky promontory 15m high, is located 2.8 miles SW of Pina. The village of Lagarto is situated on the S side of the entrance to the Rio Lagarto, 0.8 mile farther SW.

Between the Rio Lagarto and Punta Rincon, about 43 miles SW, the coast continues low with a few occasional cliffs. A range of hills rises about midway along this stretch of coast and backs the shore for a distance of 18 miles.

From Lagarto, the coast extends WSW for about 3 miles to the Rio Salud and continues in the same direction for 8.5 miles to a ridge of low, red cliffs about 0.5 mile long, with a 108m round hill in the middle of them. The coast then extends 2.5 miles SW to the village of Donoso, on the E bank of the Rio Miguel.

The Rio Mangle, 8 miles farther SSW is marked by a low, rocky point on the E side of the entrance. Behind this point the Sierra de Miguel de La Borda rises abruptly to a height of 180m and continues to its 473m high summit 5 miles SSE of the river mouth.

Pilon de Miguel de La Borda rises to an isolated conical peak, 509m high, 15 miles SE of the entrance to the Rio Mangle.

From Punta Platanal, 3.5 miles W of the Rio Mangle, the coast extends 5 miles SW to the Rio Cocle del Norte, with the village of the same name on its E bank.

**Sierra de Cocle de Norte** (9°02'N., 80°34'W.) rises to a conical peak, 436m high, 4 miles S of the mouth of the river of the same name.

**5.4 Punta Rincon** (9°01'N., 80°41'W.), a bold, rocky, headland, rises to a height of 168m about 0.8 mile inland, and a height of 244m, 3 miles to the S.

Between Punta Rincon and Punta Icaica, 58 miles W, the

coast is indented 12 miles S by the head of the Golfo de Los Mosquitos. This entire stretch of coast is backed by a mountain range which follows the coast for almost its entire length.

From Punta Rincon, the coast gradually decreases in height and extends 19 miles SW to the Rio Concepcion, which has the town of Concepcion on its E bank. About 1.5 miles SW of the river entrance there is a conspicuous red cliff, 30m high. Punta Zapatero, a low, sandy point 1 mile W of the river, is marked by breakers which extend about 0.5 mile offshore.

The Cordillera de Veragua, a mountain range, rises abruptly to a height of 318m about 4 miles WSW of Punta Zapatero and 2 miles inland. This range attains a height of over 2,133m and traverses the Isthmus of Panama for a distance of 70 miles from E to W about 15 miles from the coast.

**5.5** Silla de Veragua, at the E extremity of the range and 20 miles SSE of Punta Rincon, rises from the Panamanian plain to a height of 1,350m. When viewed from the NW this mountain resembles a double peak or saddle. Castle Choco, a mountain rising 15 miles W of Silla de Veragua, ascends almost perpendicularly to a flat 1,933m summit which has the appearance of a huge square castle with a small tower at one angle. From the base of Castle Choco, irregular wooded hills extend NW and attain an elevation of 948m, 6 miles SSW of Punta Zapatero. The base of this range then backs the shore and extends to about 8 miles S of Punta Icaica.

From Punta Zapatero, the coast extends 3.5 miles WSW to the Rio Bejuco. The river discharges into the head of a sandy bay, about 0.8 mile wide. The W entrance point of the bay is a high, rocky bluff.

From a position 4 miles W of the Rio Bejuco, some prominent red cliffs, 30 to 61m high, extend 2.5 miles W. When the sun shines on these cliffs they glitter and sometimes resemble white sails. The E cliff has been likened to the stern of a large ship.

A high, bold, rocky headland lies 0.8 mile E of where the Rio Candelaria (8°48'N., 81°11'W.) discharges into the sea. The Rio Calovebora discharges through a wide valley 2 miles W of the Rio Candelaria. Some red cliffs, topped by trees, lie about 0.8 mile W of the river. A ridge rises gradually to a height of 797m, 5 miles SE of the river mouth.

**5.6 Punta Coaica** (8°48'N., 81°17'W.), low and sandy, is the S point of the coast on this side of the Isthmus of Panama. From this point, the coast extends W about 7 miles to a ridge of red cliffs, and then 4.5 miles farther W to a bold promontory consisting of two bold headlands close together. Punta Penasco de Guapan lies 1.5 miles farther W. All three bluffs rise steeply to rounded cones, 213 to 245m high. Pico del Rey Buppan, standing 4 miles S of Punta Penasco de Guapan, is a narrow hill, 758m high, backed by a higher mountain.

From a position 2 miles W of Punta Penasco de Guapan, a low sandy beach extends NW in a very regular sweep for a distance of 19 miles and terminates at Punta Icaica (Coco Plum Point) (9°02'N., 81°43'W.). The entrance to the Rio Cana is located 1.5 miles SE of Punta Icaica.

**Escudo De Veraguas** (9°06'N., 81°34'W.) is located with its W extremity lying 10 miles ENE of Punta Icaica. This island is low and wooded, the trees being 30 to 55m high. Reddish brown cliffs, 12 to 15m high, stand on the E side of the island.



A light is shown from this side of the island. The W and S sides of the island are low and swampy, with dark sandy beaches.

**Tides—Currents.**—During the daytime, there is usually a W current in the anchorage. There is usually a NW current between Escudo de Veraguas and the mainland.

**Anchorage.**—Vessels can anchor off the SW extremity of the island, but the holding ground is poor and may not be safe at all times.

**5.7** The coast between Punta Icaca and Punta Valiente is irregular and extends 14.5 miles NW along Peninsula Valiente. Reefs fringe Punta Icaca and Punta Vieja Isabel (Old Bess Point), 3 miles NW. The wooded coast about midway between these two points rises to a height of 142m.

Punta Gorda de Tobobo, a bold headland 152m high, stands 5 miles NW of Punta Vieja Isabel. An irregular shoal bight, with a dangerous reef extending across it, lies between these two points.

**Cayo de Platanos** (Big Plantain Cay) (9°08'N., 81°48'W.) lies near the outer edge of a rocky reef which extends 1 mile NE from Punta Gorda de Tobobo. Tobobo Bank, a detached shoal with a least depth of 12.8m and marked by heavy rollers, lies about 5.5 miles E of Cayo de Platanos.

From Punta Gorda de Tobobo, the bold high coast extends 5 miles NW to Punta Chiriqui. Several rugged islets lie close off this latter point. From Punta Chiriqui, the coast extends 2.3 miles W to Punta Valiente.

## Punta Valiente to Punta Terraba

**5.8** Between Punta Valiente and Punta Terraba, the current sets SE at a velocity of about 2 knots. Currents setting E at velocities of 1 to 2 knots will be encountered in the approaches to Canal del Tigre and Boca del Toro.

**Punta Valiente** (9°11'N., 81°55'W.), a bold, densely wooded point, rises to an elevation of 152 to 183m on the E side of the E entrance to Laguna de Chiriqui. Foul ground extends 1.3 miles W from the point and continues S about 1.8 miles to the entrance to Bluefield Creek. Cayos Valiente, a group of islets extending about 0.3 mile in an E-W direction, lie on the N part of this reef. Virginia Rocks lie on the W edge of the reef 1.3 miles WSW of Punta Valiente, and Bluefield Rock, a small black rock 9.8m high, stands on the S edge about 1.5 miles S of the point.

**Pico Valiente** (9°10'N., 81°55'W.), a conspicuous 213m high hill, stands 1 mile S of Punta Valiente.

**Cayos Tigre** (Tiger Cays) (9°13'N., 81°55'W.), consisting of several red clay islets about 1 mile long in a E-W direction, lie 1.8 miles N of Punta Valiente. Roca Tigre, a detached small rock, marked by a beacon, equipped with a racon, lies 2.5 miles NNW of Punta Valiente. Reventazones Tigre, a small rock awash, over which the sea usually breaks, together with several shoal patches, lies on a bank within 0.8 mile NW of Roca Tigre. During calm weather, Reventazones Tigre cannot always be seen.

A 7m coral patch lies 0.3 mile WNW of Reventazones Tigre.

**5.9 Laguna de Chiriqui** (8°56'N., 82°07'W.) (World Port Index No. 9825), a deep bay, is 30 miles long, lies in an E-W direction, and is 10 miles wide. It is bound on the E side by

Peninsula Valiente, on the S and W sides by the mainland, and on the N side by Isla Popa, Isla Cayo de Agua, and the adjacent islands and reefs. Canal del Tigre, which lies between Peninsula Valiente and Cayo de Agua, is the main approach channel.

The N side of the lagoon, including the entrance, is fringed by detached shoals. These lie up to about 5 miles S of the entrance and along the E shore of the lagoon. The W end of the lagoon, S of the fringing reefs, is almost entirely clear of dangers. A pier extends 320m ESE from a small village close S of Cemetery Cay from the W end of the lagoon.

The low shores of the lagoon are indented by numerous small bays and rivers and are marked by several villages.

**Canal Valiente** (9°12'N., 81°55'W.), the NE approach channel leading into Canal del Tigre, lies between Cayos Tigre and the W end of Cayos Valiente, and has depths of 12.8 to 18.3m in the fairway on either side of Reventazones Valiente, a 5.5m shoal area about 0.8 mile NW of Virginia Rocks. There is usually a very heavy swell in the channel.

The flood current in Canal Valiente sets SW at a velocity of 0.5 to 1 knot; the ebb sets in the opposite direction at a velocity of 1 to 2 knots.

**5.10 Canal del Tigre** (Tiger Channel) (9°11'N., 81°59'W.), the N approach to Laguna de Chiriqui, lies between Roca Tigre and the SE side of Cayos Zapatilla to the W. This channel lies between two 40m curves which converge from E and W and extends S between Reventazones Tigre, awash, about 0.5 mile WNW of Roca Tigre, and Cayos Zapatilla. It enters the lagoon between Punta Bluefield to the E and Punta Piedra Roja (9°09'N., 82°00'W.) to the W.

Channel depths range from 36 to 72m, but some lesser depths may be encountered. The channel fairway has been dredged to an effective depth of 18.3m. Inside the lagoon and on the W side of the channel an extensive shoal lies between 2.5 miles S and 5 miles SW of Punta Piedra Roja. On the E side of the channel, there are two detached shoals, with depths of 5.5m and less, which lie 2.5 and 4 miles S of the same point.

Another channel leads into the lagoon between the W side of Cayo de Agua and Isla Popa (9°10'N., 82°08'W.) to the W, but is not recommended without local knowledge.

Bluefield Creek, entered 1.5 miles N of Punta Bluefield, extends 2 miles E to its head and is considerably narrowed by fringing reefs. Cayos del Toro, a small group of islets, lies on the S side of the approach to this creek on the outer edge of an area of foul ground which extends 1 mile NNW and N from Punta Bluefield. Densely-wooded hills rise on the N side of the creek. The head of the creek is swampy and fringed with mangroves.

Sheltered anchorage can be taken, in a depth of 20m, mud, with Bluefield Rock bearing 292°, distant 0.7 mile.

**Caution.**—When entering the creek, vessels should avoid the 5.5 m shoal depth lying about 1.3 miles W of Bluefield Rock. Areas of uncharted shoals lie SW of Isla Agua and Peninsula Valiente as seen on the chart.

**5.11** The **Rio Cricamale** (8°59'N., 81°55'W.) has its mouth lying close W of Cricamale, a village which stands on a salient point backed by trees up to 37m high. A low mangrove-covered cay located W of this point divides the river mouth into two channels. The Rio Biarra enters the lagoon close W of a

defined point lying 5 miles WSW of the Rio Cricamale.

The S side of the lagoon extends irregularly W from the Rio Cricamale for 20 miles to Punta Muerto (9°00'N., 82°15'W.). The principal settlement of Chiriqui Grande is situated midway along this stretch of coast and is reported to be radar prominent.

**Tides—Currents.**—Tidal currents are seldom experienced within Laguna de Chiriqui, but a N set may be caused by the rivers. In the dry season, from March to June, off the mouth of the Rio Cricamale and as far as the entrance to Canal del Tigre, the ebb current attains velocities of 0.5 to 1 knot; there is a weak flood current on the rising tide.

**Depths—Limitations.**—Two SPM offshore oil facilities are situated just offshore, NNE and NE of Chiriqui Grande village. Submerged pipelines extend from the shoreside facility, close N of Chiriqui Grande, to these terminals. The facility can accept vessels of 30,000 dwt at the pier and 120,000 dwt at the SPM. The depth in the approach channel is 36.6m. The controlling depths at the SPMs is 20m.

A general cargo terminal has been constructed at Chiriqui Grande.

**Pilotage.**—Pilotage is compulsory. Pilots board in Canal del Tigre, 2.8 miles WSW of Roca Tigre. Pilots should be requested at least 72 hours in advance. If the ETA changes by more than 4 hours, a new ETA should be sent.

Vessels may proceed directly through the buoyed channel to the anchorages in the lagoon. Outbound vessels have priority in the channel. A berthing master is mandatory when securing to the SPMs. The pilot remains on board during loading operations. Vessels anchored within the lagoon should minimize the use of VHF channel 13.

**Contact Information.**—When inside 50 miles of the terminal, a vessel should contact the oil terminal (call sign: Rambala Control) on VHF channel 16.

Pilots can be contacted (call sign: Chiriqui Grande Pilots) on VHF channels 11, 12, 13, 14, and 16.

**Anchorage.**—Secure anchorage can be taken in most parts of Laguna de Chiriqui. Vessels can anchor, in depths of 12.8 to 18m, mud, SE of the pier at Eureka (8°57'N., 82°07'W.).

There are also three anchorage berths available for vessels awaiting their turn at the SBMs.

The E berth (8°59'18"N., 81°59'30"W.) has a depth of 27m, the middle berth (8°59'48"N., 82°01'30"W.) has a depth of 35m, and the W berth (9°00'18"N., 82°03'30"W.) has a depth of 40m.

**Caution.**—Focused attention is required in entering the lagoon because the water in the entrance is not very clear and shoals may not be seen. Since the shoals are steep-to, soundings are of little help. The water lying S of the entrance is reported to be clear and shoals may be seen.

**5.12** From Punta Muerto, the W side of the lagoon extends about 10 miles N to Monkey Cay (9°10'N., 82°15'W.) near the head of Ensenada Uyama. Several villages which serve the plantations inland stand along this stretch of coast. The greater part of the S and W sides of the lagoon are low and swampy, but toward the W part of the S shore the land rises to several high peaks 3 miles inland. Along the W shore, the land rises to a height of 457m, 4 miles inland.

The N coast of the lagoon between Monkey Cay and Punta

Piedra Roja, 15 miles E, passes along the S coasts of Isla Split Hill (9°09'N., 82°10'W.), Isla Popa, and Isla Cayo Agua.

The S part of Isla Popa rises to a height of 115m; Cerro Popa is a prominent 109m high peak in the NE part of the island. Isla Split Hill, 1.3 miles long, lies between the SW end of Isla Popa and the mainland to the W. Two narrow channels lead on either side of this island into the Bahia de Almirante, but both require local knowledge.

**5.13 Isla Bastimentos** (9°18'N., 82°08'W.), from its E extremity of Punta Patino, extends 8 miles NW to Cabo Toro, the E entrance point of Boca del Toro.

**Cabo Toro** (Punta Toro) (9°22'N., 82°12'W.), a bold headland, terminates to the N in a conspicuous, 35m high rock. A steep-to, breaking reef fringes the point and extends 1.5 miles SW around Punta Bastimentos, which is low and sandy, and the W end of Isla Bastimentos. Roca Toro lies, awash, close NE of Cabo Toro; several rocks lie up to about 1 mile ESE and SE of the point. A shoal depth of 6.6m lies 1 mile ENE of the point.

A ridge of irregular hills standing on the N side of Isla Bastimentos attains an elevation of 122m, but the S side of the island is low.

**Crawl Cay Channel** (9°14'N., 82°08'W.), fouled by several cays and shoal depths, lies between the S end of Isla Bastimentos and the N end of Isla Popa, and extends W into the E part of Bahia de Amirante. Local knowledge is necessary to enter this channel.

**Cayo Nancy** (9°19'N., 82°11'W.) lies with Hospital Point, its NW extremity, located 0.8 mile SSW of Punta Bastimentos. The densely-wooded island extends 3.5 miles SE and is nearly joined to a W projection of Isla Bastimentos. Hospital Bight, an encumbered inlet, lies between Cayo Nancy and Isla Bastimentos. The bight should not be entered without local knowledge.

**5.14 Isla Colon** (9°25'N., 82°17'W.), densely-wooded, about 6.5 miles long, and from 3 to 4 miles wide, rises to heights of 61 to 122m. From Long Bay Point, a 16m high rocky bluff, located 2.8 miles NW of Cabo Toro, the N coast of the island, extends 4.2 miles NW to Punta Norte, low and rocky, and then 2.3 miles WSW to Punta Cauro (9°26'N., 82°19'W.). The SE part of the island is a low peninsula.

**Cayo Carenero** (9°21'N., 82°14'W.), a low, narrow island fringed by foul ground up to about 0.3 mile E, lies close off the E side of Bocas del Toro. Roca Norte, 6.4m high and conspicuous, stands close N of Cayo Carenero.

Bahia de Almirante, 15 miles long and 10 miles wide, is bound by Isla Popa, Isla Bastimentos, and the adjacent islands and dangers to the E; Isla Colon to the N; and the mainland to the S and W. The commercial port of Almirante and the town of Bocas del Toro are the only two towns of any size within the bay. Several small towns and villages are found along the shores of the bay, but they have little or no commercial importance.

Isla San Cristobal, the largest of several islands found within the bay, lies almost in the middle and divides it into three large bights. The E end of the bay is fringed by numerous cays and reefs, whereas the central and SW parts are comparatively free of dangers. General depths within the bay are 12.8 to 27.4m,

but less water is encountered in the NW and SE bights.

The irregular coast forms numerous bights and lagoons, into which several rivers discharge. The S side of the bay is backed 2 miles inland by a table ridge, which ranges in height from 533 to 614m and which extends 15 miles from the SE to the NW. The mainland SE and the islands to the E and N rise to heights of about 150m, but the mainland coast at the NW end of the bay is low.

**5.15 Canal de Bocas del Toro** (9°20'N., 82°15'W.), the principal entrance channel, lies between Cabo Toro and Long Bay Point and is about 0.8 mile wide between Isla Bastimentos and Cayo Carenero. However, both sides are fringed by coral reefs and detached shoals which narrow the navigable width of the channel.

The buoyed channel between Lighted Buoy No. 1 and Lighted Buoy No. 2, as far S as Lighted Buoy No. 5 and Lighted Buoy No. 6, has a depth of 9.1m. From there, it has depths in excess of 12.2m, except for the 9.7m patch which extends 90m S of Lighted Buoy No. 7, a 7.5m patch lying close E of Lighted Beacon No. 8, and the W edge of Dry Reef, which extends, with a depth of 8.4m, close SW of Lighted Beacon No. 9. This latter beacon was reported (1995) to be missing.

**Nancy Shoal** (Bajo Solarte) (9°20'N., 82°13'W.), with a least depth of 2.5m, lies about midway between Punta Bastimentos and Hospital Point and extends about 0.5 mile NNW. Nancy Rock (Roca Solarte), a reef with a depth of less than 1.8m and on which the sea generally breaks, lies on the S end of this shoal.

Shepherd Bank (Bajo Garcia) fronts the S end of Bocas del Toro, about 0.8 mile SW of Hospital Point, and has a least depth of 5m. Clear channels pass SE and NW of this bank. Pallas Shoal, a detached shoal with a least depth of 5m, lies about 0.5 mile SSW of the S extremity of Cayo Carenero.

A current, which enters Bahia de Almirante through Boca del Drago and emerges through Bocas del Toro, sets SE along the S side of Isla Colon. As a result, the ebb is increased and the flood is decreased in Canal de Bocas del Toro. A velocity of 1 knot is sometimes encountered. In the approach to Canal de Bocas del Toro, a SE setting current with a velocity of 1 to 2 knots will be encountered.

**5.16 Boca del Drago** (9°25'N., 82°20'W.), the W entrance leading into Bahia de Almirante, lies between the W end of Isla Colon and the mainland to the W. This passage is 0.8 to 1.3 miles wide, but the channel is only about 0.3 mile wide between the 10m curves in the entrance and about 340m wide at its narrowest part. Because of the sharp turns and lack of navigational aids, it is not advisable for a vessel other than one of shallow draft to attempt to enter without a pilot.

Sail Rock, Wreck Rock, and Swan Cay, all above-water dangers, lie between 2 miles and 2.3 miles NE of Punta Cauro, on the E side of the approach, and have been reported to be radar prominent. These features could be as much as 100m out of position to the SW and should be given a wide berth.

The E side of the channel between Punta Cauro and Lime Point, a low and sandy point about 1 mile SSW, is fringed by shoal ground and detached shoals which extend up to 1 mile offshore.

**5.17 Punta Sarabeta** (9°26'N., 82°20'W.), the W entrance point of Boca del Drago, lies 1 mile W of Punta Cauro and is fringed by foul ground extending about 0.8 mile E into the channel. Five Fathom Bank, small in extent, with a least depth of 9.1m, lies on the W side of the approach 1 mile NE of Punta Sarabeta. Mandeville Rock, a dangerous pinnacle with a least depth of 2.4m, lies 0.5 mile ENE of the same point. The sea occasionally breaks over this danger.

The currents in Boca del Drago are irregular in set and velocity. When a strong current sets E outside the passage it is deflected into the passage where it attains a velocity of 1 knot on the flood, but is inappreciable during the ebb.

The W part of Bahia de Almirante extends 14 miles S from Punta Anton on the W side of Boca del Drago. Punta Pondsock, the E extremity of a peninsula, is located about midway along the W side of the bay and 3 miles W of Punta Juan. An inner bay, which is entered between Punta Pondsock and Juan Point (Punta Juan), extends 6.3 miles S from a line joining those points to the head of Logan Bight, and about the same distance WNW from the middle of the W side of Isla Cristobal to the head of Ensenada Ambrusio, a bight with the port of Almirante at its head.

**Laguna Porras** and **Laguna Palos** (9°14'N., 82°15'W.), two almost landlocked bodies of water at the S end of Isla Cristobal, are available only to small craft with local knowledge.

Ensenada Shepherd lies in the SW side of Bahia de Almirante between Punta de Pargo (9°12'N., 82°19'W.) and Punta de Gallinazo, 3.8 miles NW. Isla Pastores, together with several small cays, lies across the entrance to this bay on a line joining the two above points. Two channels lead into the bay. The NW channel lying between Isla Pastores and Punta de Gallinazo is fouled by an extending shoal, whereas the SE channel lying between Cayo Roldan and Punta de Pargo is deep and clear, except for a detached 14.6m depth which is located near mid-channel.

Anchorage can be taken, in a depth of 22m, mud, about 0.5 mile S of the middle part of Isla Pastores.

**5.18 Split Hill**, 336m high, stands 2.1 miles SE of Punta de Pargo. Middle Channel Hill, 106m high, stands on the E part of Isla Pastores. Both of these peaks are prominent.

**Sister Cays** (9°16'N., 82°21'W.), two reef-fringed islets, stand near the outer end of an area of foul ground extending 1 mile SE from the coast, about midway between Punta de Gallinazo and Punta Pondsock, 3.2 miles NNE.

**Ensenada Ambrosio** (Ambrosio Bight) (9°16'N., 82°22'W.), entered between Punta Gallinazo and Sister Cays, extends 3 miles NW to the port of Almirante at its head. Depths within the bay range from 27m in the entrance to a depth of 10m at its head. There are several cays located close along its shores and a 9.2m shoal lies at the mouth of Ensenada Ambrosio, 1 mile SSE of Gerechow Cay.

**Pondsock Reef** (9°17'N., 82°20'W.) lies on an area of foul ground extending about 1.5 miles ESE from Punta Pondsock. Two above-water wrecks lie near the SE end of the reef. A lighted beacon marks the SE end of the reef.

The W shore of Bahia de Almirante between Punta Pondsock and Punta Donato, 5.3 miles N, recedes 2.5 miles W in its middle part. All of the dangers between the two points are contained within the 10m curve, which lies between 0.5 and 1.3

miles offshore.

The N side of the W part of Bahía de Almirante is bordered by the SW coast of Isla de Colon, which extends 6.5 miles SE between Punta Rancho and Mangrove Point, the SE extremity of the island. The 10m curve lies about 0.1 mile offshore between these two points and contains most of the dangers. An 18.3m shoal patch lies 0.8 mile offshore, about 3 miles NW of Mangrove Point; NW of this patch, about 0.5 mile offshore, there are several detached reefs with depths of less than 1.8m.

**Anchorage.**—Vessels can anchor practically anywhere in Bahía de Almirante and in many places can lie safely close offshore. Inside Boca del Drago, good anchorage can be taken S and W of Lime Point, in depths of 9 to 13m, mud.

**5.19 Bocas del Toro** (9°21'N., 82°14'W.) (World Port Index No. 9840) lies at the inner end of Canal de Bocas del Toro, on the E extremity of the low peninsula at the SW end of Isla de Colon. It consists of an inner anchorage and an outer anchorage lying SE of the town. There are no alongside berthing facilities for vessels and cargo must be worked into barges. The town has one pier, 53m long, with a depth of 6.4m alongside; it is used by barges and small coastal vessels.

**Pilotage.**—Pilotage is compulsory for Canal de Bocas del Toro and advisable for Boca del Drago. Pilots are stationed at Bocas del Toro and board about 1.3 miles NNW of Cabo Toro. The pilot should be requested on VHF channel 16 when about 30 miles off. The pilot boat can be contacted on VHF channel 12.

**Anchorage.**—Vessels can anchor as convenient in the outer anchorage, in depths of 22 to 24m, mud, about 0.5 mile from Pallas Shoal and 0.8 mile S of Cayo Carenero. Good inner anchorage can be found, in depths of 13 to 18m, about 0.2 mile SSW of Cayo Carenero, but vessels approaching this anchorage must avoid Pallas Shoal and the patches within it. Small vessels can anchor off the town.

**Caution.**—Muddy water in the approaches to Canal de Bocas del Toro may obscure the shoals. The sea never breaks across the entrance. Allowance should be made for the E current at the entrance. A 0.9m shoal lies at the extremity of a spit extending about 1 mile NW from Punta Coco (9°18'N., 82°16'W.), the NE extremity of Isla San Cristobal.

**5.20 Almirante** (9°18'N., 82°24'W.) (World Port Index No. 9830), a banana-loading port, stands at the head of Ensenada Ambrosio in the SW corner of Bahía de Almirante. The banana berth is 199m long and has a maximum depth alongside of 9.1m. The general cargo quay is 107m long and has alongside depths of 9.7 to 10.3m. Vessels are advised to moor starboard side-to.

The morning has been reported to be the best time to berth as high winds usually prevail the rest of the day.

**Pilotage.**—For pilotage information, see Bocas del Toro in paragraph 5.19.

**Anchorage.**—Good anchorage can be taken, in depths up to 27m, within the bay. Anchorage can also be taken close off the pier, in depths of 15 to 18m.

**Caution.**—A shoal depth of 7.8m lies close S of the E end of the quay.

## Punta Terraba to Punta Mono

**5.21 Punta Terraba** (9°26'N., 82°21'W.) is the NW extremity of a small, wooded peninsula forming the W side of the entrance to Boca del Drago. The N side of the point is reef-fringed and usually marked by heavy breakers. Foul ground extends about 0.5 mile from the W side of the point and up to 1 mile S from it.

Between Punta Terraba and Punta Mona (9°38'N., 82°37'W.), a conspicuous broad headland of white cliffs 20 miles NW, the coast is low, regular, and broken by several rivers. Isla Mona, a 27m high rock, lies close SE of the point and may be identified by the hole worn through it by sea action. Immediately behind the point, Monkey Hills rise to a height of 155m and 11 miles SW of it stands a 948m high peak.

Between Punta Mona and Punta Cahuita, a low rocky point located 13 miles NW, the coast extends irregularly and recedes in its middle part to form an embankment. An isolated hill rises steeply from the sea to a height of 218m, about one quarter of the distance along this section of coast. Punta Uva, low and rocky, lies 4 miles W of Punta Mona. Several shoals, with depths of 10 to 14.6m, lie between 2 miles and 4 miles SE of Punta Cahuita. This point is bordered by a breaking reef. Pico Vargas, 347m high, stands 5 miles SW of Punta Cahuita.

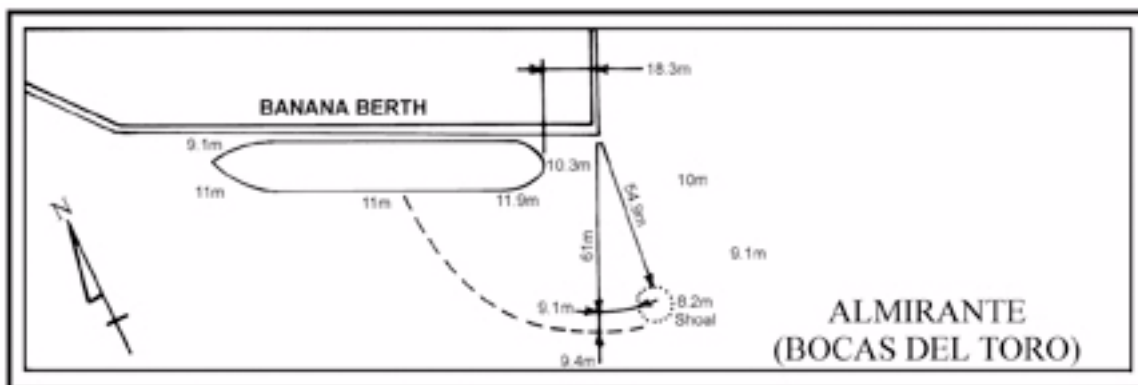

Almirante (Bocas del Toro)

**Punta Blanca** (10°00'N., 83°02'W.), 20 miles NW of Punta Cahuita, is a bold white, cliffy point 122m high; it is the NE extremity of a promontory extending 0.5 mile E from the general line of the coast. A prominent 1,375m high peak of the Matama range rises 15 miles SSW of Punta Blanca. Isla Uvita, small in extent, lies on a coral reef lying 0.8 mile E of Punta Limon. A dangerous wreck lies 0.3 mile E of Punta Blanca.

**5.22 Puerto Limon** (10°00'N., 83°01'W.) (World Port Index No. 9810), an open coastal harbor, is the principal Costa Rican port on the Caribbean coast. Bananas and cocoa are the principal exports, but a considerable amount of general cargo is also handled. It is an increasingly popular port for cruise ships. It has been reported (2007) that the old banana berth is no longer used and all banana loading takes place at Puerto Moin.



**Puerto Limon (inner E side-Aleman Pier/Quay)**

**Winds—Weather.**—A typical Central American climate prevails in the Puerto Limon area. The annual mean daily temperature is 31°C. The annual mean relative humidity is 85 per cent. The rainfall is heavy, frequently torrential, and varying from 2,600 to 4,800mm per year. Fog occurs only in the early mornings and is generally very light.

**Tides—Currents.**—A S setting current is generally experienced between Isla Uvita and Puerto Limon. During the dry season, it attains a velocity of less than 1 knot, and 0.7 to 1.2 knots in the rainy season. During the rainy season, there is a strong discharge from the mouth of the rivers in the NW part of the bay.

Between Punta Terraba and Puerto Limon, the current sets SE. A 2 knot current setting ESE was experienced by a vessel approaching Puerto Limon from the E.

**Depths—Limitations.**—Vessels with drafts up to 10.m and lengths up to 300m can be accommodated in Puerto Limon. At some berths, vessels are held off by hauling off buoys because of the scend. An offshore anchor is also used when the scend is heavy.

The upper T-head portion of the Metallic Pier, previously charted as Railroad Wharf and sometimes referred to as the Cruise Ship Pier, has been destroyed by hurricane activity; Berth No. 1, Berth No. 2 and Berth No. 3 no longer exist. A



**Puerto Limon**

dolphin is positioned about 40m off the SE tip of the remaining pier.

Caution is necessary as it has been reported (2009) that the alongside depths of Seventy Pier are now 7.3m on its E side and 4.3m on its W side; the pier is not a recommended berth for large ships. There is a partially-submerged wreck close W of Seventy Pier.

Old Berth No. 10 and Old Berth No. 11 are located at the Alamen Pier Terminal. Old Berth No. 10 has a depth of 10m alongside; Old Berth No. 11 has a depth of 11m alongside.

Berth	Length	Draft	Use
2-1	180m	8.0m	Bulk and general cargo
3-1	217m	10.0m	Cruise vessels
3-2	217m	10.0m	Cruise vessels
3-3	—	10.0-11.0m	
4-1	210m	9.0-10.0m	Ro-ro pier, with a ramp width of 21.0m
4-2	210m	9.0-10.0m	Containers and bulk cargo
4-3	210m	10.0m	Containers

A shoal, with a depth of 3.3m, lies close off the seaward end of Berth No. 11

**Aspect.**—In approaching the port, the sugarloaf peak at the E end of Matama range is prominent, although the coast has been reported to be a poor radar target. At night, the loom of the bright lights on the piers can be seen well out to sea, beyond the range of any of the aids to navigation. The piers are reported to be easily identifiable by day at a distance of 8 miles.

**Pilotage.**—Pilotage is compulsory for merchant vessels going alongside the wharves. Pilots may be ordered by radio



### Puerto Moin

prior to arrival or summoned by sounding four blasts on the whistle or siren. The pilot boards 1 mile off the harbor. Pilots can be contacted on VHF channels 14 and 16. An ETA should be sent 24 hours in advance.

**Anchorage.**—There is anchorage, clear of the dangerous wrecks, 1.5 mile SE of Puerto Limon. This anchorage has good holding ground and receives partial shelter from Isla Uvita. A good berth is reported to be 1 mile S of the S extremity of Isla Uvita. Anchorage can also be taken, in depths of 12 to 16.5m, about 0.4 mile WNW of the S extremity of Isla Uvita. A vessel that anchored about 1 mile S of Isla Uvita experienced dragging in E and NE winds, but found good holding ground farther E, about 1.4 miles SSE of Isla Uvita.

**Caution.**—The anchorage and piers are exposed to swell and surging may be encountered pierside. Lesser depths than charted may be encountered due to earthquake activity.

**5.23** The coast between Punta Blanca and Punta Castilla, 58 miles NW, is low, bordered by a dark sandy beach, and backed by numerous lagoons which parallel almost the entire coast 1 mile inland. There is no protection from the Northeast Trade Winds and a continuous heavy surf breaks on the shore. Depths of 5.5m are found 0.5 mile offshore, but the depths increase gradually to the 200m curve which follows the coastal trend 6 to 7 miles offshore. Excellent holding ground, over a

bottom of dark green mud, can be found 3 to 4 miles offshore, in a depth of about 36m.

**Bahia de Moin** (10°00'N., 83°05'W.) lies 3 miles W of Punta Blanca and indents the coast 1 mile. Isla Pajaros, heavily wooded and 30m high, lies off the E entrance point and the Rio Moin discharges into the SE part of the bay. A bare rock is located close off the NW side of Isla Pajaros. A light is also shown from this same side of the islet. Depths range from 18.3m at the entrance to 5.5m about 0.2 mile NW of the river mouth. A 9.1m shoal lies 0.8 mile WSW of Isla Pajaros.

**5.24 Puerto Moin** (10°00'N., 83°05'W.) (World Port Index No. 9805) lies on the E side of Bahia de Moin, N of the entrance to the lagoon.

**Depths—Limitations.**—A channel, 200m wide, with a dredged depth of 15m, leads to the berths. The port is designed for banana exportation and the importation of crude oil.

There is no turning basin and vessels must be towed in or out. It was reported (2001) that a Navy frigate-size vessel was able to back out of the port having moored port side-to at the tanker pier. There is a continual alongside surge, but it is reported to be not as strong as in Puerto Limon. The swell is most pronounced during N winds in December and January, which can cause vessels to surge alongside the berths. For berthing information refer to the **Puerto Moin—Berth Information** ta-

ble.

Puerto Moin—Berth Information			
Berth	Length	Draft	Remarks
No. 5-1	109m	13.0m	Bulk cargo, petroleum products, and asphalt. Dolphins extend berth length to 233m.
No. 5-2	200m	13.0m	Ro-ro pier, with a ramp width of 30m.
No. 5-3	150m	10.5m	Bananas and refrigerated cargo.
No. 5-4	150m	10.5m	Bananas and refrigerated cargo.
No. 5-5	150m	13.0m	Containers.

**Aspect.**—Range lights are shown from short towers marked with black and white horizontal stripes. The front marker is seen from seaward between the rooftops of two buildings at the pier. The rear marker stands on a small hill and may be partially obscured by brush. It has been reported (2001) that the range is useless, with the rear mark totally obscured by brush, and the front mark not visible if any vessel is already using the piers.

**Pilotage.**—Puerto Moin Pilots can be contacted (call sign: Moin Pilot) on VHF channels channels 10 and 16, and board about 1 mile NNE of the channel entrance buoys. Berthing is restricted to daylight hours only. Vessels should arrive before 1500; pilots will not board before 0600.

**Anchorage.**—Anchorage is located in the charted area N of the port. The holding ground of packed sand was reported excellent (2001).

**Caution.**—Depths have been reported (1993) to be as much as 1.5m less than charted due to earthquake activity.

**5.25** From Bahia de Moin, the coast extends 25 miles NW to the outlet of the Rio Parismina (10°19'N., 83°21'W.). Two other rivers, the Rio Matina and the Rio Pacuare, lie along this stretch of coast. This portion of coastline should be navigated with caution. A heavy swell always rolls in from the NE and breaks heavily on the beach.

**Volcan Turrialba** (10°01'N., 83°45'W.), a 3,460m high inactive volcano, stands 30 miles WSW of the mouth of the Rio Parismina. When seen from the E, the peak and crater appear clearly defined, with the hollow of the crater being on the N side. The volcano is generally hidden by clouds.

Monte Irazu, 3,627m high, stands close S of the above peak. On a clear day, these conspicuous peaks can be seen for a considerable distance.

From the Rio Parasmina, the low coast extends 31 miles NNW to the mouth of the Rio Colorado (10°46'N., 83°35'W.). This shallow river leads inland to the Rio San Juan and then to Lago de Nicaragua. The mud carried out by this river discolors the sea for some distance. A prominent two story red-roofed building stands in the village of Barra del Colorado, on the S bank near the mouth of the Rio Colorado.

Cerro de Las Lomas, a prominent ridge of hills, 354m high, rises 10 miles N of the Rio Parismina and 4 miles inland. This

ridge of hills is usually covered by mist rising from the marshes around them. An easily-identified conical hill, 213m high, stands between them and the shore.

**Cerro Tortuguero** (10°35'N., 83°30'W.), a small isolated hill, 137m high, stands on the coast 18 miles NNW of the Rio Parismina. This hill is a useful mark. When seen from the NE, it appears wedge-shaped, with the higher end to the E. From the E and SE, it appears as a rounded lump as broad as it is high, rising almost perpendicularly on its S side, but sloping gradually N and terminating in one or two hillocks.

The current along the coast between Bahia de Moin and Punta Castillo sets SE and increases from 1 knot to as much as 3 knots as it approaches the bay.

**5.26 Punta Castillo** (10°56'N., 83°40'W.), a low point marked by breakers located 10 miles NNW of the Rio Colorado, has the entrance to San Juan del Norte lying 2.8 miles W of it. Morris Shoal, 4 miles long and 1 mile wide, lies 10 miles E of this point and has depths of 18.3 to 22m, over soft mud.

**San Juan del Norte** (10°56'N., 83°42'W.) is located W of Punta Castillo. This place is notable as the proposed Atlantic terminus of the Nicaraguan ship canal. The harbor of San Juan del Norte has been closed to shipping because of silting and is now available only to small craft. The village and the abandoned equipment are now obscured by trees.

The best anchorage off San Juan del Norte, in depths of 18 to 20m, mud and sand, lies about 3.5 miles NW of Punta Castillo.

## Punta Mono to Bluefields

**5.27 Punta Mono** (11°36'N., 83°40'W.) is the S extremity of a bold, rocky peninsula which extends 1.5 miles SE and is 2 miles wide. Red Hill, 30m high and red in color, stands in the middle of the promontory 1 mile NNE of Punta Mono. Red cliffs extend 1 mile NW from Black Bluff, on the NE end of the promontory. Shoal water and several cays lie within 1 mile of Punta Mono.

**Isla del Pajaro Bobo** (11°30'N., 83°43'W.), a 47m high islet, is wooded and lies 5.8 miles SW of Punta Mono and 3 miles offshore. When seen from the E it appears as a small green conical hill, but from the S it appears wedge-shaped, with the higher end to the W.

**Tides—Currents.**—Between Punta Mono and Punta Gorda, the currents on the edge of the 200m curve are affected by the Equatorial Current, and generally from the vicinity of Isla de Providencia, part of the current recurves to the SW, while the main flow continues NW across Miskito Bank. Subsequently, the currents along the coast are variable and subject to great and sudden change, being influenced to a large extent by the wind; however, they tend to run S at a velocity varying from 0.5 to 3 knots. This S set has at times reversed its direction for several days before resuming its normal flow.

The current is stronger in the vicinity of Punta Mono, where it sometimes sets E, then between Cayos de Perlas and Puerto Cabezas. Between Puerto Cabezas and Punta Gorda, the current is variable, but tends to set N; however, it too may be completely reserved by a norther. A countercurrent setting S may be experienced close inshore.

**Aspect.**—The unusually low aspect of the coast is broken by a few bluffs and low hills. Several lagoons and numerous riv-

ers indent the shore and there is an occasional village.

**Caution.**—Numerous dangerous reefs and cays lie off this coast.

**5.28** From **Black Bluff** (11°37'N., 83°39'W.), on the NE extremity of a promontory, the low swampy coast extends 10 miles N to a ridge of low red cliffs which terminate 1 mile farther N at Green Point. A small ridge of low red cliffs lies about 1 mile S of Green Point. The coast continues 12 miles N from Green Point to El Bluff, on the E side of the main entrance to Laguna de Bluefields. A shallow S entrance lies about 4 miles N of Green Point and leads into the lagoon, from which Isla La Venada extends 8 miles to the N entrance. The sea usually breaks heavily on the bar at the S entrance.

Silk Grass Cay, wooded and 18m high at its SW end, lies about 1 mile SSE of Black Bluff.

**French Cay** (11°44'N., 83°37'W.), a small, wooded islet with a flat summit, 27m high, lies 7.5 miles NNE of Black Bluff on the N part of a narrow reef, 1.3 miles long.

Sister Cays, consisting of three small islets, lies 8.5 miles N of Black Bluff.

Breaking reefs lie 3 miles SE and 2.5 miles E of Green Point.

Cayo de la Paloma, reef-fringed and 33m high, with a saddle-shaped summit, lies 1.5 miles ENE of Green Point and is the largest cay in this vicinity. White Rock, 15m high and prominent, is located 0.5 mile NNW of Cayo de la Paloma. Trees cover this rock.

Guano Cay, composed of red cliffs on its sides, lies 7 miles S of El Bluff. Two breaking reefs lie 2 miles and 4.3 miles N of this cay.

**Caution.**—There are many reefs and dangers, the positions of which can best be seen on the chart, in the vicinity of the above cays.

**5.29 El Bluff** (12°00'N., 83°41'W.), a bold promontory, 43m high and wooded, stands on the E side of the entrance to Laguna De Bluefields and is connected to the mainland to the N by a narrow strip of land known as the Haulover. Red cliffs stand on the E side of the promontory. From seaward, the bluff has the appearance of an island. A light is located on the NE side of El Bluff. A small port facility lies on the NW side of promontory.

The lagoon entrance lies between Schooner Point, on the SW side of El Bluff, and Deer Point, on the N end of Isla del Venado. Cayo Casaba, a low and wooded islet with Isla San Demetri, a smaller islet located close W of it, lies in the middle of the entrance. The navigable channel is 0.1 to 0.2 mile wide.

On the bar extending S from Schooner Point, there is a limiting depth of 3.4m. It has been reported (2009) that recent dredging has increased the limiting depth to 4.2m. The recommended draft for vessels entering at LW is not more than 2.7m; however, vessels with a draft of 3.7 have entered at HW with a calm sea. Deep water in the harbor is confined to an area off the wharves that is 0.5 mile long and 0.1 mile wide. Depths in this area range from 5.5 to 6.2m. Elsewhere, the depths are less than 5.5m.

A wharf fronts the NW side of El Bluff. It is 183m long and has a depth of 6.1m alongside. The E end of this wharf has a berth, 114m long, which can accommodate vessels up to 3.7m draft. A steel floating berth, length 93m, has a depth alongside



Light on NE side of El Bluff



El Bluff Light

6.6m, Booth Dock, a T-head pier 122m long across the face, fronts the W side of El Bluff and is used only by small craft. It is reported (2009) that a group of derelict boats occupy this pier and renders it unusable. A dangerous stranded wreck encumbers the approach to Booth Docks.

In the approach to the port, the radio towers standing in the town of Bluefield are good landmarks.

The lagoon entrance lies between Schooner Point, on the SW side of El Bluff, and Deer Point, on the N end is Isla del Venado, Cayo Casaba, a low and wooded islet with Isla San Demetri, a smaller islet located close W of it, lies in the middle of the entrance. The navigable channel is 0.1 to 0.2 mile wide.

**Tides—Currents**—It has been reported (2009) that the tidal range is 0.4m; strong S currents, with velocities of 3 to 5 knots, have also been reported (2009).





Green pillar buoy between Cayo Casabe and El Bluff



Red nun buoy about 260m SW of Schooner Point

**5.30 Bluefields** (12°01'N., 83°45'W.) (World Port Index No. 9770) is situated on the W side of Laguna de Bluefields, 3.5 miles inside the entrance. The port for the town stands on the W and NW sides of El Bluff, where all cargo is handled and then lightered to the town by barge.

**Winds—Weather.**—From the middle of June through August, the NE wind is steady and very fresh raising a heavy sea and swell. The strong S current causes vessels at anchor to swing across the wind and roll and pitch uncomfortably. Rain is heavy and frequent, coming up in fresh squalls which follow closely upon one another.

From the first of September through October, the weather becomes variable with intervals of calms and frequent offshore winds. During this period heavy thunderstorms from the WSW are frequent.

From October, the wind begins to blow from the NE again accompanied by rain squalls and in early November it becomes stronger from the N with a considerable sea. At this time, the northers may be expected, which generally attain the greatest violence from NW to N.

**Tides—Currents.**—The current usually sets S off the entrance at a velocity of 1.5 to 2 knots, but at times it may reverse

itself at reduced strength for a day at a time for no apparent reason.

**Pilotage.**—Pilotage is compulsory. Pilots usually board about 0.5 mile seaward of El Bluff. Pilots can be contacted on VHF channel 16.

**Anchorage.**—Good anchorage can be taken, in a depth of 7m, about 1.5 miles S of El Bluff. The bottom is soft mud, with excellent holding ground. Vessels should use the starboard anchor because they will invariably lie heading N with the wind on the starboard bow. The anchorage area will be designated by the pilot.

Inside the bar, there is a good, though confined, anchorage, in a depth of 8m, close W of the wharf on the NW side of El Bluff.

### Bluefields to Punta de Perlas

**5.31 Blowing Rock** (12°02'N., 83°02'W.), 1.2m high and with a hole in its center through which water is occasionally forced like the spouting of a whale, lies 38 miles E of El Bluff.

A shoal, with a depth of 10.1m, is located 22 miles E of Blowing Rock. Another shoal, with a depth of 20m, lies 3.5 miles SW of Blowing Rock.

**Isla Grande del Maiz** (12°10'N., 83°03'W.), 2.5 miles long and 2 miles wide, lies 38 miles ENE of El Bluff. Mount Pleasant rises to a 113m wooded peak in the middle of the N part of the island. A 30m high, rocky, bluff stands at the S end of the island. The island is fringed by foul ground extending 0.3 mile to 1.5 miles offshore.

A wreck that lies stranded 1.3 miles NNE of the summit of Mount Pleasant is reported to be radar prominent.

Anchorage can be taken in Southwest Bay, on the SW side of the island, in depths of 8 to 9m; in Brig Bay, on the W side of the island, in depths of 9 to 11m; and in Long Bay, on the SE side of the island, in a depth of 9m. Care should be taken to avoid the reefs and shoal patches in or near these anchorages.

A pier, which is 98m long and has depths of 2.1 to 4m along-side, extends from the shore in the vicinity of a shrimp-processing plant at the head of Southwest Bay. This conspicuous building is lighted at night. A similar building, also lighted at night, stands at the head of Brig Bay.

**Isla Pequena del Maiz** (12°18'N., 82°59'W.), 0.5 mile long, 0.5 mile wide, and 38m high, stands 7.5 miles NNE of Isla Grande del Maiz. The N and E sides of the island are fringed by reefs extending 0.5 to 1 mile offshore. The W side of the island is fairly steep-to seaward of the 10m curve, which lies between 0.2 mile and 0.5 mile offshore.

Anchorage can be taken in Pelican Bay, on the SW side of the island, in a depth of 11m, with the W tangent of the island bearing 342° and the S tangent of the island bearing 106°.

**5.32** From El Bluff, the low and swampy coast extends 21 miles N to Punta Mosquito, the N entrance point of Laguna de Perlas. This lagoon is 1 to 6 miles wide and navigable only by boats.

Between El Bluff and Punta de Perlas, 6 miles E of Punta Mosquito, most of the coastal dangers are contained within the 10m, curve which lies between 1 mile and 4.5 miles offshore. Punta de Perlas, bordered by a white sandy beach, is a prominent projection when seen from the S.

## Cayos de Perlas

**5.33 Cayos de Perlas** (12°29'N., 83°19'W.) and several reefs lie between Punta de Perlas and a position lying 13.5 miles E. They extend 12 miles N. All of the cays and reefs lie within the 20m curve, which follows the irregular coastal trend in this vicinity a distance of 8 to 17 miles offshore. Several detached patches, with depths of 12 to 18m, lie up to 2 miles seaward of the 20m curve to the E of these cays.

Although there are depths of 11 to 18m in this area, navigation is very hazardous because of the numerous charted and uncharted reefs and shoals, some of which may not be visible because of the turbid waters. Although soundings in many places show a muddy bottom, it is only a thin covering over coral; tripping gear and a buoy should be used to prevent loss of the anchor.

It is evident that because of the dangers within these cays it is prudent to avoid them entirely and pass to the E.

**Seal Cay** (12°25'N., 83°17'W.), the southeasternmost of the Cayos de Perlas, is a small coral ridge 0.9m high, lying 12.5 miles E of Punta de Perlas. Foul ground extends 0.5 mile NW and 1 mile SSW from the cay, but the SE side is steep-to. Several 9m shoal patches lie within 1.8 miles S through about 4.5 miles SW of the cay.

The S limits of the Cayos de Perlas are marked by Columbila Cay, a steep-to reef-fringed islet, 33m high to the tops of the trees, lying 6.5 miles SW of Seal Cay. Maroon Cay, a similar islet on the edge of a reef extending 2 miles E from Punta de Perlas, stands at the SW extremity of these cays. Maroon Knoll, with a least depth of 5.5m, together with several detached 7.3 to 9.1m patches, lies up to 2.5 miles SSE of Maroon Cay.

**Boden Reef** (12°30'N., 83°19'W.), 0.8 mile long and with a least depth of 4.3m, lies on the E edge of the Cayos de Perlas, about midway between Seal Cay and the NE Cays 8 miles NW of Seal Cay. The NE Cays, a small group of reef-fringed islets with several rocks, awash, lying 1 mile NW, mark the NE extremity of the Cayos de Perlas. Numerous rocks, awash, and 3 to 5.5m patches lie up to 5 miles WSW of these cays.

Within the limits indicated above lie the Crawl Cays and the Tungawarra Cays, as well as numerous other small cays and shoals.

Although ample depths exist throughout the limits of the Cayos de Perlas, the numerous unmarked dangers and intricate channels make it advisable to pass well E of them.

Good anchorage can be taken about 0.3 mile SW of Little Tungawarra Cay. This anchorage should be approached from the S. Other anchorages may be found in the lee of the larger cays.

Two detached 7.3m depths and a shoal, with depths of 3 to 9m, lie 5 miles N of Cays de Perlas and between 4.5 miles and 8.2 miles offshore.

## Punta de Perlas to Puerto Cabezas

**5.34 Cayman Roca** (12°05'N., 83°39'W.), a small rock, 8m high and marked by a red conical tower, lies 6 miles NNE of El Bluff. False Bluff, a green mound, 18m high, stands on a small point of red bluffs about 12 miles N of El Bluff.

**Cerro Cucra** (12°15'N., 83°46'W.), isolated and 192m high,

rises 16 miles NNW of El Bluff and is a good landmark for the approach to Bluefields.

The **Rio Grande** (12°54'N., 83°32'W.) is navigable by barges up to 106 miles upstream. A depth of 1.5m exists on the bar at the entrance to the river. The village of Rio Grande is situated on the N bank of the river close within the entrance. A fruit station and a wharf lie on the S bank. Two radio towers standing on the S side of the entrance are conspicuous; the village of Sandy Bay, situated 3.5 miles N, is a fairly good landmark.

**5.35 Great King Cay** (12°45'N., 83°21'W.) is 21m high and the largest of a group of islets lying 12 miles N of the Cayos de Perlas and 9 to 13 miles offshore. Little King Cay, 10m high, stands 0.8 mile E of Great King Cay. Rocky Cays, two in number, lie 1 mile NW and Little Tyra Cay, 2.4m high together with a detached 3.9m patch, lie between 2 miles and 3 miles WSW of Great King Cay.

**Great Tyra Cay** (12°52'N., 83°23'W.), 18m high to the tops of the trees and with foul ground extending 0.5 mile N from it, is the largest of a group of islets and shoals which lie 8 miles N of Great King Cay. Seal Cay, two barren rocks 3m high, lies 0.8 mile S of Great Tyra Cay. A dangerous shoal patch lies 1 mile E of Seal Cay; several detached reefs lie between 1 mile and 3 miles SW of Great Tyra Cay. There are two detached shoals lying 1 mile and 5 miles NW of Great Tyra Cay.

Roca Tyra, 2.4m high and steep-to on its E side, lies 4.5 miles NE of Great Tyra Cay. Numerous detached reefs and shoals, over which the sea breaks, lie up to 3.5 miles W and 1 mile N of Tyra Rock.

**5.36 Cayos Man O War** (13°01'N., 83°23'W.), a cluster of islets, with the largest being 15m high, lies 11 miles offshore, 6.8 miles NW of Tyra Rock. An old oil barge, formerly used as a storage tank, stands on the W cay. A sheltered bight on the W side of this cay has pilings where vessels formerly moored to load lightered cargo. Depths alongside range from 4 to 6.7m.

Numerous detached reefs and shoals lie up to 3 miles SSW and WNW of Cayos Man O War. A 9.1m depth lies 5 miles WSW and two 9.1m depths lie 6 and 7 miles WNW of the cays. A coral head, with a depth of less than 7.3m, lies 2 miles W of Cayos Man O War.

**Egg Rock** (13°02'N., 83°22'W.), 1.8m high and steep-to, lies 1.4 miles NE of Cayos Man O War.

A dangerous shoal lies 13 miles NNW of Cayos Man O War.

**Caution.**—Many vessels have reported striking coral heads inside the 20m curve in the vicinity of Cayos Man O War and between them and Puerto Cabezas. It is advisable to keep seaward of the 20m curve when navigating along this part of the coast. A shoal, with a depth of 6.4m, lies about 49 miles SE of Puerto Cabezas.

**5.37 Puerto Isabel** (13°22'N., 83°34'W.), an open roadstead and a privately-owned port, is situated about 28 miles N of the Rio Grande.

**Tides—Currents.**—From March to April, the current sets in a N direction at a velocity of 1 to 2 knots; from May to February it sets in a S direction at the same velocity.

**Depths—Limitations.**—A pier, extending 0.5 mile E from the shore abreast of the town, has a berth, 76m long, situated at its outer end, with depths of 4.6 to 5.2m alongside. Vessels

berth port side-to on the S side of the pier, with their bows heading E, using the anchor and running a wire rope to a mooring dolphin off the head of the pier. Only vessels up to 4.6m draft can berth due to the heavy E swell. The N side of the pier is shoal.

**Aspect.**—Landmarks consist of the houses in the town, three oil tanks, and a conspicuous ore loader standing on the pier. Lighted range beacons, in line bearing 276°, are situated on the pier.

**Pilotage.**—No pilots are available and berthing is limited to daylight hours.

**Anchorage.**—Anchorage can be taken about 0.3 mile E of the pier head, in depths of 5.5 to 7.3m, hard sand, good holding ground.

**5.38** The **Rio Prinzapolca** (13°25'N., 83°34'W.), with a small village on its S bank, lies 10 miles N of Puerto Isabel. Shoal water, with depths of less than 1.8m, extends 1 mile E from the river mouth.

The **Rio Walpasixa** (Rio Hualpasixa) (13°29'N., 83°33'W.), with a village situated at its entrance, lies 4 miles N of the Rio Prinzapolca.

The sea breaks heavily on a bar at the river mouth. The village of Wounta stands on the S side of the entrance of a small lagoon located 4 miles N of the Rio Walpasixa. Foul ground extends about 3 miles E from a position just N of the lagoon entrance. Two shoals lie about 6 miles and 11 miles NNE of Wounta.

Several prominent mounds, each 24m high, stand near the coast 14 miles N of Wounta. From a position lying 11 miles N of the Rio Grande to a position E of these mounds, numerous dangers are contained within the 20m curve, but from there to Puerto Cabezas, it is comparatively free of charted dangers within the 10m curve, which lies 2 to 4 miles offshore.

The **Rio Wawa** (Rio Huahua) (13°53'N., 83°27'W.) discharges 21 miles N of Wounta. After heavy rains, muddy river water discolors the sea for some distance offshore. From the Rio Wawa, the coast extends 10 miles N to Bragman Bluff, a bold headland, 30m high, with red cliffs extending 0.5 mile along its E edge.

**5.39** **Puerto Cabezas** (14°01'N., 83°23'W.) (World Port Index No. 9760) consists of an open roadstead fronted by a pier extending SE from Bragmans Bluff. The principal exports are bananas and lumber.

**Tides—Currents.**—The current in the vicinity of the pier sets S or SSW at a velocity of 1.3 knots. Current signals are displayed at the head of the pier to facilitate berthing.

**Depths—Limitations.**—In the vicinity of the port, depths of 5.5m lie up to about 0.5 mile offshore and depths of 9m lie 1 to 2 miles offshore. Isolated depths of 8 to 9m are found outside the 10m curve, about 1.8 miles SE and 2 to 3 miles E of the bluff. A number of wrecks lie 0.3 to 0.7 mile E and ESE of the head of the jetty. They can best be seen on the chart.

Government Wharf extends 0.5 mile SE from the S extremity of Bragman Bluff. It is a wooden pier, 111m long and 20.0m wide, with a depth of 6.7m alongside the seaward end. Vessels up to 91m in length and 6.0m draft can be handled.

A sand bar, with a depth of 5.2m, was reported (1985) to lie close SW of the wharf.

**Aspect.**—Several water towers, the radio towers on the E side of the town, and several chimneys in its SE part are prominent landmarks.

At night, the glare of the lights in the town may be seen long before the navigational lights can be identified. The beach is reported to form a poor radar target, although the railroad cars on the siding are reported to be radar conspicuous. The pier is also reported to be radar conspicuous.



**Puerto Cabezas Light and Government Wharf**

**Pilotage.**—Pilotage is compulsory. Pilots will berth vessels only during daylight hours. An ETA should be sent 24 hours in advance. The pilot boards 1 mile off the port.

**Anchorage.**—Anchorage can be taken off the end of the pier, in depths of 6 to 9m, mud, good holding ground. Good anchorage can also be taken, in a depth of 8m, with the pier head bearing 319°, distant 0.4 mile. Care should be taken to avoid an obstruction lying 0.5 mile ESE of the pier head. There is practically no shelter from the wind and sea.

### **Puerto Cabezas to Punta Gorda**

**5.40** The coast between Puerto Cabezas and Punta Gorda, 23 miles NE, is low and wooded, with few distinguishing marks other than the mouth of the Rio Hueson, lying 8.8 miles NE of Puerto Cabezas. A prominent steeple stands 2.8 miles SW of the mouth of the Rio Hueson.

Most of the dangers that lie adjacent to this section of coast are contained within the 10m curve, which lies between 1 mile and 2 miles offshore. Some shoal patches, with depths of 7.3 to 10m, lie outside that curve, but within 2 miles of the shore. A narrow shoal, with a least depth of 7.3m, extends 1.3 miles S from a position located 2 miles SE of Punta Gorda.

The W edge of the reefs and other dangers, which are a part of the Cayos Miskitos, lies 7.5 miles E of Punta Gorda and extends SE to a position located 29 miles E of the mouth of the Rio Hueson.

**Punta Gorda** (14°21'N., 83°12'W.) is a low wooded point with almost no identifying features. About 5 miles NNW of the point, there is a conspicuous ridge, 7m high, which parallels the shore 1 mile inland for a distance of 2 miles. The 10m curve lies less than 1 mile offshore; there are depths of 14.6 to 20.1m in Miskito Channel between Punta Gorda and the W of the Cayos Miskitos, 7.5 miles E.

### **Cayos Miskitos and the Surrounding Cays and Reefs**

**5.41** From a position located 72 miles E of Punta Gorda,

the 200m curve extends NE to a position lying 92 miles E of Cabo Gracias a Dios. Inside this curve, the water of this part of Miskito Bank shoals rapidly to depths of less than 37m, and there are numerous patches and banks between it and the E edge of Cayos Miskitos, 40 to 50 miles offshore. The largest of these banks extends 12 miles N from a position lying 63 miles NE of Punta Gorda and is 6 miles wide. Between the cays and the mainland, most of the dangers are contained within the 10m curve, which follows the coastal trend between 0.5 mile and 4 miles offshore.

In the deep water off the edge of the 200m curve, the bottom is formed of fine sand, sometimes with a few broken shells, and on the E part of the Miskito Bank coral sand is prevalent with some coarser areas of small, flat, white stones. The bottom is generally rocky within small patches lying in depths of less than 18m.

The NE part of the bank consists of fine sand with small black specks and minute shells, which merges into blue mud as the cays are approached. In places, this bottom sediment becomes pale and so soft as to be washed off the sounding lead; near the cays it may be light gray in color. The beaches are formed of finely broken shells.

The numerous cays are small, with little or no vegetation, having been stripped by heavy seas and gales; however, some of the larger ones are wooded. Many of the cays and reefs are steep-to on the windward side, and there are numerous deep cuts which may provide sheltered anchorage.

**5.42** The Cayos Miskitos group, consisting of Cayos Miskitos and the surrounding cays and reefs, lies within a circle, with a radius of 19 miles, centered on the largest cay, 26 miles E of Punta Gorda. Approach to this area is dangerous from any direction because of the many detached reefs and shoals and the lack of any navigational aids.

**Cayos Miskitos** (14°23'N., 82°46'W.), the largest cays of the group, consists of one main island, 2.5 miles in diameter, with several smaller islands and islets lying adjacent to it and several others separated from it by a shallow lagoon. Cayos Miskitos, extending 5.5 miles NE, lies near the middle of the Cayos Miskitos group and in the center of the S half of a reef which extends 19 miles NNE from a position located 21 miles E of Punta Gorda. Porgee Channel (14°26'N., 82°41'W.), narrow and intricate, bisects the reef from E to W, about 0.5 mile NE of the NE island. To the N of the cays, the channel widens into a bay with depths of 12 to 18m.

**Blue Channel** (14°25'N., 82°50'W.), about 1.5 to 3 miles wide, has depths of 9 to 25m and runs parallel to the W side of Miskito Reef (14°28'N., 82°42'W.) and between it and the Morrison Dennis Cays, the Ualpatara Reefs (14°27'N., 82°58'W.), and others which extend 12 miles N.

**5.43 Hamkera** (14°34'N., 82°58'W.), a small group of islets and reefs, lies 15 miles NNW of Cayos Miskitos on the NW limits of the reef and the Cayos Miskitos group. From Outer Mohegan, the largest of the Hamkera group, numerous detached reefs extend about 3.5 miles N to several rocks awash.

**Auiapuni Reef** (14°31'N., 83°05'W.), a group of shoal patches 1.5 miles in extent, lies 7.5 miles SW of Outer Mohegan and at the W extremity of the Cayos Miskitos group.

Depths over this reef are 4.8 to 8.5m.

**Tsiankualalaia Rock** (14°20'N., 83°04'W.), with a depth of 2.7m, lies on the SW side of the Cayos Miskitos group, 7.8 miles E of Punta Gorda. Several rocks, with depths of less than 1.8m, lie within 0.5 mile S and SE of this rock. Waham Cay, 0.9m high, lies 3.5 miles NNE of the rock. Toro Cay and Kisura Cay, two similar islets, lie 2 miles NNW and 2 miles N, respectively, of Waham Cay.

Alice-Agnes Rocks, several rocks awash, with detached 7.3 and 8.2m patches within 1 mile of them, lie on the SW limits of the Cayos Miskitos group, 13 miles WSW of Cayos Miskitos and about the same distance SE of Punta Gorda.

**5.44 Ned Thomas Cay** (14°10'N., 82°48'W.) and The Witties lie in the center of a group of reefs about 8 miles in extent, 11.5 miles S of Cayos Miskitos. Sea Devil Reef, a 5.9m shoal patch, and Franklin Reef, a 4.6m shoal patch, lie on the S limits of the Cayos Miskitos group, 3.5 miles SW and 4 miles SSE of The Witties.

**Southeast Rock** (14°10'N., 82°29'W.), with a least depth of 2.7m, lies on a 10m bank 1 mile in extent, 19.5 miles E of Cayos Miskitos, at the SE extremity of the group. A 9.1m shoal patch lies 3 miles SE of the rock, and there are depths of 10m near the 20m curve, about 5.5 miles farther SE. A 4m shoal patch was reported (1975) to lie about 12 miles SE of the rock.

From Southeast Rock, the E edge of the Cayos Miskitos group extends 32 miles N to the NE extremity of the group, where a 6.7m shoal patch is located.

**Hannibal Shoals** (14°26'N., 82°31'W.), with a least depth of 7.6m, lie on the E edge of the Cayos Miskitos group, 13.3 miles E of Cayos Miskitos.

Within the described limits of the Cayos Miskitos group many other reefs and shoals exist, and although there are depths of 11 to 25m in the vicinity of these dangers, navigation throughout this area is difficult and dangerous.

**5.45 Edinburgh Reef** (14°50'N., 82°39'W.), 4 miles long and awash, lies about 8.3 miles N of the N limits of the Cayos Miskitos group. Edinburgh Cay lies detached about 1.5 miles WNW of the SW end of Edinburgh Reef. Edinburgh Channel, lying between Edinburgh Reef and the reefs to the S, is a clear passage with depths of 14 to 27m.

Cock Rocks, a group of several drying rocks 0.5 mile in extent, lies 4.5 miles N of Edinburgh Reef. A 7.3m shoal patch and a 12.2m shoal patch lie 2.5 miles E and 4 miles SE, respectively, of these rocks.

## Punta Gorda to Cabo Gracias a Dios

**5.46** Between Punta Gorda, described in paragraph 5.40, and Cabo Gracias a Dios, 39 miles N, the low coast is indented 7 miles W by a gradual bight. Several streams and rivers discharge along this coast and there are a few settlements.

Between Punta Gorda and Cabo Gracias a Dios, the normal set of the current over Miskito Bank is NW, at a velocity of 0.3 to 0.8 knot. In the vicinity of Cayos Miskitos, the set is more to the N, and between Kisura Cay and Ualpatara Reefs it sets N at a velocity of 1 knot. Inside the 20m curve and close to the coast, a countercurrent setting S may be experienced.

The currents near this coast are variable and at times may be

completely reversed.

**5.47** From Punta Gorda, the low coast extends 26 miles NNW to Laguna Huani, fronted by a shallow entrance 2 miles wide and partly obstructed by islands; the coast then extends 15 miles NE to Cabo Gracias a Dios. With the exception of a ridge 5 miles N of Punta Gorda, and the mouths of several shallow rivers, the coast is low, with few distinguishing marks other than groups of trees, 9 to 21m high.

The Sandy River, a narrow river leading into a lagoon, discharges 7 miles N of Punta Gorda; another river, the Rio Teikapalaga, discharges 13 miles farther NNW.

Most of the dangers are contained within the 10m curve, which lies 0.5 to 1 mile off the coast between Punta Gorda and a position 15 miles NNW, where it extends N to the cape and lies up to 4 miles offshore.

**Uatlatara Rocks** (14°34'N., 83°12'W.), two dangerous pinnacles with a least depth of 5.8m, lie 3 miles offshore, about 12.5 miles N of Punta Gorda.

Between the Rio Teikapalga and Cabo Gracias a Dios, there are numerous 9m shoal patches lying up to 1 mile outside the 10m curve. A bank, with a depth of 10.5m, lies 8.5 miles E of the Laguna Huani entrance. It is 4 miles long and 2 miles wide. A 9.1m shoal patch lies about 4.3 miles SE of Cabo Gracias a Dios.

The **Rio Coco** (14°59'N., 83°10'W.), which discharges on the S side of Cabo Gracias a Dios, is obstructed by several cays at its mouth. The bar has a depth of 1.8m, but this is subject to change because of silting.

**5.48 Cabo Gracias a Dios** (15°00'N., 83°10'W.), a small town, stands on the S side of the cape and is the seat of the governor. Timber and bananas are exported on vessels which call irregularly. Vessels desiring local assistance in sending a boat across the bar should proceed to a position E of the town and signal by whistle, light, or radio. They should then anchor close S of the bar to await the pilot.

Except for several radio masts standing in the town, the buildings cannot be seen by vessels approaching from the S due to heavy foliage.

## Cayos de Albuquerque and Cayos del Este Sudeste

**5.49 Cayos de Albuquerque** (12°10'N., 81°51'W.) lie 111 miles ENE of Punta Mono on a bank about 5 miles in extent. The edge of this bank is steep-to and has depths of 18m and less within the edge of the 200m curve. Numerous rocky heads and drying reefs exist, particularly near the E and S sides of the bank.

Cayo del Norte and Cayo del Sur, near the E side of the bank, are about 1.8m and 1.2m high, respectively, and have been reported to be radar prominent. Both cays have been reported to be heavily wooded with palm trees, 18m high. A light is shown from both Cayo del Norte and Cayo del Sur.

**5.50 Cayos del Este Sudeste** (12°24'N., 81°28'W.), 7 miles long and 2 miles wide, lie on a coral bank lying 24 miles ENE of Cayos de Albuquerque. A reef extends across the bank 1.5 miles within the N end. North and E of this reef the depths

range from 9 to 31m, coral and sand, to the edge of the bank. The E side of the reef is steep-to and extends 2 miles S to a bight indenting the E side. A broken reef continues S to about 1 mile within the bank's S extremity. Between this reef and the S end of the bank, the depths range from 11 to 23.8m, sand, coral and rock. The middle and W parts of the bank have numerous shallow patches. A stranded wreck lies on this reef, 3.3 miles NW of Cayo Bolivar Light.

Cayo del Este lies on the SE portion of the bank. The cay, about 0.3 mile long and 1.2m high, is thickly wooded with palm trees. Cayo Bolivar, 1.3 miles W of Cayo del Este, is 1.8m high with several palm trees on it. West Cay, 0.4 mile WNW of Cayo del Este, is very small and low. Cayo Arena is a small dry sand bank 1.3 miles NW of Cayo del Este. Huts have been erected on these cays by fishermen. Cayo Arena is reported to be radar conspicuous.

Anchorage can be taken on the W part of the bank, but only near the edge.

## Isla de San Andres

**5.51 Isla de San Andres** (12°33'N., 81°43'W.) lies 16 miles WNW of Cayos del Este Sudeste. It is about 7 miles long and 1.5 miles wide, and is marked by a ridge of hills extending from near its N end to within 1.5 miles of its S end. Three flat-topped summits rise above this ridge. These summits appear as only two hills when viewed from the N or S. A cliff at the N end of the ridge is distinctive. The island is reported to be radar conspicuous.

**Punta Norte** (12°36'N., 81°42'W.), the N extremity of Isla de San Andres, is fringed by foul ground which extends about 1 mile N from it. Blowing Rocks, low rocks over which the sea breaks heavily during N winds, lie 0.8 mile N of the point.

Cayo Johnny (Cayo Sucre), low, small, and covered by palm trees, lies on the NW end of a detached reef 1 mile ENE of Punta Norte. The coastal reef which lies 0.5 mile N and E of Cayo Sucre extends 4 miles S to a position about 1.8 miles ENE of Punta Sterthemberg. The S side of the reef is indented by a narrow irregular channel which leads N to Bahia de San Andres, 2.3 miles N. South of Punta Sterthemberg, the coastal reef nowhere lies more than 0.3 mile offshore. The W side of the island is steep-to and free of dangers.

**Punta Sur** (12°29'N., 81°44'W.), the S extremity of Isla de San Andres, is of moderate elevation, wooded, and marked by a light. The W side of the island is composed mainly of rocky cliffs and is indented 2.5 miles N of Punta Sur by Rada El Cove.

Temporary anchorage can be taken about 0.3 mile W and SW of the cove, in a depth of 13m, sand, but the swinging room is restricted. Although the holding ground is reported good, this anchorage is not recommended during the season of the northers.

The principal town is San Andres, situated on the N side of the island. A small pier used by lighters extends from the shore SE of the town. San Luis, a small village, stands S of Punta Sterthemberg.

On the N end of Isla de San Andres, the current generally sets strongly to the W, except during and after northers, when it sets S. This may be considered a locality where variable currents exist. It was reported (1959) that an unusual E set was ex-

perienced between Cristobal and Isla de San Andres.

**5.52 Bahia de San Andres** (12°35'N., 81°42'W.) is formed on its E side by the coastal reef extending S from Cayo Sucre and by the W side of Isla de San Andres.

**Depths—Limitations.**—A wharf, 300m long, is reported to have depths of 6.7 to 8.5m alongside. It lies parallel to the shore in the SW part of the bay. The channel leading to this wharf is entered about 2.3 miles S of the bay and is reported to be available to small vessels with drafts up to 4.6m.

**Pilotage.**—Pilotage is compulsory, but is available during daylight hours only. The pilot boards in the vicinity of Approach Lighted Buoy.

**Anchorage.**—Anchorage can be taken, in depths of 5.5 to 9m, in the bight at the entrance to the harbor. Anchorage can also be taken, in a depth of 11m, sand, SW of Cayo Cordoba (12°33'N., 81°41'W.).

**Caution.**—Shoal depths are reported (1997) to exist in the entrance to the bay.

## Isla de Providencia

**5.53 Isla de Providencia** (13°21'N., 81°22'W.) lies 50 miles NNE of Isla de San Andres. Together with Isla Santa Catalina, close off its N end, these islands extend 4.5 miles in a N-S direction. The mountainous center rises to three peaks of about the same elevation, the highest being 363m high. The islands lie on a bank, as defined by the 200m curve, that extends 10.5 miles N and 3 miles S from them. The N extremity of Isla de Providencia is Jones Point. On a spur extending S from this point stands Spit Hill, 168m high. From the NW or SE, a rocky chasm, about 18m wide and 24m deep, is prominent on Split Hill. Isla de Providencia is reported to be radar conspicuous.



Isla de Providencia Light from N

A reef lies within 2 miles of the E and S sides of the island and up to 8 miles N from its N side. Between the N end of the reef and the outer edge of the bank, about 2 miles N and 2.8 miles NE, there are general depths of 11 to 36m; between the S end of the reef and the edge of the bank, 1.8 miles S, the depths range from 7.3 to 95m. The W side of the island is foul, except for an

area about 1.5 miles in extent W of Catalina Harbor.

**Caution.**—A dangerous wreck exists about 3 miles SE of Isla de Providencia.

**Low Cay** (13°32'N., 81°21'W.), which shows a light, is located on the NW extremity of the reef 8.5 miles N of Jones Point. A reef, which dries in places, extends up to about 0.5 mile S from it.

Good anchorage can be taken 1 mile S of Low Cay, in depths of 11 to 18m, sand. Care should be taken to avoid the shoal patches in the vicinity.

Basalt Cay and Palm Cay, 0.3 mile N of Isla Santa Catalina, are small with moderate elevations. Palm trees stand on the latter island. A light is shown from Palm Cay.

**5.54 Catalina Harbor** (Bahia Catalina) (13°23'N., 81°23'W.), on the W side of the N part of Isla de Providencia, is 1 mile long and 0.5 mile wide. It provides sheltered anchorage to vessels with drafts up to 4.6m. The greater part of the harbor is shoal and depths of 5.5m and more can be found in a small area off the SW side of Isla Santa Catalina. Morgan Head, about 1.25 miles W of Isla Santa Catalina, is a prominent 12m high black rock.

**Isabel Village** (13°23'N., 81°22'W.), the chief settlement of Isla de Providencia, is situated close SE of Isla Santa Catalina.

**Anchorage.**—Sheltered anchorage from the prevailing winds can be taken, in depths of 5.5 to 8m, close SW of Isla Santa Catalina. Anchorage can be taken on the outer part of the bank, in a depth of 9m, with Morgan Head bearing 143° and the two small cays N of Isla Santa Catalina nearly in line bearing 094°. Anchorage can also be taken, in a depth of 11m, about 1.3 miles SW of the above anchorage on the outer part of the bank with Alligator Point, the W extremity of Isla de Providencia, bearing 168°, and the N extremity of Isla Santa Catalina bearing 072°. Isolated shallow depths may exist in this area.

**Caution.**—Caution must be exercised, as the depths have been reported to be as much as 0.6m less than charted. Strong and irregular currents exist in the vicinity of Isla de Providencia and should be guarded against by vessels passing through this area.

## Off-lying Dangers and Banks

**5.55** From a position lying 25 miles S of **Punta del Mono** (Monkey Point) (11°36'N., 83°40'W.), the 200m curve extends NNE to a position 28 miles E of that point, and then extends NNE to a position lying 72 miles E of Punta Gorda. This area is part of the Miskito Bank, which lies between the coast and the 200m curve to the E. A detached shoal, with depths of 10 to 18m, lies 65 miles ENE of Punta Mono and 8 miles E of the 200m curve.

The depths within the 200m curve are irregular and numerous cays, islands, and other dangers exist. In the E edge of the bank, depths of 36 to 55m will be found, but there are numerous 9 to 18m detached steep-to patches and some with depths as little as 1.8m. The greater part of the bank has depths of 24 to 33m. During a gale, the water over the fine sand or muddy bottom near the cays becomes turbid.

The turtle fishermen in this area know most of the rocks with depths of 11m or less, and are adept at estimating within 0.9m

the depth of a rock 1 mile distant. Under ordinary conditions, they can pilot a vessel at slow speed clear of all dangerous patches. In navigating over the bank, it is advantageous to have the observer aloft, the sun directly overhead, no haze or mist, and clear smooth water.

Coral reefs in these waters may grow about 6cm annually, and depths may be formed which are less than those charted.

Most dangers are contained within the 200m curve, which follows somewhat irregularly the coastal trend from 2 to 17 miles offshore between Punta Mono and a position 13 miles S of Puerto Cabezas.

A 9.1m shoal depth, located on a bank with depths up to 20m, about 4 miles in extent, lies 16 miles NE of Punta del Mono; a similar shoal depth lies 20 miles NNE of the bank.

**Caution.**—Great care is required when navigating in this area due to the unreliability and/or age of the surveys, the growth of reefs, and reports of new shoals.

**5.56 Roncador Bank** (13°34'N., 80°04'W.) lies with its N part located 75 miles ENE of Isla de Providencia. This very steep-to bank, as defined by the 200m curve, is 7 miles long and has a maximum width of 3.5 miles. Roncador Cay, composed of sand and blocks of coral, lies on the N part of the bank and is 4m high. With the exception of an area 0.5 mile wide within the E edge of the bank, where the general depths range from 9 to over 73m, the bank is covered by reefs, drying sandbanks, and coral heads. A light is shown from the N end of the bank. The SW part of the bank has more regular depths, but numerous coral heads and shallow depths lie scattered throughout the area. A conspicuous stranded wreck lies on the S end of Roncador Bank and has been reported to be radar conspicuous.

**Anchorage.**—Good anchorage can be taken on the W edge of the bank, in depths of 9 to 13m, but care should be taken to avoid the coral heads which are easily seen.

**Caution.**—A large area of discolored water, having the appearance of a shoal, was reported to lie 7 miles NW of Roncador Cay. In 1980, it was reported that a shoal, with a depth of 9.1m, was located 7 miles NNW of Roncador Cay

**5.57 Serrana Bank** (14°24'N., 80°16'W.), an extensive dangerous shoal area, lies with its SW end located 45 miles NNW of Roncador Cay. This steep-to bank is 20 miles long and 6 miles wide. All sides except the W and SW edges are fringed by a nearly unbroken reef. The sea breaking over the reef on the E side of the bank is visible for several miles farther than the cays which stand on it. Mariners are advised to use extreme caution when in the vicinity of Serrana Bank because of the strong currents. On the W and SW parts of the bank, there are numerous heads of live coral, with depths of only 1m. This part of the bank should be avoided by all except small craft with local knowledge.

**Southwest Cay** (14°16'N., 80°24'W.), composed of sand covered with grass and stunted brushwood, is 10m high and the largest cay on Serrana Bank. This cay has been reported to be radar conspicuous. A light is shown from the cay.

Eclipse Rock, a steep-to pinnacle with a depth of 4.6m, lies 0.4 mile WSW of Southwest Cay.

Temporary anchorage can be taken by small craft, in depths of 13 to 16.5m, about 0.6 mile NNW of Southwest Cay. A steep-to reef extends 9 miles NE from Southwest Cay, is par-

tially protected by the windward reefs and is not always visible. A 0.6m high ledge stands on the edge of the reef lying 6 miles NE of Southwest Cay. A drying sandbank lies 1.5 miles farther NE.

**North Cay** (14°28'N., 80°17'W.), located 13.5 miles NE of Southwest Cay, lies on the N end of the reef and is small and low. An object resembling a light pylon was reported to stand on or near this cay. It should not be mistaken for the light structure on Southwest Cay. A reef, which is only visible during N winds or strong trade winds, extends 3 miles from the cay in a SW direction. A stranded wreck was reported (1971) to lie 1 mile SW of North Cay.

Turtle fishermen visit this area from March to August. On occasion, the masts of their vessels and their temporary huts may be sighted before the reefs themselves.

**South Channel** (14°21'N., 80°15'W.), about midway along the SE side of Serrana Bank, is about 0.3 mile wide between the cays and fringing dangers which lie on either side. Depths in the fairway range from 7.3 to 12.8m. Care should be taken to avoid several 3.7m shoal patches which lie within the reef.

Temporary anchorage can be taken by small craft, in a depth of 8m, about 1 mile NE of the channel entrance or just within the entrance in a depth 12m about midway between the cays.

**East Channel** (14°21'N., 80°11'W.), 4 miles E of South Channel, is about 0.5 mile wide between the fringing dangers and has depths of 18.3 to 25.6m in the fairway. East Cay lies on the W side of the entrance and a spur of the reef extends about 2 miles N from it.

Anchorage can be taken by small craft, in depths of 13 to 16.5m, about 0.8 mile NE of East Cay.

The current sets in and out of South Channel and East Channel at a velocity of 1.5 to 2 knots.

An extensive bank, with a least known depth of 52m, was discovered (1973) lying about 25 miles ESE of Southwest Cay.

**5.58 Quita Sueno Bank** (14°15'N., 81°15'W.) lies with its S end located 39 miles NNE of Isla de Providencia and is very steep-to and dangerous. This bank, as defined by the 200m curve, extends 34 miles N and has a maximum width of 13.5 miles. Depths over this bank, exclusive of the 22 mile long reef which lies along its E side, range from 11 to 57m. From time to time, lesser depths have been reported to exist on this bank.

Good anchorage can be taken, in depths of 18 to 25m, clear sand and coral, W of the rocky ground that lies near the middle of the reef.

The two wrecks which lie stranded near mid bank are reported to be radar prominent. An additional stranded wreck lies in the SE corner of the reef.

**Caution.**—Great caution should be exercised by vessels passing E of Quita Sueno Bank, as the current here sets strongly to the W and on to the bank. Care is also required since the description of this area is based on inadequate surveys.

A detached shoal, with depths of 5.2 to 6.8m, lies about 14 miles WNW of the N edge of the reef. A vessel struck a coral head about 14 miles SW and a dangerous below-water rock is charted 19 miles SSW of the N edge of the reef. It seems probable that another unsurveyed reef exists W of Quita Sueno Bank. A shoal depth of 18.3m was reported (1964) to lie 38 miles WNW of Quita Sueno Light.

**5.59 Serranilla Bank** (15°55'N., 79°54'W.) lies 78 miles NNE of Serrana Bank. This bank, as defined by the 200m curve, is 24 miles long, 20 miles wide, and very steep-to. With the exception of the shoal area in the vicinity of the cays on the E and S parts of the bank, there are general depths of 9 to 37m.

There is no perceptible current on this bank, but a current generally sets WNW at a rate of 0.3 to 1 knot.

**East Cay** (15°52'N., 79°44'W.), the easternmost above-water feature on Serranilla Bank, is a small bush-covered cay, 2.1m high, that lies 3 miles W of the E edge of the bank. Foul ground, consisting of reefs and coral heads, extends 2.5 miles N through NE from the cay.

Northeast Breaker, a coral ledge with a rock, awash, on its S edge, lies 1 mile W of the edge of the bank, 3 miles NE of East Cay.

**Beacon Cay** (15°47'N., 79°50'W.), the largest of the three cays on the bank, lies 7.5 miles SW of East Cay, and is composed of sand and coral. This 2.4m high cay is covered with grass and is marked by a coral stone beacon on its W end.

A light is shown from Beacon Cay. A shoal, existence doubtful, with a depth of 2.2m, lies 5 miles S of the light.

There are numerous obstructions in the area lying N of a line joining East Cay and Beacon Cay, and within the limits of lines drawn 4.5 miles NW from each cay. A small 2.1m cay, Middle Cay, lies in this foul area almost 2 miles W of East Cay.

A 15.5m shoal, existence doubtful, is charted 36 miles SW of the light, midway between Serrana Bank and Rosalind Bank.

Good anchorage can be taken, in a depth of 11m, about 1 mile NW of Beacon Cay, but care should be taken to avoid the coral heads.

**West Breaker** (15°48'N., 79°59'W.), a dangerous breaking ledge about 0.6m high, lies almost 8 miles W of Beacon Cay and is the W danger on the bank. It has been reported (1985) that West Breaker extends 2 miles W of its charted position.

**5.60 Alice Shoal** (16°05'N., 79°18'W.), located NE of Serranilla Bank, with a least depth of 11m, coral, lies at the E edge of a circular bank about 10 miles in extent as defined by the

200m curve. Depths over the greater part of the bank are less than 36m. The bottom is fine white sand. Rips mark the edges of the bank.

Currents in the vicinity of the bank attain a velocity of about 2 knots. An observation of short duration taken at the E edge of the bank revealed a set NE at a velocity of 1 knot with light ESE breezes. This current probably is a countercurrent that sets across the bank.

A depth of 96.9m was reported (1973) to lie 6 miles ESE of the E extremity of Alice Shoal. Unconfirmed reports (1983) indicate that depths on the W part of Alice Shoal may be considerably less than charted.

**Bajo Nuevo** (New Bank) (15°53'N., 78°33'W.), about 5 miles wide, is 14 miles long. It has been reported (1967) that Bajo Nuevo has extended W to about position 15°48'N, 78°55'W. The bank has not been completely examined and its SW end is not well defined. The NW side of the bank is clear of known dangers. Depths of 3.7m are reported to extend up to 10 miles W of Bajo Nuevo. Seals gather on the reefs of the bank and are hunted in March and April. East Reef and West Reef, consisting of numerous rocky heads and separated by an opening about 0.5 mile wide, extend along the SE side of the bank. They are over 2.5 miles wide and steep-to on the SE and N sides. Sand accumulates on the reefs and forms low ridges, barely awash. At times these wash away. A stranded wreck, which is reported to be radar conspicuous, lies at the NE end of East Reef. Another stranded wreck lies on the W end of West Reef.

**Low Cay** (15°52'N., 78°39'W.), 1.5m high and barren, lies at the N end of West Reef. It is composed of broken coral, driftwood, and sand. In moderate weather, exposed anchorage can be taken, in depths of 12 to 14m, sand and coral, about 1.5 miles W of Low Cay. The anchorage should be approached from the W. Care must be taken to avoid a 3.7m coral head that lies 2 miles WSW of the cay and the foul ground between. The current in the vicinity of the bank sets W and SW and attains a velocity of 2 knots.

Bajo Nuevo Light is shown from a tower standing on Low Cay.



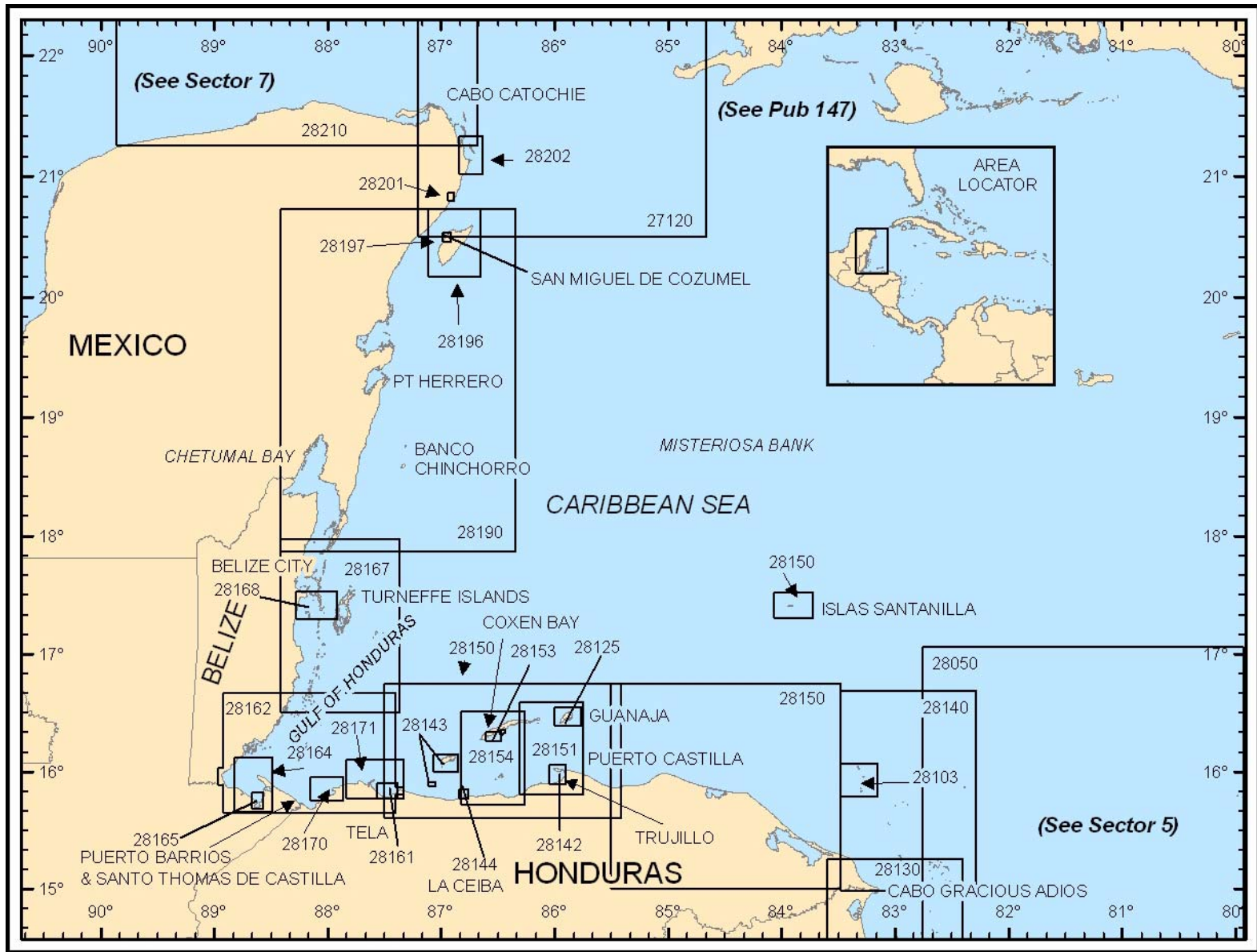

Additional chart coverage may be found in NGA/DLIS Catalog of Maps, Charts, and Related Products (Unlimited Distribution).

**SECTOR 6 — CHART INFORMATION**

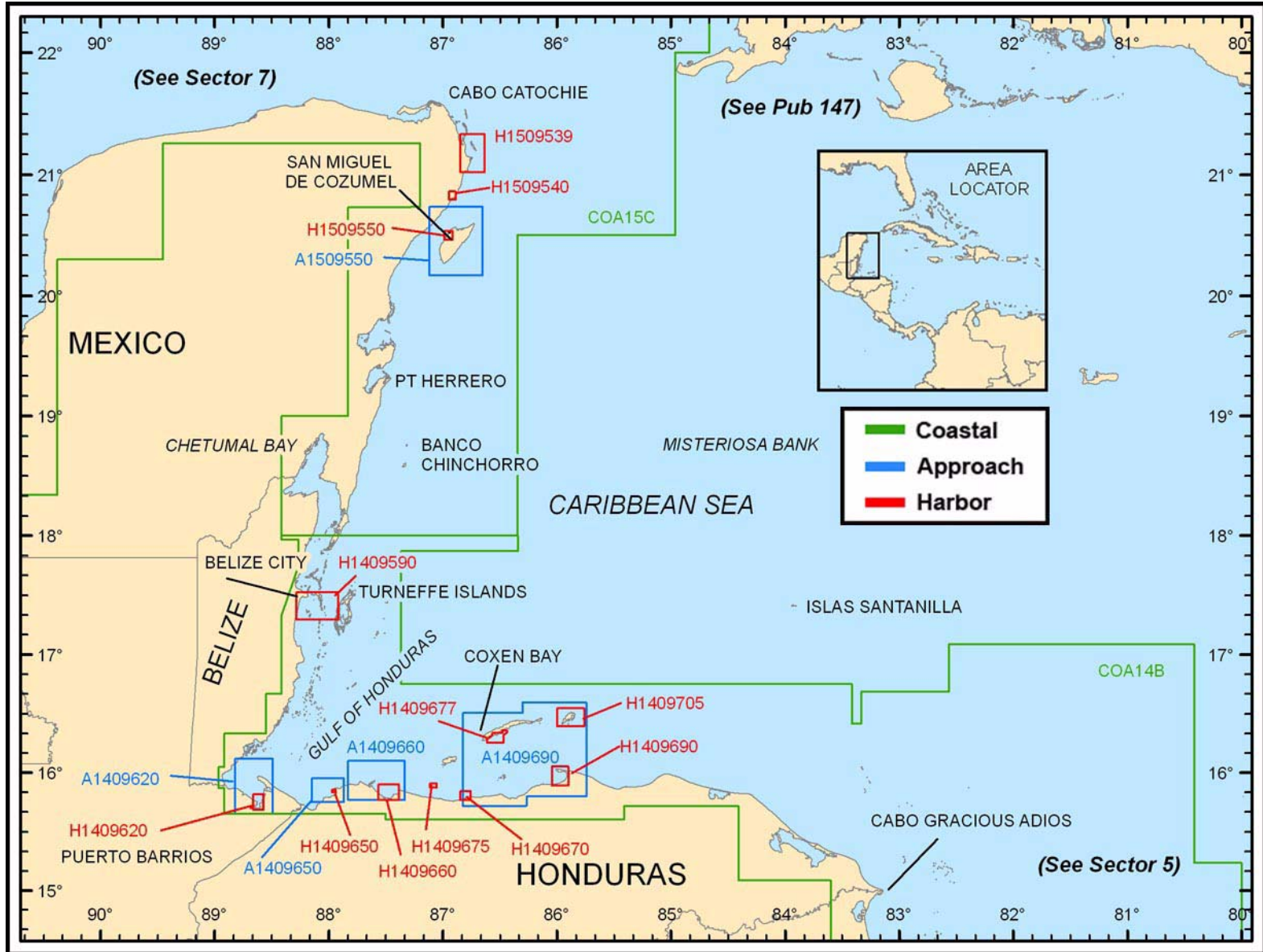

Additional DNC library coverage may be found in NGA DNCs 14 and 15 (Limited Distribution) disc within the README\GRAPHICS folder.

**SECTOR 6 — DNC LIBRARY INFORMATION**

## SECTOR 6

### COASTS OF HONDURAS, GUATEMALA, BELIZE, AND MEXICO—CABO GRACIAS A DIOS TO CABO CATOCHE

**Plan.**—This sector describes the Caribbean coasts of Honduras, Guatemala, Belize, and Mexico from Cabo Gracias a Dios to Cabo Catoche. It includes the off-lying islands, banks, and other dangers. The descriptive sequence from Cabo Gracias a Dios is W, then N.

#### General Remarks

**6.1** The coasts between Cabo Gracias a Dios and Cabo Catoche, 450 miles NW, together with the off-lying islands, banks, and other dangers are described in this sector. The coast between Cabo Gracias a Dios and the W head of Bahia de Amatique, 345 miles WNW, extends 130 miles NW to Cabo Camaron and then 235 miles W to the head of the bay. The coast of Honduras comprises 320 miles of this coast and the coast of Guatemala comprises the remaining 45 miles. The coast is generally low, swampy, and fronted by sandy beach. Cays and banks extend offshore up to 72 miles E, through N, from Cabo Gracias a Dios. Those banks and islands which lie seaward of the 200m curve are described separately under off-lying depths and dangers.

An irregular chain of mountains, Sierras La Cruz, rises abruptly from the lowlands about 10 miles S of Cabo Camaron and extends along the entire W part of this coast. This range reaches the coast in some localities and in others recedes up to 20 miles inland.

Few navigational lights are shown along this coast. Several peaks of the above-mentioned range are prominent landmarks in this area.

The principal ports within this area are Puerto Castilla, La Ceiba, Tela, and Puerto Cortes in Honduras and Puerto Barrios and Santo Tomas de Castilla in Guatemala. Few sheltered anchorages are to be found along this section of coast.

The coasts of Belize and Mexico extend NNE for a distance of 375 miles from the head of Bahia de Amatique to Cabo Catoche, the NE extremity of Peninsula de Yucatan. This coast, with the exception of the S part, is low and offers few prominent landmarks to the offshore navigator. The coast of Belize, a distance of 165 miles to the Mexican boundary, is indented in several places by shallow bays.

This coast is fronted by a barrier reef that lies up to 22 miles offshore, and by cays and reefs which lie up to 45 miles offshore. The cays and reefs are of the most dangerous type, as they are low and very steep-to. The Mexican part of the coast, formed by the E side of Peninsula de Yucatan, is generally steep-to and clear of off-lying dangers with the exception of Banco Chinchoro, 25 miles E of Majaqual, and the banks and dangers off the N part of this coast between Puerto Morelos and Cabo Catoche. Lights are shown on the principal off-lying islands and dangers and on some of the principal points along the coast. The major port within this area is Belize City, Belize. There are several good anchorages off this coast.

**Winds—Weather.**—The winds along the Honduran coast

are E throughout the year, with a pronounced diurnal variation in the late night and early morning calms, and light offshore winds are frequent. During the day and into the night, the trade winds are prevalent, sometimes attaining considerable strength in the afternoon.

Seldom do strong winds blow in the early morning, except during the months of November and December. Nearly every year during these months, there are a few days with N winds of gale force and with heavy rain continuing throughout the 24 hours.

Rainfall is plentiful throughout the year, with a maximum in November and a minimum in March through May. The amount increases from E to W.

The climate is hot and humid, with the temperature ranging from 23°C in January to 27°C in May.

Along the coast of Belize, the prevailing winds or trades are E or SE. They reach their gales and constancy in July. The velocity of the trade wind averages 10 to 13 knots, but frequently increases to 30 knots or more.

From October to January, N winds predominate and the average velocity is slightly lower. Northers are quite frequent during these months.

The diurnal variation as observed at Belize City is not nearly as evident at Tela, Honduras, although there is some acceleration during the day due to the sea breeze and some deceleration during the night and early morning due to the land breeze.

Tropical cyclones that form in the W Caribbean during June, late September, October, and early November do not as a rule attain sufficient strength to be damaging until they have passed Belize. Of those which form in the Atlantic and pass through the Caribbean, occasionally one may follow a more S course and pass inland. A well-developed storm of this type may cause great damage. The hurricane of September 10, 1931, which passed through Belize, is an outstanding example of this type. It was reported that as a result of Hurricane Mitch (1998) all navigational aids along the Honduran coast have either been destroyed or are unreliable. Local authorities should be consulted.

Rainfall is abundant throughout the year, with the least amount falling in March, April, and May. The amount increases from N to S, averaging 1,252mm at Corozal and 4,290mm at Punta Gorda.

The climate would be very oppressive were it not for the prevailing winds which blow off the sea during the hot months. May to September are the warmest, with an average of temperature of 27°C; December and January the coolest, with an average temperature of 23°C.

#### Off-lying Banks and Islands

**6.2** The 200m curve lies up to 134 miles ENE of Cabo Gracias a Dios, then extends 105 miles NW to a position lying 125 miles NE of the cape. From this position, it extends SW to-

ward the coast to a position lying 18 miles N of Punta Patuca. This area contains numerous cays, reefs, and other dangers and is generally known as the N part of the Miskito Bank.

The 200m curve, from its position N of Punta Patuca, extends 104 miles W to a position lying 8 miles N of Punta Caxinas.

The outer edge of the 200m curve is steep-to on all sides and contains general depths of 18 to 64m within its limits. In the deep water off the edge of the bank, the bottom is mostly coral sand with a few small broken shells. The E and NE parts of the bank have similar bottoms. In the vicinity of small patches, where the depths decrease to less than 18m, the bottom is generally rocky. As the cays are approached, the bottom changes from fine sand and minute shells to blue mud. Nearer the cays, this bottom has been reported to be of a light gray color which is easily agitated.

The numerous cays on the bank are small and have little or no vegetation. In heavy weather, the sea breaks completely across them. The cays and reefs are generally steep-to on the windward side, but slope gradually on the lee side. When navigating over the bank, it is advantageous to have an observer aloft, the sun directly overhead, the sea clear and smooth, and no haze or mist.

**Caution.**—Coral reefs in this region have been known to grow at a rate of about 6cm annually, and depths less than charted may be encountered. Seaward of the 200m curve, which defines the limits of the N part of Miskito Bank, there are several banks and two small islands which lie NE, N, and NW of Cabo Gracias a Dios. These dangers are described first, followed by a description of the dangers within the 200m curve.

**6.3 Rosalind Bank** (16°26'N., 80°31'W.) lies with its S extremity located 167 miles ENE of Cabo Gracias a Dios. This bank, as defined by the 200m curve, is 63 miles long and 35 miles wide. General depths range from 18 to 37m, coarse sand and coral.

Several 7.3 to 11m patches lie on a 14 mile long coral ledge located 2 miles within the SE edge of the bank. A detached 11m patch lies near the SW edge of the bank, 13.5 miles WNW of the S end of this ledge. A depth of 10.9m, first reported in 1983, lies close to the N edge of the bank.

**Tides—Currents.**—The current generally sets NW at a velocity of 1.5 knots over Rosalind Bank. On striking the ledge near the SE edge, it causes a race which has the appearance of breakers.

**Caution.**—An extensive bank, 41 miles long and 10 miles wide, lies 11 miles W of Rosalind Bank. Depths over this bank range from 7 to 66m. The shallowest detached patches are found along the E edge of the bank. A detached 11m patch lies on the N part of the bank. A wreck lies on the E side of the bank near position 16°21'N 80°20'W.

**Thunder Knoll** (16°27'N., 81°20'W.), about 11 miles in extent and composed of coral sand, lies 4 miles W of the N part of Rosalind Bank. Depths over this bank range from 11 to 27m. Two detached shoals, with depths of 12.8 to 15.5m and 35 to 37m, lie between 4.5 miles and 8.5 miles W of Thunder Knoll. A detached 11m patch was reported to lie about 4 miles SW of the SW part of Thunder Knoll. It is reported that a least depth of 7.3m exists in the vicinity of Thunder Knoll.

**6.4 Islas Santanilla** (Swan Islands) (17°25'N., 83°56'W.), located 150 miles NNW of Cabo Gracias a Dios, are two small islands lying close together near the W part of a narrow bank about 18 miles long. The E island is 1.5 miles long, 18m high, and has a bold rocky shore. The island is densely covered by trees and bushes. The W island is 1.8 miles long and flat, and covered also by trees about 18m high. A Honduran Navy post and a cattle farm exist on the SW end of the W island. A narrow foul passage separates the two islands.

Islas Santanilla have been reported to be radar conspicuous. A light with an aeronautical radiobeacon stands on the NW side of the W island.

**Pilotage.**—Pilotage is not compulsory, but pilots are available, if requested, both by day and night, about 0.5 mile offshore.

**Anchorage.**—Anchorage can be taken, in a depth of 12m, off the sandy bay at the W end of the W island.

It is necessary, in fair weather, to select a clear berth, which can easily be done by eye, but the NW extremity of the island must not be brought to bear more than 054° in order to avoid the foul ground on the N edge of the bank, which has a depth of about 8.2m

During N winds, sheltered anchorage can be taken close inshore S of the W end of the island; during S and SW gales, anchorage can be taken N of the island, nearer the E than the W end.

**Caution.**—A bank, with depths of 27 to 91m, extends about 13 miles E from a position about 44 miles SE of Islas Santanilla. In 1972, a 8m patch was reported to lie about in the center of this bank.

**6.5 Misteriosa Bank** (18°51'N., 83°50'W.), about 24 miles long and from 2 to 7 miles wide, lies centered about 87 miles N of Islas Santanilla. Depths over this reddish coral bank range from 12.8 to 49m.

**Rosario Bank** (18°30'N., 84°04'W.), about 10 miles in extent, lies about 62 miles N of Islas Santanilla and has depths of 18 to 64m.

In the general vicinity of the above two banks, there are several other small banks and patches, with depths ranging from 20 to 64m. A detached 7.3m patch was reported to lie about 6 miles E of the E side of Rosario Bank.

**Arrecife de La Media Luna** (Half Moon Reef) (15°13'N., 82°38'W.) has its N extremity about 34 miles ENE of Cabo Gracias a Dios and forms the N end of a group of reefs and cays which lie on a bank, as defined by the 20m curve, extending 20 miles S to Cock Rocks. This bank has a maximum width of about 11 miles, 6 miles S of its N end. Logwood Cay (Cayo Modera) stands on the W side of Arrecife de La Media Luna.

Cayo Media Luna (Half Moon Cay) lies about 2.5 miles S of Logwood Cay; a crescent-shaped reef extends about 0.5 mile E and then 0.8 mile N from it. A coral patch, with a least depth of 8.2m, lies about 2.5 miles E of Cayo Media Luna.

A coral patch, with a least depth of 12.8m, lies 7 miles NNW of the N end of Arrecife de La Media Luna. A 7.3m detached patch was reported to lie close W of the 12.8m patch.

Bobel Cay stands about 4 miles SSE of Cayo Media Luna, and Hall Rock, with a depth of 6.4m, lies about 2.5 miles farther SSE. Two cays stand close together between 6.3 miles and 7 miles ESE of Cayo Media Luna. Several rocky heads lie in

the vicinity of these cays.

Savanna Cut, a narrow passage with depths of 11 to 18.3m, lies between Arrecife de la Media Luna and Savanna Reefs (15°10'N., 82°25'W.), about 5 miles E.

South Cay, an isolated cay, lies 6 miles SW of Savanna Reefs. Isolated rocks lie 4 miles ENE and 2 miles WNW, respectively, from South Cay.

Alargate Reef (Arrecife Alagardo), the E visible danger on Miskito Bank, lies about 5 miles E of Savanna Reefs. The sea breaks heavily on this reef. During the season of fresh NE winds, there is often a strong set toward the E side of the reef, which adds considerably to its danger. It has been reported (1986) that Alargate Reef lies 2 miles E of its charted position.

**6.6 Banco del Cabo** (Main Cape Shoal) (15°16'N., 82°57'W.), nearly awash in places and steep-to, lies about 17 miles NE of Cabo Gracias a Dios. This shoal is about 4 miles in length, but the sea seldom breaks over it. The discolored water may be seen from aloft in clear weather.

Main Cape Channel, the passage between Banco del Cabo and Arrecife de La Media Luna, is clear of known dangers and has general depths of 18 to 29m.

A 7.3m patch was reported in 1970 to lie about 13 miles NE of the N end of Banco del Cabo.

**Gorda Bank** (15°36'N., 82°13'W.), with depths of less than 20.1m, extends about 52 miles NW from a position about 18 miles ENE of the NE extremity of Alargate Reef. Lesser depths than charted may exist on this bank. The bottom is clearly visible. On its N side there are a number of patches of flat coral, covered with dark weed, but the depths appear to be regular. Vessels of deep draft should avoid this bank.

In 1981, lesser depths than those charted were reported between position 15°40'N, 82°08'W and position 15°07'N, 82°00'W. Also in 1981, a depth of 10.1m, whose position is approximate, was reported to lie about 14 miles N of the S extremity of Gorda Bank.

**Cay Gorda** (15°52'N., 82°24'W.) stands on the N edge of Gorda Bank. This barren cay is 4m high and composed of sand, broken coral, and large stones. A reef extends about 1.8 miles NW from it, but its E and S sides are steep-to.

**Caution.**—A stranded wreck lies about 4.8 miles WSW of Cay Gorda.

**6.7 Farrall Rock**, 5 miles E of Cay Gorda, breaks only in heavy weather and can be identified by its dark appearance, in contrast to the white sandy bottom of the bank on which it lies. The two parts of the stranded wreck near the rock were reported to be radar prominent.

**Bancos del Cabo Falso** (False Cape Bank) (15°32'N., 83°03'W.), a dangerous steep-to breaking bank, lies about 32 miles NNE of Cabo Gracias a Dios. A 16.4m patch was reported to lie 9 miles SSW of the S end of Bancos del Cabo Falso.

**Cayos Cocorocuma** (15°43'N., 83°00'W.), a reef about 5 miles long and convex-shaped to the E, lies about 44 miles NNE of Cabo Gracias a Dios. A detached coral patch that breaks lies about 0.8 mile W of its N end. A group of seven small cays, not over 0.6m high and about 1 mile in extent, lie on the S end of the reef. The S and largest cay is covered with bushes and some coconut trees on its E end. Another cay, about 1 mile N of this cay, has a square clump of brushwood, about

4.6m high, which resembles an isolated rock when seen from a distance.

**6.8 Cayos Pichones** (Pigeon Cays) (15°45'N., 82°56'W.), two in number, lie 3 miles E of Cayos Cocorocuma. The W is a small islet at the S end of a dangerous steep-to half-mooned reef, about 0.8 mile in extent, over which the sea breaks in heavy weather. A steep-to reef lies about 2.8 miles SE of this islet.

**Banco Vivorillo** (Vivarrio Bank) (15°54'N., 83°22'W.), a coral bank about 10 miles long, lies with its NW extremity about 59 miles N of Cabo Gracias a Dios. Depths over this bank range from 2.7 to 10m.

**Cayos Vivorillo** (Vivarrio Cays) (15°50'N., 83°18'W.) consist of several tree and bush-covered cays which lie on a coral reef at the SE end of Banco Vivorillo. A light stands at the SE end of this reef. A continuous line of breakers front the steep-to E side of the reef. Practically all of this reef is usually dry or just awash.

A coral ledge, with a depth of 9.6m, lies about 22 miles W of Cayos Vivorillo.

**Cayos Becerro** (15°55'N., 83°16'W.), about 5.5 miles NNE of Cayos Vivorillo, consists of eight small cays lying on a coral ledge about 3.5 miles long and 1 mile wide. The sea always breaks along the E and N sides of this reef. Grand Becerro Cay, the largest cay, consists of two parts and stands near the S part of the ledge. This cay is covered with mangroves and a conspicuous palm tree stands on its W side.

El Becerro, a rock over which the sea usually breaks, stands 1.2 miles SE of the largest cay, mentioned above, on a coral reef with depths of 3.7 to 9m. Several 16.5m patches lie within 1.5 miles E of this rock. Rocky pinnacles, with a depth of about 9m, lie 5.5 miles NNE of El Becerro.

Hannibal Banks, two small shoals about 0.8 mile apart, lie in the SE part of the passage which lies between Cayos Vivorillo and Cayos Becerro. The N shoal has a least depth of 10.4m while the S shoal has a least depth of 12.8m.

**Cayos Caratasca** (16°02'N., 83°20'W.) consist of a group of seven small cays which lie in about the middle of a shoal bank, about 9 miles NW of Cayos Becerro. The S of these cays has some vegetation, but the others are barren.

**6.9 Cayos Cajones** (Drawers) (16°06'N., 83°13'W.), a steep-to reef about 13 miles long in an E and W direction, lies centered about 11 miles N of El Becerro. The narrow W part nearly always dries, but it does not always break. A small cay, with bushes and coconut trees, stands about 3 miles W of the E end of the reef. A 7m patch was reported (1970) to lie about 5.5 miles NW of the middle part of Cayos Cajones. Another patch 9.1m lies about 6 miles S of the same part of this reef.

**Caution.**—Too much care cannot be taken when approaching Cayos Cajones. Vessels approaching from the N, at night or in hazy weather, should not venture into depths of less than 55m. Depths of 37m may be found about 4 miles off the reef. It is reported that seaward of this depth, the bottom consists of mud, while inside this depth, the bottom consists of coral and sand. Off the NW end of Cayos Cajones, the mud is reported to be so soft that it is difficult to even obtain a sample of the bottom.

During the season of fresh NE winds, there is often a strong

set toward the N side of Cayos Cajones, which adds considerably to the danger.

A coral ledge, about 5 miles wide and 7 miles long, lies about 26 miles ENE of Punta Patuca and has general depths of 12.8 to 16.5m. A 10m patch lies in the center of this ledge.

### Cabo Gracias a Dios to Punta Patuca

**6.10 Cabo Gracias a Dios** (15°00'N., 83°09'W.) is low, swampy, and covered with trees. The radio masts, up to 46m high, which stand close W of the disused lighthouse are the best landmarks in this area during the day.

**Caution.**—Lesser depths than charted have been reported to lie 4 miles SE and between 4 miles and 10 miles E of the cape. Vessels should stay at least 10 miles from the cape and, in thick weather, should keep in depths of more than 18m.

Between Cabo Gracias a Dios and Cabo Falso, about 16 miles NW, the coast is low, swampy, and covered with stunted trees and brushwood.

**Cabo Falso** (15°12'N., 83°20'W.) is a low point backed by several isolated trees and brushwood. It should be approached with caution as a hard sand bank, with depths of less than 5.5m, extends about 3 miles NE from it; the sea usually breaks over this bank and the inner part dries in places. The 10m curve lies about 6.5 miles NE of Cabo Falso.

**Caution.**—The area in the vicinity of Cabo Falso has not been thoroughly examined and passing vessels should give it a wide berth.

The Rio Cruta, lying about 3.5 miles NW of Cabo Falso, is marked at its shallow mouth by high trees which have the appearance of a bluff. When viewed from the W they may be mistaken for Cabo Falso. In 1973, the mouth of the river was easily identified by radar.

A light is shown from the mouth of the river.

**6.11 Punta Patuca** (15°49'N., 84°17'W.), a low prominent point, lies about 64 miles NW of the Rio Cruta. The coast presents the same low general aspect as the coast SE of the Rio Cruta.

The entrance to the Laguna Caratasca lies about 27 miles WNW of the Rio Cruta and can be identified by a large group of 27m high trees on either side. This large fresh water lagoon parallels the coast for about 35 miles and is separated from the sea by a narrow low thinly-wooded ridge of sand. In 1973, the prominent point on the E side of the entrance to Laguna Caratasca was reported to be radar prominent.

Estero Tabacunta, the W outlet for the Laguna Caratasca, lies about 28 miles NW of the above entrance. Both entrances are fronted by shallow bars, but the latter entrance has a channel with a depth of 1.8m. Low white sand cliffs in the vicinity of Estero Tabacunta serve to identify this part of the coast.

The Rio Patuca lies about 9 miles NNW of Estero Tabacunta; Punta Patuca is the W entrance point. The river, about 150 miles in length, is one of the largest rivers in Honduras.

The mouth of the Rio Patuca is about 200m wide, but is difficult to make out unless a vessel is close-in. A light stands at the mouth of the Rio Patuca. The depth over the bar is about 1.8m during the dry season, and from 2.4 to 3m during the wet season. The outgoing current, even during the dry season, attains a rate of 1.5 knots. The only landmarks are a series of

light-colored bluffs which stand SE of the river mouth and a low, rounded hill in which the land to the E seems to end. The E entrance point of the river is low and sandy.

### Punta Patuca to Punta Caxinas

**6.12** The coast between Punta Patuca and Cabo Camaron, about 44 miles WNW, is low, thickly wooded, and fronted by a sandy beach.

**Cerro Payas** (Poyas Peak) (15°45'N., 84°56'W.), a 1,128m peak, rises abruptly from low land about 37 miles W of Punta Patuca and forms the E end of the Sierras La Cruz, an irregular mountain chain. This peak is frequently obscured by clouds, but Pico Panoche, 625m high, about 5 miles to the N, is usually visible. A vessel proceeding W will sight these peaks soon after passing Punta Patuca. The entrance to the Laguna de Brus is located at the W end of the lagoon, about 22 miles W of Punta Patuca, and is marked on its W side by a clump of trees higher than those elsewhere in the vicinity. The entrance is difficult to make out from seaward. The bar across the entrance has depths of 1.8 to 2.1m during the dry season and is usually fronted by heavy breakers. There are depths of 3 to 3.4m within the lagoon, but there are many shoals and shallow depths.

The Rio Sico discharges into the sea about 16 miles WNW of the entrance to the Laguna de Brus. The bar which obstructs its entrance has a least depth of 1.5m in the dry season and as much as 2.7m in the rainy season, and is only passable by boats during moderate weather. The land rises abruptly on both sides of this river and the mountains approach fairly close to the coast. The flat, swampy part of Honduras ends here and the land to the W is traversed by numerous ridges, which reach the coast in places.

**6.13 Cabo Camaron** (16°00'N., 85°00'W.), marked by a light, which lies about 5 miles WNW of the Rio Sico, is a low, rounded point topped by trees 24m high. The land is flat for some distance inland.

Because of the low sand bars on either side of the rivers between Cabo Camaron and Punta Caxinas, approaches are advised only for small boats assisted by local knowledge.

The coast between Cabo Camaron and the Rio Aquan, about 42 miles W, is indented by a bight that extends about 6 miles S. The E part of the bight is low and sandy and the W part is a low thinly-wooded beach topped by some sand hills, 12 to 18m high.

From Cabo Camaron, the coast trends about 15 miles WSW to Piedracito, a small, distinctive rocky bluff, and then about 11 miles W to Cabeza Piedra Grande.

Iriona, a small settlement, stands 8 miles SW of Cabo Camaron. Iriona is the seat of government for the territory E to the Nicaraguan border.

A lower ridge of mountains rises S of Iriona and extends W to a position close S of Cabeza Piedra Grande.

From a position about midway between Cabo Camaron and Piedracito, as far W as Cabeza Piedra Grande, the lower slopes of the mountains inland nearly reach the coast.

**6.14 Cerro Sangrelaya** (15°52'N., 85°09'W.), 1,875m high, stands about 5 miles SE of Piedracito; a conical peak, 960m high, rises 7 miles S of the same point. A saddle-shaped

summit stands about 5 miles SW of the latter peak.

**Cabeza Piedra Grande** (15°54'N., 85°29'W.) is a rocky bluff about 122m high. From Cabeza Piedra Grande, the coast trends about 35 miles WNW to Punta Caxinas (16°02'N., 86°01'W.), which shows a light, and is located at the W extremity of Cabo de Honduras, which is a narrow neck of low land about 5 miles in length. The cape is bordered by a beach with some scattered scantily-wooded sand hills, 12 to 18 high.

Depths of 73m are found up to 17 miles offshore along the middle of this stretch of course, which then decrease to 18.3m about 3 miles offshore; the soundings are sparse. Within 17 miles of Cabo de Honduras, the depths become irregular, with shoals between 9.1m and 18.3m to the NE, 17.4m to the N, and 9.1 to 17.2m to the NW of the Cape.

The mountain range S of Cabeza Piedra Grande extends W for about 14 miles and then appears to terminate rather abruptly in a saddle-shaped summit, 762m high, about 8 miles S of the mouth of the Rio Aquan. A sugarloaf peak, of much less elevation, stands W of the summit. A wide valley lies between this peak and Montanas de Trujillo.

**6.15** The Rio Aquan (Rio Aguan) enters the sea by two mouths about 2.5 miles apart and extends about 120 miles inland. The E mouth lies about 16 miles WNW of Cabeza Piedra Grande. Both entrances have shallow depths. The E side of the entrance forms a distinct point, and about 3 miles SE of it and close to the coast is a hill about 24m high. It appears round when seen from the E or W, but from the N its W end appears as a flattened summit and its E end as a sugarloaf hill, separated by a chasm.

The settlement of Santa Rosa de Aquan stands on the E bank of the river, about 1 mile within the E entrance.

Vessels bound for the Rio Aquan should call at Trujillo for clearance in entering and departing.

**Anchorage.**—Anchorage can be taken, in a depth of about 8m, about 1 mile off the mouth of the river. The anchorage should be approached from the NE and continuous soundings should be taken.

Between the Rio Aquan and Punta Caxinas (Punta Castilla), about 16 miles WNW, the coast is low and has no prominent features.

## Islas de la Bahia (Bay Islands)

**6.16** Islas de La Bahia consist of Isla Guanaja, Isla Roatan, Isla Utila, and three small islands. They front the coast for a distance of 75 miles in a WSW direction from a position about 30 miles NNE of Punta Castilla. The group belongs to Honduras.

**Winds—Weather.**—The prevailing winds on the sheltered S side of the islands are from the SE and at times attain a maximum velocity of 45 knots. During the winter months, the winds may come from any direction.

**Tides—Currents.**—The currents in and around the islands are extremely uncertain, particularly during the summer. The Equatorial Current N of the islands sets W, but when the northers have ceased, its surface influence is felt on the islands. The countercurrent generally sets in the opposite direction S of the islands.

The currents in the area may be greatly altered or even re-

versed by winds and tides. The range of the tropic tide at Isla Roatan is greater than anywhere else in the area. The current with a rising tide sets W and N, and with a falling tide sets S and E. A counterclockwise eddy is observed N of Isla Utila.

**6.17 Isla de Guanaja** (Bonacca Island) (16°28'N., 85°54'W.), the E island of the group, is about 8.3 miles long and 2.5 miles wide at its widest part. The island is composed of rugged densely-wooded hills that rise to a height of 365m near its center. The NE extremity consists of a bold peninsula which terminates in East Cliff, 31m high and of an ochre color. Ochre Bluff, at the SW end of the island, is of the same height and color. Several anchorages are available within the coastal reefs, especially on the SE side of the island.

The island stands on a very steep-to bank of coral and sand, as defined by the 200m curve, which extends about 5 miles NE from East Cliff and from 0.8 to 2.8 miles from its other sides. The depths on the bank are irregular and numerous reefs, shoals, and small cays fringe the island, especially on its SE side.

Between East Cliff and a position about 4.3 miles SSW, a chain of small low wooded cays lies on the outer edge of a fringing reef. These cays lie from about 0.5 to 1 mile offshore; the intervening area is interspersed with foul ground and shoals. Various openings between some of the reefs lead into good anchorages, but their use is not recommended to those without local knowledge.

Swift Ridge and **Lark Ridge** (16°25'N., 85°53'W.), about 1 mile long with a depth of 2.7m, lie about 4 miles ENE of Ochre Bluff. They usually break in heavy weather and at other times are easily seen from aloft.

Southwest Cay (Cayo Suroeste), small and tree-covered, lies on a rocky reef about 3.3 miles E of Ochre Bluff. A rocky reef, with general depths of 5.5 to 7.3m, extends about 0.3 mile E from its E side. A 5.5m patch lies 1 mile SW of the SW extremity of the cay.

**Pond Cay** (16°26'N., 85°54'W.), a small cay marked by a light, stands 1.5 miles N of Southwest Cay. Sheen Cays, two islands joined by a bridge, with a settlement on them, stand between Pond Cay and Isla de Guanaja.

Carib Sand Bore, a reef separated from Pond Cay by a narrow deep passage, extends about 1.8 miles SW. The passage has depths of 18 to 31m and is clear of known dangers.

Good anchorage can be taken, in depths of 18 to 20m, about 0.5 mile W of Pond Cay. Other good anchorages exist in the area between Pond and Sheen Cays, in depths of 7 to 16.5m. This entire area has a sand and coral bottom.

Anchorage can be taken about 0.5 mile W of Carib Sand Bore, in a depth of 11m, with the N extremity of Southwest Cay bearing 116°. Smaller vessels can anchor, in 5.5 to 7.3m, on the same bearing, about 0.8 mile W of Southwest Cay. The reef that extends SW from Carib Sand Bore should be given a wide berth when approaching these anchorages.

The area between Southwest Cay and Ochre Bluff provides sheltered anchorages from northers, but care must be taken to avoid the many shoals.

Southwest Cay should be approached from the S and a course laid between the cay and Swift Ridge, putting Pond Cay on the port bow. The reef that extends SW from Pond Cay and the N side of Carib Sand Bore are both steep-to; the water is

deep and clear alongside. The reefs are clearly seen.

**6.18 Guanaja** (16°26'N., 85°54'W.), a small settlement, stands on Sheen Cays, 0.3 mile off the SE side of the island. Some of the buildings stand on piles around the cays. In 1953, the controlling depth in the approach channels and entrance was 9.1m. In 1948, a vessel with a draft of 6.7m entered and anchored within 0.3 mile of the piers. Three small piers off the settlement have depths of 3 to 5.5m alongside.

The usual anchorage lies about 0.3 mile W of the settlement. Vessels are met by fishermen about 0.5 mile E of Pond Cay, who direct them to the loading places. The settlement can be contacted by radiotelephone. Recommended courses to the anchorages are shown on the chart.

**6.19 Isla de Roatan** (16°25'N., 86°23'W.), the largest island of the group, stands about 15 miles W of Isla Guanaja and is about 28 miles long and 2 miles wide. Isla Morat and Isla Barbareta stand close off its E end.

The island is densely-wooded and hilly, with general heights of 91 to 152m. A 224m peak rises about 7 miles from the E end of the island while a 244m peak rises about 6 miles from the W end of the island.

Punta Oeste is the SW extremity of the island. A light is shown from the point. A conspicuous white church, with a red roof and a square bell tower, stands about 2 miles ENE of Punta Oeste. Coxen Road and Puerto Real, both on the S shore, provide the best anchorage for larger vessels. Other bays and coves indent the S side of the island, but are available only to small craft. The population of the island is concentrated along the S shore.

The W and SW parts of the island are steep-to, but elsewhere the island is fringed by a steep-to reef that extends up to 1 mile offshore. Isla Barbareta, off the E end of the island, is fronted by a reef that lies up to about 2 miles off its E and S sides.

The only other known off-lying dangers lie off the coast in the vicinity of Coxen Road.

**6.20 Puerto Real** (16°24'N., 86°17'W.), a small harbor on the S side of the island, provides anchorage, in depths of 9 to 18m. Shelter is provided from the S by George Reef, George Cay, and Long Reef. George Reef extends about 1 mile W from the E side of the harbor and George Cay, low and wooded, with the ruins of a fort at its W end, stands about 230m from the W end of the reef. Long Reef, separated from George Reef by a channel about 0.1 mile wide, is a nearly dry ledge, 0.8 mile long, that protects the W side of the harbor.

In 1938, the 0.1 mile wide channel between the reefs had a reported depths of 5.5 to 8.2m. The eye is sufficient guide, as the reefs are steep-to and easily seen. A good landmark is the 224m peak that stands about 0.8 mile W of the harbor.

The best anchorage is in a depth of 11m, sand, about 0.4 mile NW of George Cay.

Oak Ridge Harbor is located about 4 miles W of Puerto Real and is entered through a narrow channel, with a least depth of 6.1m, which leads N to the anchorage off the town. Coastal vessels, with drafts up to 4.9m, can anchor here, in depths of 6 to 7.6m.

A conspicuous, stranded wreck lies close W of the entrance of the channel and is a good mark in the approach. A pier ex-

tends from the shore of the harbor.

French Harbor stands about 10 miles W of Puerto Real. The town of French Harbor is almost surrounded by water, as an extensive lagoon backs it. There are anchorages, in depths of 22 to 36m, but local knowledge or the services of a local pilot is necessary.

**6.21 Coxen Hole** (Coxen Road) (Roatan) (16°19'N., 86°33'W.) (World Port Index No. 9675), the principal harbor on the island, occupies the E part of a bight on the S shore of the island, about 3.8 miles ENE of Punta Oeste. It is the only port of entry for the Islas de La Bahia and is also the seat of government. Vessels must enter here first before proceeding to the other islands in the group.



Coxen Hole (background)



Coxen Hole (small port area)

A 'T' shaped pier is situated on the S side of the harbor. The pier has a length of 160m and with use of the dolphins can accommodate a vessel loa of 305m with an alongside depth of 10.4m.

Its W side is bordered by dark, 6.1m high cliffs; its E and S sides are bordered by the reef upon which Coxen Cay (Big Cay) stands. Carib Point, in about the middle of the bight, has high coconut trees on it. Hendricks Hill, a conspicuous 91m hill, stands about 0.5 mile N of the point. A 274m peak rises about 0.8 mile NE of Hendricks Hill.

Banco Becerro (Seal Bank), nearly awash near its center and





Wreck near Coxen Hole

with depths of 2.7 to 5.5m elsewhere, lies about 0.3 mile SW of Coxen Cay (Big Cay). A 275m wide channel, with depths of 9.1 to 18m, leads between Banco Becerro and the reef SW of Coxen Cay (Big Cay). The use of this channel is not recommended because of the dangers which lie S and SE of the entrance.

An isolated shoal, with a depth of 9.1m, was reported (1962) to lie about 11 miles SSE of the light at the SW end of the island. A 15m shoal was reported (1985) to lie 4.5 miles SW of the light.

**Banco Smith** (16°17'N., 86°35'W.), with a least depth of 5.5m, lies about 1 mile SSW of Coxen Cay (Big Cay); Banco Cordelia, which dries, lies about the same distance ESE. A bank, about 1 mile in extent, with depths of 5.5 to 22m, lies 1.5 miles SE of Coxen Cay (Big Cay).

Daring Shoal, a detached 4.6m patch, lies 2.5 miles E of Coxen Cay (Big Cay) and is reported joined to Banco Cordelia by a narrow ridge with depths of less than 18m.

**Pilotage.**—Pilots are available and board about 2 miles ENE of Punta Oeste Light. The signal for a pilot is one long blast on the whistle or siren in addition to the prescribed flag hoist.

**Anchorage.**—The best anchorage lies off the NW side of Coxen Cay (Big Cay), in a depth of 12m, with the SW extremity of the cay bearing 156°. Other good anchorages are available in the vicinity, in depths of 26 to 29m, but they are generally more exposed. The bottom is sand interspersed with coral beds.

**6.22 Isla de Utila** (16°06'N., 86°56'W.), the W island of the group, stands about 18 miles SW of Isla de Roatan. The island is about 7.5 miles long and varies from 1.3 to 2.8 miles wide. It is generally low, swampy, and thickly wooded, and is marked by a range of 18 to 21m high hills near its E end. Pumpkin Hill, 88m high and conical, stands near the NE extremity of the island. A disused black framework light structure stands near the W extremity of the island.

The island, with the exception of its SW side, is relatively steep-to and has general depths of 29 to 37m lying about 0.1 mile offshore; in many places deep water extends to the shore.

The N side of the island is indented by several shallow bays.

An area of foul ground extends about 4.8 miles SW from the SW side of the island and is about 3 to 4 miles wide. Several good anchorages lie within this area, but their use is restricted to those with local knowledge.

A 12.8m shoal was reported (1973) to lie 10 miles NW of the W end of Isla de Utila and an 11m shoal was reported to lie about 7 miles SSW of the same point.

An 11m patch lies about 6.5 miles S of the SE extremity of the island, with several soundings of 12.8 to 14.6m being found in between.

**6.23 Puerto Este** (East Harbor) (16°06'N., 86°54'W.) (World Port Index No. 9665), the principal and only deep-water harbor on the island, stands about 1 mile W of the 6m black and red cliffs that form the SE extremity of Isla de Utila. The harbor is about 0.8 mile in extent and provides anchorage, in depths of 7 to 11m, clay over coral. There is a small settlement at Puerto Este. Cargo is lightered in large canoes.

**Depths—Limitations.**—The entrance leading into the harbor is narrowed to a width of 275m by reefs extending from the E and W sides of the harbor. Depths in the entrance channel range from 9.1 to 11m, shoaling to a depth of 7.3m about 0.2 mile from the shore within the harbor.

**Pilotage.**—Pilotage is compulsory; reliable pilots are available and should be used. Pilots board vessels about 0.5 to 1 mile seaward of the entrance. The signal for a pilot is one long blast on the whistle or siren.

**Anchorage.**—Sheltered anchorage is available for two or three moderate-size vessels.

**Directions.**—The entrance must be navigated by eye to avoid the reefs on either side of the entrance and two small coral heads that lie within the harbor, about 0.3 mile from the E shore. A church steeple, in line bearing 020° with a prominent tree, is the leading mark used by local pilots.

It was reported that to enter the harbor a vessel should steer 040°, passing about 0.1 mile off a stake on the coral reef on the E side of the entrance. Careful use of the lead is important.

## Punta Caxinas to La Ceiba

**6.24 Punta Caxinas** (16°02'N., 86°01'W.), a low rounded point with a narrow beach backed by swamps and woods, stands at the W extremity of Cabo de Honduras and is the N entrance point to Bahia de Trujillo.

Bahia de Trujillo is 7 miles wide between Punta Caxinas and the coast to the S, and recedes 5 miles to the E.

The coast from the S entrance point of Bahia Trujillo extends W for 115 miles to Punta Caballos. The shore is generally low, wooded, and bordered by sandy beaches. Mountain ranges, that reach the shore in some localities and recede up to 10 miles in others back the coast from Bahia Trujillo to Tela, about 85 miles W. South of Tela, the mountain ranges curve inland and extend to the SW. An extensive low densely-wooded plain lies between the base of the ranges and Montanas de Omoa, about 30 miles to the W.

The above ranges rise to high prominent peaks S and SW of Bahia de Trujillo and S and SE of Punta Congrejal. These peaks are good landmarks from the offing, particularly Cerro Congrejal, a 2,454m peak that stands 10 miles SW of Punta

Congrejal.

Few navigational aids exist along this stretch of coast.

**6.25 Bahia de Trujillo** (15°58'N., 86°00'W.) is about 7 miles wide at its entrance and recedes 5 miles E to its head. Puerto Castilla stands on the N side of the bay and Trujillo on the SE side.

Within Bahia de Trujillo, there is very little current during calms or E winds; with W winds the current sets E and counterclockwise around the bay at rates ranging up to 2 knots.

During strong NW to NE winds, a heavy swell is experienced in the bay.

A shallow channel at the E end of the bay leads into a spacious lagoon. Depths in the central part of the bay range from 11.9 to 56m. An 18m depth was reported (1984) to lie 1 mile SSW of the W extremity of Cabo de Honduras and a 10m depth was reported to lie 2.3 miles WNW of the same point.

The 20m curve lies just off the pier at Puerto Castilla and extends E and W about 0.3 mile offshore. Callo Blanco, a dangerous reef, lies about 5 miles S of Punta Caxinas.

The N and E shores of Bahia de Trujillo are low, swampy, and wooded; they offer no prominent landmarks. The S shore is backed by a high mountain chain which extends almost to the shore at Trujillo. Pico Colentura, a 975m peak, stands 3 miles S of the town and the Vigia, or lookout hill, 762m high, stands at the NE end of the mountain chain. These mountains are sometimes referred to as Montanas de Trujillo.

The tank situated in Puerto Castilla is higher than the surrounding vegetation and can be seen about 12 miles from the N.

The twin spires of the church in Trujillo are conspicuous.

Pilotage is compulsory when entering Bahia Trujillo. Vessels may enter and depart only during daylight hours. Vessels are advised that there are only a few navigational aids available, and those few are unreliable.

Vessels approaching Bahia de Trujillo should steer to pass 1 to 1.5 miles off Punta Caxinas.

**6.26 Puerto Castilla** (16°00'N., 85°58'W.) (World Port Index No. 9690) stands about 2 miles SE of Cabo de Honduras Light on the N side of Bahia de Trujillo.

**Puerto Castilla Home Pagee**

[www.enp.hn/web/puertodecastilla.html](http://www.enp.hn/web/puertodecastilla.html)

**Depths—Limitations.**—A concrete pier, 225m long and 38m wide, can accommodate a vessel with a maximum draft of 10.9m.

**Pilotage.**—Pilotage is compulsory for vessels over 300 grt. Vessels should advise ETA directly, and to agents 72 hours, 48 hours, 24 hours, 12 hours, and 6 hours prior to arrival. Pilots must be ordered 24 hours in advance.

The port can be contacted, as follows:

1. VHF: VHF channels 6 and 16
2. Telephone: 1-504-242-98013
3. Facsimile: 1-504-242-98013

**Anchorage.**—Anchorage, sheltered from all except W winds, may be taken about 0.2 mile S of the pier head at Puerto Castilla, in a depth of 30m, hard sand and mud.

**6.27 Trujillo** (15°55'N., 85°57'W.) (World Port Index No. 9680), a port of entry, stands on a slight eminence, with a small fort in front, on the S side of Bahia de Trujillo. Pilotage is recommended but not compulsory. The town pier is 61m long and has a least depth of 4.9m alongside its S face. The coast between Bahia Trujillo and Punta Catchabutan, about 27 miles W, is indented by Ensenada Quemada, a bight that recedes about 5 miles S from the general line of the coast. Shoals extend from both entrance points and the depths off the bight are irregular and necessitate caution. The bight itself is apparently clear of dangers.

High rugged wooded mountains back the coast from Bahia Trujillo to Balfate, a small town on the S shore of Ensenada Quemada. These mountains nearly reach the shore just S of Balfate. In the vicinity of the town the shore is rocky, uneven, and heavily wooded.

Between Punta Catchabutan and Punta Congrejal, about 17 miles to the W, the coast is low, wooded, and backed by a high mountain chain. This chain rises to Cerro Nana Cruz, a 1,859m peak, located 9 miles SE of Punta Congrejal.

**6.28 Punta Congrejal** (15°47'N., 86°51'W.), a low sandy point, is marked by the trunks of trees. Discolored water from the Rio Congrejal extends some distance seaward from the point. Depths of less than 11m extend up to 1.5 miles off this point. A tall tree, prominent from the E, stands about 0.8 mile W of the point.

The mountain chain that backs this part of the coast rises to Cerro Nana Cruz, SE of Punta Congrejal, and to Cerro Congrejal (Bonito Peak), about 10 miles SW of the point. This 2,454m peak, when seen from the NE, appears above the neighboring mountains as a well-defined sharp cone, but when seen from the NW, a small flat shoulder projects E just below the summit.

### La Ceiba (15°47'N., 86°48'W.)

World Port Index No. 9670

**6.29 La Ceiba**, an open roadstead, is situated about 1 mile SW of Punta Congrejal. It is one of the principal ports of Honduras and is a port of entry.

**Winds—Weather.**—The prevailing winds during the day are NE while the prevailing winds at night are SW. Normally the weather is calm with gentle breezes, except during the season of the northers, when winds of gale force occur.

**Tides—Currents.**—The current in the area has been reported to be W, attaining a velocity of 2 knots at times. During the northers the current sets S.

**Depths—Limitations.**—The 10m curve lies about 0.3 to 0.5 mile offshore, decreasing gradually to the shore. Vessels with a maximum draft of 8m can enter the harbor.

La Ceiba pier, W side length 427m with depths alongside 5.8 to 10.0m at the outer end. The berth on the E side has lesser depths.

A smaller port area, known as the New Cabotage Port, has been reported (2009) to lie about 2.5 miles E of La Ceiba. This facility is approached between two breakwaters, which create an entrance with a width of about 100m. The W breakwater is about 500m long, while the E breakwater is about 300m long. The quay is 300m in length and handles vessels with a maxi-



**La Ceiba—New Cabotage Port**

mum draft of 4m.

**Pilotage.**—Pilotage is compulsory. Pilots board about 1 mile NW of the pier. Vessels should send ETA no more than 24 hours and no less than 8 hours prior to arrival. Pilot should be requested 2 hours prior to arrival. Docking and undocking can be done at anytime.

**Anchorage.**—Vessels may anchor as convenient, but anchorage is prohibited E of the pier. In 1985, a vessel with a draft of 10.7m anchored 1 mile NW of the pier, in a depth of 15m, sand and mud, good holding ground. On the approach of a norther, vessels are advised to proceed to sea.

**Caution.**—A vessel with a maximum draft of 5.5m was sighted laying aground about 0.3 mile NE of the pier head; the depth in this position is 10.4m.

Discolored water from the mouth of the Rio Congrejal extends for some distance off the coast.

### Off-lying Banks and Islands

**6.30** The 200m curve generally follows the trend of the coast and lies up to 24 miles offshore; N of Punta Sal, the curve turns abruptly and extends S to the coast. Soundings are irregular in the area within the curve between Tela and Punta Sal. West of Punta Sal, the 200m curve lies 1 mile off the Rio Ulua and about 4 miles N of Punta Caballos.

A 9.1m patch lies 7 miles WNW of Punta Caxinas; a depth of 14.6m lies 4.5 miles NW of the same point. A depth of 17.4m lies 7.5 miles N of Punta Caxinas.

**Cayos Cochinos** (15°58'N., 86°34'W.) lie about 9 miles N of Punta Catchabutan and 27 miles W of Punta Caxinas. The E island of the group is densely wooded and rises to a height of 131m. The N side of the island is steep-to, but a coral spit, with depths of 7.3 to 11m, extends 1.3 miles from the E side. A group of cays and rocks lies a short distance off the S side. A light stands on the E side of the island of Cochino Grande.

Cochino Pequeno, another island lying 1 mile farther SW, rises to a height of 152m; it is wooded. A steep-to coral ledge, with numerous cays and sand banks, extends about 3 miles SW from the islands. The channel between the islands has depths of 26 to 29m. Depths of 7.6 to 11.3m lie off the NW side of

these two islands.

**Banco Providencia** (15°55'N., 86°38'W.), a dangerous bank, lies 9 miles NW of Punta Catchabutan.

**Caution.**—Dangerous uncharted shoals are likely to be encountered anywhere within the 200m contour in this area.

**6.31 Banco Salmedina** (15°55'N., 87°05'W.) lies 25 miles W of Banco Providencia and 10 miles offshore; it is a dangerous steep-to coral patch. There is a least depth of 0.6m near its E end, which breaks when there is any swell. A detached 7.3m patch lies about 1 mile SSE of the bank and a 4.6m patch lies 6 miles NE of it. The bank should be given a berth of at least 2 miles.

**Winds—Weather.**—The winds along the coast of Honduras are E throughout most of the year, with a pronounced diurnal variation. Calms and light offshore winds are frequent during the late night and early morning. Strong winds seldom blow in the early morning, except during the months of November and December. During these months, there are several days with N winds that attain gale force.

**Tides—Currents.**—The usual set of the current off this coast is E within the 200m curve. This current is uncertain, however, due to the influence of the tides and winds.

### La Ceiba to Punta Caballos

**6.32** Between Punta Congrejal and Punta Izapo, about 34 miles to the W, the flat coastal plain gradually widens as the mountains become more sloping and recede inland. There are swamps and marshes a short distance inland and numerous streams discharge into the sea. The shore is covered with trees and thick vegetation that almost reaches the water's edge.

**Punta Izapo** (Obispo) (15°51'N., 87°23'W.), a bluff, rocky, and tree-covered headland, is the termination of a conspicuous, conical, and grassy hill. The Clerks, a group of rocks 6m high, lie close off the point; depths of 37m lie within 0.5 mile or less of the rocks.

The entire area from the NE through N to NW of Punta Izapo have depths as little as 6.4m; these depths may best be seen on the chart.

Punta El Triunfo, a bold rocky projection, stands about 4 miles SW of Punta Izapo.

**Caution.**—It has been reported (2009) that a wreck lies about 10.5 miles N of Punta Izapo in a depth of 36m.

**Bahia de Tela** (15°47'N., 87°27'W.), entered between Punta El Triunfo and Punta Sal, about 12.5 miles NW, is bordered by a low sandy coast, but is backed by a high mountain ridge, about 8 miles S of Punta Izapo. A mountain range, 610 to 914m high, backs the coast in the vicinity of Tela, but just W of the town it veers inland and extends S.

Laguana de los Micos, a large, shallow, body of water, backs the bay and is entered about 6 miles NW of Tela.

**6.33 Tela** (15°47'N., 87°27'W.) (World Port Index No. 9660), an open roadstead, is situated in the SE part of Bahia de Tela, close within the E entrance point. This is the second ranking port in Honduras.

**Winds—Weather.**—The prevailing winds are E and NE, but several strong northers may be experienced in the winter

months. During a N wind of any significance, it is impossible to remain at the pier.

The average tidal range is about 0.3m, but the water level is also raised or lowered by the wind. The current off the pier has been reported to set W in the morning and E in the afternoon.

**Depths—Limitations.**—A jetty, about 610m long, extends N from shore abreast the town.

DIPPASA Atlantic Terminal (15°47.4'N., 87°27.6'W.) consists of a CBM (six mooring buoys) laid approximately 0.2 mile N of the ruined pier. A submarine pipeline, marked by a white pillar buoy, is connected to the shore; the ends of the flexible discharge hoses are marked by small red buoys. Vessels connect the hoses to the starboard manifold. Vessels up to 50,000 dwt with a maximum length of 200m can be handled.

**Aspect.**—A few houses and a prominent bridge standing E of the pier are the first objects to be sighted on approaching the town.

**Pilotage.**—Pilotage is compulsory for vessels over 300 gross tons and is provided by Puerto Cortez. The pilot embark about 1.7 miles NNW of the pier head. The approach to the pilot station should be from the N, passing between the 9.1m and 8m shoal depths charted about 4.3 miles N and 5.3 miles NNW, respectively, of the pier head. An ETA should be sent 96 hours, 72 hours, 48 hours, and 24 hours in advance. The pilot departs from Puerto Cortez.

**Contact Information.**—The port can be contacted, as follows:

1. VHF: VHF channel 16
2. Telephone: 1-504-244-82448
3. Facsimile: 1-504-244-82501

**Anchorage.**—Anchorage can be taken N or NW of the pier head, in depths of 14 to 18m. It is recommended that the main engines remain on standby during the months from December to May at this anchorage, as the vessel may need to put to sea quickly due to an occasional and sudden build up of swell.

**6.34 Punta Sal** (15°55'N., 87°36'W.), a bold rocky promontory, projects about 2 miles NE from the coast and rises to wooded, irregular hills. It appears as an island when viewed against the low land to the S. A light is shown from the N end of Punta Sal. Four islets, similar to The Clerks, but much higher, lie about 0.5 mile off the E extremity of the point.

The coast between Punta Sal and Punta Caballos, about 22 miles WSW, is low, sandy, and densely-wooded. Montanas de Omoa back the latter part of this coast.

Puerto Escondido, a cove, lies 2 miles SW of Punta Sal, and the entrance to Laguna Tinto lies 1 mile farther SW; they are available only to small coasters.

Punta Ulua, a low-defined point, stands on the E side of the entrance to the Rio Ulua, about 4 miles W of the entrance to Laguna Tinto. This large river is navigable by small river steamers for about 139 miles. The muddy discharge from the river discolors the sea for some distance offshore.

The Rio Chamelecon entrance, about 6 miles WSW of the Rio Ulua, may be identified by an isolated 194m conical hill nearby.

Punta Caballos stands about 9 miles WSW of the Rio Chamelecon. The low, wooded intervening coast is backed by a mountain range. Shoals border about 5 miles of this section of coast and extend up to 2.3 miles offshore in places.



**Punta Sal**

The 20m curve lies about 0.5 mile off Punta Sal, while it runs close under Punta Ulua. About 8 miles SSW of Punta Ulua, a dangerous rock lies close within the 10m contour, about 1 mile offshore.

A dangerous below-water rock lies 1.5 miles NW of Cerro Cardona and a 12.8m shoal was reported (1960) 1.5 miles farther NW. A shoal, with a depth of 9.1m, lies about 3.3 miles WNW of Cerro Cardona. These dangers are best seen on the chart.

Shoals, with depths of 9.1m and 10.1m, have been reported 2.5 miles NNE and 3 miles N, respectively, of Punta Caballos.

**Anchorage.**—Anchorage may be taken about 0.5 mile off Laguna Tinto in moderate weather, in a depth of 14m, mud. The bottom is rocky farther out.

### **Punta Caballos to Puerto Cortez**

**6.35 Punta Caballos** (15°50'N., 87°58'W.) is the W extremity of a low, wooded peninsula that forms the N side of the harbor of Puerto Cortez. Numerous detached shoal patches, with depths of 8.2 to 15.5m, have been reported at various times to lie within an area bounded by a line extending 4 miles WSW from Punta Caballos Light, then 4.5 miles N, then 3.8 miles E, and then S to the shore. The positions of these shoals can best be seen on the chart.

The coast from Punta Caballos to Cabo Tres Puntas, 39 miles WNW, forms a bight that indents the coast about 11 miles to the S. Puerto Cortez occupies the E part of this bight while Ensenada de Omoa occupies the S part. The Rio Motagua enters the sea near the W part of Ensenada de Omoa and forms the boundary between Honduras and Guatemala. The E side of the bight is bounded by the base of the Montanas de Omoa, which rise to several prominent peaks. This range extends inland to the SW from the head of the bight and the land to the W becomes low and swampy.



### Puerto Cortes

Bahia de Amatique (Honduras Bay) is entered between Cabo Tres Puntas and Punta Gorda, about 13.5 miles NW. The E side of the bay recedes about 13 miles S to the narrow entrance of Bahia de Santo Tomas, which recedes an additional 2.5 miles to its head. The W side of the bay extends about 23 miles NW, then curves NE for 10 miles to Punta Gorda. The Sarstoon River, which defines the boundary between Guatemala and Belize, lies about 5 miles SSE of the W head of the bay.

The coast of Belize extends about 102 miles NNE between Punta Gorda and Belize City.

This coast is fronted by a barrier reef which lies from 10 to 22 miles offshore, and numerous cays, reefs, and shoals are interspersed in the area between the barrier reef and the coast. The passages between these dangers and the coast are known as the Inner or Main Channel.

Few landmarks are to be found along the coast and on the cays, but lights mark most of the principal points along the coast and some of the cays and off-lying dangers.

The 200m curve lies about 4 miles NW of Punta Caballos and follows the general trend of the coast for about 18 miles to a position 6 miles NNW of the Rio Motagua. From this latter position it extends 13 miles to the shoals S of the S part of the

barrier reef off the coast of Belize. It then extends in a general N direction for 94 miles to a position about 8 miles E of Belize City.

In the approach to Punta Caballos, Cerro Cardona (15°53'N., 87°51'W.), an isolated conical hill 158m high, is located 7.5 miles ENE of the point. Several radio masts situated on the point are good landmarks.

**Caution.**—Care is necessary when navigating in the vicinity of Punta Caballos as the area has not been completely examined.

### Puerto Cortes (15°50'N., 87°57'W.)

World Port Index No. 9650

**6.36** Puerto Cortes, the major importing town of Honduras, is situated on the N side of the Bahia de Cortes, close within the S side of the peninsula terminating at Punta Caballos.

**Winds—Weather.**—The prevailing winds are from the E and NE. West and SW winds raise moderate to heavy surf within the bay. The harbor is sheltered from northers, but storms are infrequent.

Puerto Cortes—Berth Information						
Berth	Length	Draft	Maximum Vessel			Remarks
			Size	LOA	Beam	
No. 1	120m	12.0m	45,000 dwt	185m	35.0m	Petroleum products, chemicals, and LPG.
No. 1A	88m	10.9m	40,000 dwt	185m	—	Molasses and chemicals. Concrete T-head pier.

Puerto Cortes—Berth Information						
Berth	Length	Draft	Maximum Vessel			Remarks
			Size	LOA	Beam	
Gases del Caribe Terminal	—	13.0m	50,000 dwt	230m	36.0m	CBM facility for LPG vessels.
No. 2	—	—	—	—	—	Future dry bulk berth. Pier No. 2 is the old banana wharf. A 2.7m shoal lies close S of the W end of the pier. This pier has been reported (1993) to be in ruins and out of service.
No. 3	195m	11.2m	40,000 dwt	250m	—	Tankers, bulk cargo, and general cargo.
No. 4	348m	10.3m	—	—	—	Bulk, general cargo, and containers at the E end. Ro-ro cargo at the W end.
No. 5	380m	10.5m	—	—	—	Containers, general cargo, and ro-ro.
Cabotage Pier	100m	5.5m	—	—	—	Coasters.

**Tides—Currents.**—The current within the harbors is uncertain and large vessels approaching the piers should do so with caution, as unexpected currents and winds may be experienced. The current is often contrary to the wind. It has been reported a significant E current was experienced 2 miles N of Punta Caballos.

**Depths—Limitations.**—The North Channel access to the terminal is 1,200m long and 400m wide. It has a controlling depth of 11m and is marked by beacons and lighted beacons. For berthing information see the table titled **Puerto Cortes—Berth Information**.



**Puerto Cortes**

The piers are exposed to W and SW winds, which may cause berthing problems.

**Aspect.**—On approaching Puerto Cortes, the radio masts on Punta Caballos; the towers of the refinery, about 0.3 mile E of the light on Punta Caballos; Saddle Hill, 536m high, 5 miles SSE of Punta Caballos; the red roof of the hotel in Puerto Cortes; and the water tank 2.3 miles SE of Punta Caballos are



**Puerto Cortes Light**

good landmarks. Puerto Cortes Light is located on the W coast of the penninsula.

**Pilotage.**—Pilotage is compulsory. An ETA is required 72 hours, 48 hours, and 24 hours prior to arrival.

Vessels will be given clearance from 0600 to 2000. Special arrangements may be made with local authorities to obtain clearance at any other time. Vessels may enter and depart at any time provided prior arrangements have been made. Tugs

are required for vessels of more than 1,000 grt.

Pilots may be contacted on VHF channels 6 and 16. They will embark 2 miles N of Punta Omoa, 1 mile NNW of Punta Caballos or 0.5 mile WSW of the piers.

**Anchorage.**—Good anchorage, sheltered from northers, can be taken, in depths of 11 to 16.5m, mud or sand, about 0.5 mile from shore. Once a vessel enters the bay and no berthing space has been indicated, the vessel should anchor more than 0.5 mile from the closest pier and await the official boarding party for clearance.

**Caution.**—Submarine cables extend seaward for about 2 miles NNW from the N peninsula of Puerto Cortes.

## Puerto Cortes to Puerto Barrios

**6.37** For about 2 miles WSW of Punta Caballos (15°50'N., 87°58'W.), the coast, which is low, sandy, and wooded, is backed by high wooded mountains; it is fronted by a bank, with depths of less than 5m, which extends up to nearly 1 mile offshore.

The Rio Tulian discharges into the bay, about 2.5 miles SSW of Punta Caballos; the Rio Chivana, a small stream discharges into the bay about 1.8 miles farther WSW.

**Punta de Omoa** (15°47'N., 88°03'W.) is a low, but prominent, point about 6.3 miles SW of Punta Caballos. Red cliffs stand on the coast about 3 miles E of the point; the intervening low sandy coast is backed by high, wooded ground and mountains. A disused lighthouse stands on Punta de Omoa.

Omoa, a small sheltered port, stands close S of Punta de Omoa. A small wharf fronts the town.

Ensenada de Omoa is a bight which lies between Punta de Omoa and the mouth of the Rio Montagua, about 10.5 miles WSW. There are depths of 37 to 55m lying about 1 mile offshore, and the bight is clear of any known dangers. A heavy swell rolls in after northers.

The mountain range that backs this section of coast is known as Montanas de Omoa. This range terminates about 9 miles SW of the head of Ensenada de Omoa in Pico de Montagua, a 2,228m peak. The other prominent peaks in this range are usually obscured. The two most useful peaks are Saddle Hill, S of Punta Caballos, and a prominent 997m peak which stands about 3.5 miles S of Omoa and has a sharp cone. When viewed from the NW, this peak has a small shoulder projecting from it, just below the summit.

Berthing and cargo operations are only carried out in daylight hours and in good weather. Pilots board about 1.5 N of the berth. The CBM berth for handling LPG has a least depth of 9m.

**Caution.**—A submarine pipeline extends from the shore to a group of mooring buoys about 0.5 mile N of Punta de Omoa.

**6.38** The **Rio Montagua** (15°44'N., 88°13'W.), a fairly large, shallow river is navigable by river boats up to about 35 miles above its mouth. This river marks the boundary between Honduras and Guatemala.

Between the Rio Montagua and Cabo Tres Puntas, about 27 miles NW, the low, swampy coast is bordered by a dark sandy beach backed by trees.

The Rio San Francisco del Mar discharges about 14 miles NW of the Rio Montagua; a branch of this river leads to Bahia

La Graciosa.

A conspicuous 183m high tableland stands about 8 miles SW of the mouth of this river.

**Cabo Tres Puntas** (Cape Three Points) (15°58'N., 88°37'W.), a prominent well-wooded point, is the NW extremity of a low, wooded peninsula about 11 miles long which borders the NE side of Bahia de Amatique. A conspicuous tower stands on the cape. Steep-to foul ground, which usually breaks, extends about 0.5 mile W from the cape.

A detached 11m patch lies about 2.5 miles ENE of Cabo Tres Puntas; a detached 14.6m shoal patch lies about 3 miles farther in the same direction.

## Bahia de Amatique

**6.39** **Bahia de Amatique** (Honduras Bay) (15°56'N., 88°44'W.) is entered between Cabo Tres Puntas and Punta Gorda, about 13.5 miles NW. It has general depths of 9 to 31m over its central part, shoaling gradually toward the shore. The E side of the bay recedes about 13 miles S to the narrow entrance of Bahia de Santo Tomas de Castilla, which recedes an additional 2.5 miles S to its head. The land on the E side of the bay is generally flat, swampy, and densely wooded. From the entrance to Bahia de Santo Tomas de Castilla, the W side of the bay extends about 23 miles NW and then about 10 miles NE to Punta Gorda. The land on the W side of the bay is higher, densely wooded, and backed by mountain ranges.

From Cabo Tres Puntas the E side of the bay extends about 1.5 miles SSE to Punta Manabique, and then about 5.8 miles SE to Firewood point.

Bahia La Graciosa (Hospital Bight) is a shallow bight that recedes about 4 miles to the SE and is entered between Firewood Point and Punta Manglar. A sand bar, with a depth of 4.3m, extends across the entrance.

**Ox Tongue Shoal** (15°53'N., 88°38'W.), a narrow shoal with depths of 5.5m and less, extends about 7.5 miles WNW from Punta Manglar. A light stands on the W extremity of Ox Tongue Shoal. It has been reported (1984) that due to reef buildup, this light should be kept at least 1.3 miles to the E when entering or leaving port.

Heredia Shoal, with a least depth of 5.5m, lies 3 miles SSE of Ox Tongue Shoal and is marked by a light on the N side.

Shoals, with depths of 8.5m and 12.8m, lie 3.3 miles and 4.8 miles SE, respectively, of Heredia Shoal Light.

Joseph John Shoal, with a depth of 4m, and Key Shoal, with a depth of 4.6m, lie 1 mile SW and 1.8 miles SW, respectively, from Heredia Shoal.

An anchorage area is located about 1.5 miles E of Joseph Shoal and about 4.25 miles W of Punta Manglar.

**Bajo Villedo** (15°45'N., 88°37'W.), marked by a light, has a least charted depth of 4.7m; it lies W of the range lights leading to Puerto Santo Tomas de Castilla.

From Punta Manglar, the low and swampy coast extends about 7.5 miles SSW to the E entrance point of Bahia de Santo Tomas de Castilla.

Good anchorage can be taken, in depths of 9 to 10m, about 2 miles N of Bajo Villedo.

Bahia de Santo Tomas de Castilla is entered between the point mentioned above and Punta Palma, about 1.5 miles WNW. Its densely-wooded shores are bordered by a mud flat,



Ox Tongue Shoal Light



Bajo Villedo Light



Heredia Shoal Light

leaving a navigable basin about 2 miles in extent between the 5m curves. There are general depths of 5.3 to 10.5m in the bay. An isolated 4.1m patch is located in the W side of the bay, about 0.8 mile SSE from Punta Palma. Although the bay is open to the N, it is quite safe as winds from that direction do not affect this part of the coast.

### Puerto Barrios (15°44'N., 88°36'W.)

World Port Index No. 9620

**6.40** Puerto Barrios, the principal port of Guatemala, stands on the E side of Bahía de Santo Tomás de Castilla, close within the entrance. This port handles about 75 per cent of the import trade of Guatemala.



Puerto Barrios (aerial view)

**Winds—Weather.**—Land and sea breezes are the predominating winds at Puerto Barrios. The sea breeze blows from the N quadrant during daylight hours and gradually diminishes by evening. The land breeze blows from the S quadrant from about midnight until sunrise. This regular cycle is altered by northers which occur during the winter months.

**Tides—Currents.**—The current off the pier is reported to be diurnal in nature. During the morning, the current sets NW at a rate of 0.4 knots and occasionally at 2.3 knots. The velocity increases after a strong norther has abated and during periods of heavy rain. In the afternoon, the current reverses and sets SE at a rate of 0.2 to 0.6 knots. The mean rise and fall of the tide is less than 0.3m.

**Depths—Limitations.**—The depth at the channel entrance is 9.7m and is marked by lit buoys.

A pier, 305m long, extends W from the shore in Puerto Barrios. A submerged ruined extension of this jetty, extending 335m further WNW, is marked by lighted buoys. There are





Puerto Barrios



Cabo Tres Light

berths on both sides of the pier. Berth position is indicated by a white flag. The outer berth (N side) has a depth 7.6m. The S side of the pier has 3 berths, length 305m, depth 9.2m.

**Aspect.**—The most conspicuous landmarks to be seen when approaching Puerto Barrios are the pier and the buildings of the town. A conspicuous wreck lies about 1.9 miles S of the pier and is marked by a light.



Pilot buoy in the Bahia de Amitique N of Puerto Barrios

**Pilotage.**—Pilotage is compulsory, for vessels over 100 gross tons. The pilot embarks in the vicinity of Bajo Villedo; if requested, the pilot will embark in the vicinity of Cabo Tres Puntas. Cabo Tres Light is positioned on the N coast of Cabo Tras Punta. Pilotage is provided by Santo Tomas De Castilla.

The pilots can be contacted, as follows:

1. VHF: VHF channels 12 and 16



**Puerto Barrios North Buoy close W of Main Pier**

2. Telephone: 1-502-794-83283  
1-502-792-01500 (Port)

**Regulations.**—Entry is normally permitted only in daylight, but can be arranged at night if sufficient notice is given. Departure is permitted at any time. An ETA should be sent 72 hours and 24 hours in advance.

Port regulations require that a vessel sound three long blasts on the whistle or siren when requesting the port officials to board. When the quarantine flag is hauled down, one short blast must be sounded.

**Signals.**—Two long blasts are required on arrival off the pier. Two long blasts and two short blasts are sounded when the vessel is berthed alongside.

**Anchorage.**—There is unlimited anchorage space available SSW of the pier, clear of the channel, in depths of 5.6 to 7.5m, mud. The holding ground is not good.

Anchorage is prohibited N of the pier due to inbound traffic.

**Directions.**—A dredged channel leads S from a position located 2 miles NNE of Bajo Villedo. Range lights at Santo Tomas de Castilla, bearing 189.5°, indicate this channel. It has been reported (2009) that the channel buoys are out of position.

### **Puerto Santo Tomas de Castilla (15°42'N., 88°37'W.)**

World Port Index No. 9625

**6.41** Puerto Santo Tomas de Castilla, a modern general cargo port, is approached through a dredged channel. It is the main port of entry for Guatemala.

**Winds—Weather.**—Sea breezes predominate between 1100 and sunset, reaching force 4, or occasionally force 6, at about 1500; at other times it is calm, or there are light S winds. This pattern is disturbed by the passage of a depression to the N, when squalls and SW winds may be expected.

**Tides—Currents.**—A weak current, seldom exceeding 0.5 knot, sets SW across the turning basin.

**Depths—Limitations.**—The berthing facility consists of a single wharf, about 918m long, with a depth of 10.1m alongside. Six vessels, each up to 152m in length, can berth alongside, but it is usual for vessels to moor stern to the wharf because of limited maneuvering room and the strong onshore winds. Vessels with drafts up to 11m can safely enter port and moor alongside the pier. Berth No. 6 has a depth of 10.9m, handling vessels up to 228m alongside, depth 9.6m. There are no specialized container berths. Operations are carried out using the ship's cranes or shore mobile cranes.

The approach channel was dredged to a depth of 11m in 1993.



**Puerto Santo Tomas de Castilla**



**Puerto Santo Tomas de Castilla Front Range Light**

It has been reported (1993) that the turning area off the wharf has been extended about 400m to the NE and was dredged to a depth of 11m. The wharf is being extended by a further 500m. There are transit markers on the W side of the port to assist in letting go the anchor when berthing. Anchors are liable to drag.

**Pilotage.**—Pilotage is compulsory for vessels of greater than 500 grt. An ETA is required 72 hours and 24 hours in advance. Pilot boards on request off Cabo Tres Puntas or 1 to 3 miles N of Bajo Villedo.

The pilots can be contacted, as follows:



**Puerto Santo Tomas de Castilla Rear Range Light**



**Wreck in the Shallow Draft Anchorage Area NW of Puerto Santo Tomas de Castilla's Main Channel**



**Light marking a Submerged Obstruction near Puerto Santo Tomas de Castilla (E of Main Channel)**

1. Call sign: Santo Tomas Pilots
2. VHF: VHF channels 12 and 16
3. Telephone: 1-502-794-83283

**Anchorage.**—Anchorage can be taken S of the pier at Puerto Barrios, in the center of the bay, clear of the dredged channel. Vessels with a draft over 7.2m can anchor about 1 mile N of Villedo Light.

**Caution.**—It has been reported (2010) that the forward range for the inbound channel is misaligned and should not be used. An obstruction, marked with a light, with a depth of 3.1m lies about 525m E of the channel and about 0.8 mile N of the range light.



**Buoy 11—Puerto Santo de Castilla**

### **Puerto Santo Tomas de Castilla to Belize City**

**6.42** Between Punta Palma and Punta Herreria (15°49'N., 88°44'W.), about 7 miles NW, the S shore of Bahía de Amatique is backed by high ground that reaches an elevation of 341m about 3 miles S of Livingston Bay. The entire terrain is heavily wooded.

Livingston Bay is entered between Punta Herreria and a point 1.3 miles NW. The Rio Dulce enters the head of the bay. The 2m curve extends across the entrance to the bay and about 0.5 mile farther seaward. The 5m curve lies about 0.5 mile farther seaward.

**6.43 Livingston** (15°50'N., 88°45'W.) is important for the transit of goods by river from the interior. The winds in the area are mostly NE and are most often strong from May to September, with frequent heavy thunder squalls at night. The air is moist in all seasons, with May to October being the unhealthiest time.

A channel 1.8m deep, marked by buoys, leads to the custom house wharf at Livingston.

Vessels usually anchor about 2 miles NE of the town, in depths of 7.3 to 11m, soft sand. Cargo is worked by the means of lighters.

The **Rio Quehueche** (15°51'N., 88°46'W.) discharges into the sea, about 1.3 miles NW of Livingston. It may be identified by a waterfall about 1 mile NW of it. A refinery, with four conspicuous chimneys, is situated 1 mile NW of Livingston.

**Punta Cocoli** (15°53'N., 88°49'W.) is a prominent round bluff located 3.8 miles NW of the entrance to the Rio Quehueche. The Rio Cocoli flows into the sea 0.8 mile SW of this bluff. Vessels can anchor 1 mile NW of the bluff, in a depth of 7m.

From Punta Cocoli, the coast trends 2.5 miles WSW to Punta San Martin and then about 3 miles NNW to the mouth of the Sarstoon River. The coast is low, but about 2 miles inland it is backed by heavily-wooded mountains which rise to a height of 425m, about 2.8 miles SSW of the mouth of the Sarstoon River. The mountains extend about 6 miles W at the same height.

The Sarstoon River forms the boundary between Guatemala and Belize. The river's banks are low, swampy, and covered with mangroves. The entrance is about 0.5 mile wide, and the bar, which generally breaks heavily, has a depth of 1.8m.

The depths off the mouth of the Sarstoon River decrease regularly towards the coast. Depths of less than 11m extend about 4 miles ENE, and depths of less than 5.5m lie about 1 mile ENE from the river's mouth.

**6.44** Between the Sarstoon River and **Orange Point** (16°05'N., 88°49'W.), 12 miles NNE, the coast and the land for a considerable distance inland are flat and densely wooded; some trees reach a height of 61m. About 9 miles NNW of the mouth of the Sarstoon River, a small isolated hill rises to a height of 122m.

From the mouth of the Sarstoon River, the coast trends about 5 miles NNW to the mouth of the Temash River, then about 5 miles NE to Mother Point, a prominent high bluff. Red cliffs are formed between the Temash River and Mother Point. The Moho River enters the sea about 1.5 miles NNE of Mother Point. Orange Point lies about 2.8 miles NE of the mouth of the Moho River; Punta Gorda lies about 1.5 miles farther NNE.

Orange Point is readily identified, as the land in the vicinity is about 9m high, and falls abruptly to the coast. Punta Gorda is marked by a light.

The sea breaks heavily on the bars of the Moho River and the Temash River. Their banks are swampy and fringed with impenetrable mangroves for about 40 or 50 miles, where they become firm and covered with mahogany trees. The current in these rivers attain a rate of 1 knot.

Between the Temash River and Orange Point are a number of off-lying patches, the positions of which may best be seen on the chart.

Several anchorages are available off the mouths of the rivers.

The depths in the channels leading to the anchorages are deep, but intricate, and the water is muddy; they should not be attempted without local knowledge.

A small pier lies close SE of Punta Gorda Light.

**6.45** Between **Punta Gorda** (16°06'N., 88°48'W.) and the Monkey River, about 26 miles NE, the flat densely-wooded coast is indented by numerous shallow bays and bights.



**Punta Gorda, Belize**

Gorda Hill, a conspicuous saddle-shaped hill, 222m high, stands about 2.8 miles NNW of Punta Gorda. A mountain range rises to an elevation of 305m about 6 miles W of Gorda Hill. This range forms part of a chain of mountains that parallels the coast, lying from 10 to 20 miles inland, to within 13 miles SW of Belize City.

The 20m curve lies about 7 miles SE of Punta Gorda and extends in a general NE direction about 17 miles to a position 5 miles SE of Punta Negra. It then extends in an irregular NNE direction to a position 5.5 miles SE of the Monkey River. The area within this curve is foul and is interspersed with numerous cays and shoals.

The **Snake Cays** (16°12'N., 88°32'W.), which lie just outside the 20m curve, S of Punta Negra, are about 8 miles long from SW-NE direction and about 4 miles wide. They consist of four densely-wooded cays and numerous shoal patches with depths of 2 to 9m. East Snake Cay, marked by a light, is the farthest NE; it has trees about 27m high.

**6.46 Pork and Doughboy Point** (16°11'N., 88°44'W.) lies about 6 miles NE of Punta Gorda. The Rio Grande flows into the sea about 2.3 miles SSW of Pork and Doughboy Point.

Port Honduras, an extensive, but foul bay, is formed between Pork and Doughboy Point and Punta Icacos (Ycacos Point), about 9.5 miles NE.

The Deep River (Rio Hondo) flows into the N part of Port Honduras, about 4.5 miles NW of Punta Icacos. There are depths of 0.6m over the bar, and of 3.7 to 5.5m within it. There is anchorage for vessels with local knowledge, in depths of 4.5m, off the W side of the entrance to the Deep River.

**Punta Icacos** (16°15'N., 88°35'W.) is the S extremity of a small cay located close S of a tongue of land which extends 1 mile S; the cay is covered with pine trees.

Wilson Cay is located about 0.8 mile S of Punta Icosos, and about 1.5 miles WNW of the same point are Bedford Cays. There are numerous cays in Port Honduras; their positions may best be seen on the chart.

**Punta Negra** (16°16'N., 88°33'W.) is a conspicuous bluff which stands about 2.8 miles NE of Punta Icosos. Between Punta Negra and the Monkey River, 6.5 miles NNE, the coast is more elevated and is bordered by a sandy beach.



**Punta Negra Bluff**

The Monkey River may be identified by some of the prominent houses in the town, centered principally on the S bank. A light is situated on the S bank of the river at its entrance.

From the Monkey River, the coast extends in a NNE direction about 11 miles to Placentia Point, then continues NNE another 19 miles to Sittee Point.



**Monkey River**

The 20m curve in the vicinity of the Monkey River is ill-defined and follows no definite limit. The 10m curve off this coast is defined and lies 1 mile E of the mouth of the Monkey River, about the same distance off Placentia Point and 0.5 mile off Sittee Point. Vessels that use the Inner Channel or the Main Channel should keep outside its limits, as numerous dangers lie within the curve.

**6.47 Monkey Shoal** (16°23'N., 88°25'W.), a 4m patch with a 5.5m patch close W of it, lies about 4 miles ENE of the light at the Monkey River. A 6.5m patch lies about 0.7 mile SSW of Monkey Shoal; other isolated shoal patches lie in this area. A lighted buoy is moored 1 mile E of Monkey Shoal.

A 5.5m patch and a 5m patch lie 2 miles SSW and 2.3 miles ENE, respectively, from Monkey Shoal; they lie close E of the Main Channel.

Penguin Shoals, with a least charted depth of 3m, lie about 3 miles NNE of Monkey Shoal. There is a 7.5m detached patch about 1.3 miles E of the 3m depth.

Middle Shoal, 0.5 mile NNE of Penguin Shoals, has a least depth of 4m; a lighted buoy is moored 1 mile NE of it.

Potts Shoal, with a least depth of 3.7m, lies about 1.5 miles N of Middle Shoal. A shoal, with a depth of 5.6m, lies 1.3 miles SE of Potts Shoal.

**Bugle Cays** (16°29'N., 88°19'W.) lie about 3 miles SE of Placentia Point; these two cays are located on the E side of the channel. Without local knowledge, these cays will not be distinguished from a distance of more than 4 miles.

Shoals, with depths of 1.8 to 5.5m, extend about 4.8 miles S of Bugle Cays. The Narrows lie between these dangers and Potts Shoal and the other dangers on the W side of the passage. The narrows are about 1.5 miles wide with general depths of 10 to 26m.

From the Monkey River, the coast extends about 11 miles NNE to the entrance to Placentia Lagoon and is low, swampy, and wooded. This shore is fringed by low, wooded cays and intersected by numerous small creeks and streams. Harvest Cay, about 2 miles S of the entrance to Placentia Lagoon, has a conspicuous 24m wooded table hill on it.

**6.48 Big Creek** (16°30'N., 88°25'W.), a narrow river, lies about 2.5 miles W of Placentia Point. It is approached through a buoyed channel, dredged to a depth of 6.7m, entered E of Harvest Cay. A small pier, about 10m long across the face and with a depth of 5.5m alongside, extends from the right bank of the creek. Vessels up to 70m in length can berth port side-to-heading downstream.

**Pilotage.**—Pilotage is compulsory. Pilots will board off English Cay at the entrance to Belize City, provided prior arrangements have been made through the respective agents. A vessel with no appointed agent can sometimes contact the pilot station on 2182 kHz, but Belize Customs Control maintains a constant watch on 2750 kHz. Vessels consigned to Eurocaribe (local) can make contact on 2182 kHz or VHF channel 16. The small boats used are owned by the individual pilots.

Placentia Lagoon, a shallow body of water bordered on its seaward side by a narrow ridge of low land, parallels the coast for about 10 miles. Placentia Point is the S extremity of this ridge. Placentia Cay stands close E of this point.

**Anchorage.**—Anchorage may be taken, close inside the 10m curve, about 0.3 mile S of Placentia Cay.

**Caution.**—The buoys marking the channel may be unlit.

**6.49 From Placentia Point** (18°31'N., 88°22'W.), the coast trends 8.8 miles NNE to Jonathan Point. A series of small bays are formed on this coast by Rum Point, False Point, and Rocky Point, which lie 1.8, 4.3, and 5.3 miles N, respectively, of Placentia Point.

From Jonathan Point, the coast trends about 4 miles N to the mouth of South Stann Creek, then about 3 miles N to the entrance to Sapodilla Lagoon. The 10m curve lies up to 1.5 miles off this part of the coast.

The coast between Placentia Point and the mouth of South Stann Creek is backed by an extensive plain of ridges from 15 to 30m high, bound about 10 miles inland by mountains which reach a height of 1,122m, about 18 miles W of Sapodilla Lagoon. Two peaks, 620m and 512m high, rise about 11.3 miles NW and 9.5 miles WSW, respectively, of the entrance to Sapodilla Lagoon.

**6.50 False Cay** (16°36'N., 88°20'W.) lies about 0.8 mile offshore and about 5 miles NNE of Placentia Point. The cay is low, narrow, and covered with bushes and palms. Foul ground extends about 0.3 mile from it NE through E to its SW side. The W and NW side is steep-to, with depths up to 10m between it and the shore. Sheltered anchorage may be found off the W side of False Cay in depths of 10m.

A pier extends about 150m from shore at the village of Riversdale, about 2.8 miles N of Jonathan Point.

South Stann Creek flows into the sea across a shallow bar about 2 miles NNE of Riversdale.

Anchorage may be taken about 0.5 mile NE of its mouth, in a depth of 7m.

**Sittee Point** (16°48'N., 88°15'W.), marked by a light, is a defined wooded point extending about 0.8 mile from the coast; it forms the S entrance point to the Sittee River.

The **Sittee River** (16°48'N., 88°15'W.) has a depth of 0.9m over the bar at its entrance; dead tree stumps rise from the bottom. Depths of less than 5.5m extend about 0.5 mile E from the river.

There are some ledges located 3.8 miles SE and 4 miles NE of the light on Sittee Point; there are least depths of 4m and 4.5m, respectively, on these ledges. The ledges restrict the fairway of the Inner Channel to 3 miles.

False Sittee Point, a narrow projection of land, stands 2 miles NNW of Sittee Point. Shoal ground extends about 0.8 mile E and NE from the point.

Commerce Bight, entered between False Sittee Point and a point about 6.5 miles NNE, recedes about 3 miles W. The depths within the bight decrease gradually from 11m in the entrance to 5.5m about 0.3 to 0.5 mile offshore.

A conspicuous white building stands close to the coast 2 miles NNW of False Sittee Point.

A pier, with depths of 1.5m alongside the W and S sides, lies 0.5 mile E of the mouth of Yemeri Creek, about 5.3 miles NNE of False Sittee Point. A road connects the pier with Stann Creek Town, about 2.3 miles NE. A light stands on the pier.

**Caution.**—Less water than charted has been reported (1994) to lie within Commerce Bight.

**6.51 Stann Creek Town** (16°58'N., 88°13'W.) stands close N of Commerce Bight, on the N and S sides of North Stann Creek. The village, which fronts the coast for about 1 mile, is the seat of government for the district of Stann Creek. A resident officer resides here.

A jetty, about 122m long, available only to boats, stands about 0.3 mile NNW of the mouth of the creek. There are many prominent buildings between the jetty and the creek. A private



**Stann Creek Town**

jetty, about 183m long, is situated 0.5 mile S of the mouth of the creek.

In 1972, it was reported that a church with a white tower, and a conspicuous square tank on a metal framework tower, stood in the town. Two conspicuous radio mast stands close W of the tank.

Anchorage can be taken, in a depth of 7.3m, less than 0.5 mile off the entrance to North Stann Creek.

From North Stann Creek, the coast trends 6.3 miles NNW to Colson Point (17°04'N., 88°15'W.), which is marked by a light. The 10m curve lies about 2.3 miles off this point. A rock, with a depth of 2m, lies 0.3 mile NNW of the point.

From Colson Point, the coast trends about 1.3 miles W, then turns NNW. The Mullins River flows into the sea 2.8 miles NW of Colson Point. A town, by the same name, stands on the N side of the mouth of the Mullins River. The bar of this river shifts frequently and is dangerous.

**6.52 The Manatee River** (17°13'N., 88°18'W.) enters the sea about 7.8 miles N of the Mullins River; it leads to a shallow lagoon. The bar of this river shifts frequently and is dangerous. A light is occasionally exhibited from a post on the S side of the river mouth.

Dolphin Head, a 122m high hill, rises about 5 miles NW of Manatee River Light. The Paps, 107m high, and Saddle Hill, about 91m high, are hummocks located about 2 miles and 5.3 miles NNW, respectively, of Dolphin Head. These heights are the N terminus of the mountain range that backs the coast of



**Manatee River entrance**

Belize. The coast to the N and the terrain well into the interior is low and swampy in places. The 10m curve lies 3.8 miles off the mouth of the Manatee River. There are several isolated patches between the 10m curve and the W edge of the barrier reef; their positions may best be seen on the chart.

**Mutine Shoal** (17°15'N., 88°09'W.), with a least depth of 6m, lies 9 miles E of the Manatee River; another shoal, with a least depth of 6m, lies 7.5 miles ENE.

Belize City is situated on the S branch of the Belize River, about 17 miles NNE of the Manatee River. The Rio Sibun flows into the sea about 12 miles NNE of the Manatee River. The 10m curve is irregular off this section of the coast. Its limits may best be seen on the chart.

**6.53** The barrier reef which fronts the coast of Belize lies with its seaward or E side, from 10 to 22 miles off the coast. It extends from the Sapodilla Cays, which lie about 31 miles E of Punta Gorda, in a general N direction for about 118 miles to Ambergris Cay. Abreast of Belize City, the barrier reef lies about 8 miles offshore. There are general depths of 1.8 to 5.5m on the reef, but numerous small cays, rocks, and coral banks are interspersed along its entire length. The seaward side is extremely steep-to, with depths of over 200m close off the outer edge. A heavy sea usually breaks along the entire seaward extremity. In the area off the W side of the reef between Sapodilla Cays and Blue Ground Range, about 44 miles NNE, foul ground and numerous cays and shoals extend W to the fairway of Inner Channel or Main Channel. In the vicinity of Blue Ground Range, the W side of the barrier reef becomes regular and fairly steep-to as it extends N to the dangers on the S side of Belize City.

Navigation through the various intricate openings in the barrier reef should not be attempted without local knowledge or the assistance of a pilot. The following description of the cays and dangers which comprise the barrier reef is given with the view of assisting the mariner in the use of these various openings in the event of necessity.

Many of the cays have been planted with coconut palms and some have houses on them. Hurricanes periodically devastate the area or some part of it, and the descriptions of the cays which follow may require update. Though the vegetation normally recovers quickly, the shape of individual cays may be

permanently altered and some may disappear completely.

**6.54 Sapodilla Cays** (16°07'N., 88°16'W.) are a group of small cays located about 20 miles SE of Punta Icacos. This group is the farthest S on the barrier reef off the coast of Belize.

The barrier reefs extend about 32 miles NNE from Sapodilla Cays to Gladden Spit. Some of the cays in this area are not described, but the location of all the cays may be seen on the chart. Sapodilla Cays extend about 3.8 miles NE from Sapodilla Cay to Grass Cay.



**Sapodilla Cay**

**Sapodilla Cay** (16°05'N., 88°17'W.) has a conspicuous clump of coconut trees on it. Hunting Cay and Nicolas Cay, the middle cays of the group and which are separated by a passage through the reef, are densely wooded with coconut trees and are inhabited. There are numerous dangerous heads and irregular depths that range from 3.7 to 55m in an area that extends from 5 miles SW through 8.5 miles W of Sapodilla Cay. Several detached shoal patches, with depths of 7.3 to 17.4m, lie between 7.8 miles S through 6.5 miles SSW of Sapodilla Cay.

**Seal Cay** (16°10'N., 88°20'W.), an islet with a few trees on it, is located on the NE part of a small circular reef enclosing a lagoon. The former Seal Cays, 2.5 miles S, are reported to have been destroyed by a hurricane in 1945, and in 1972, only a sand bar remained. Shoal patches, with depths of 4.6 to 8.2m, lie in the area W and N of the ledge and extend up to about 4 miles off.

**Lawrence Rock** (16°10'N., 88°24'W.), with a least depth of 1.2m, lies about 3.3 miles W of Seal Cay. This rock is dangerous because the water over it is not sufficiently discolored to indicate its position. A 5.5m coral patch, about 1 mile SSW, and an 11m patch, about 1.8 miles WNW, of Lawrence Rock are the SW dangers on the E side of the entrance of Inner Channel or Main Channel. The ground is foul between Lawrence Rock and Seal Cay.

Between Sapodilla Cays and Gladden Spit, the barrier reef is generally broken and there are numerous cays, rocks, and openings along its entire length.

**6.55 Ranguana Cay** (16°20'N., 88°10'W.) lies about midway along this section of the reef and about 1.3 miles from the seaward side. Trees up to 15.2m high cover the cay. Ranguana Entrance, an opening through the reef about 0.3 mile wide, lies about 1.5 miles SE of the cays. There are depths of 6.1 to 7.3m



**Seal Cay Islet**

in this passage.

**Pompion Cay** (16°24'N., 88°06'W.), actually a group of wooded islands, stands about 4.8 miles NE of Ranguana Cay and is reported to be inhabited.

Little Water Cay and Hatchet Cay, both wooded, lie about 3 miles N and 4.3 miles NNE of Pompion Cay. The two cays have been reported to be good radar targets.

**Gladden Spit** (16°31'N., 87°59'W.) is the E projection of the barrier reef. This spit has been reported to lie about 2 miles E of its charted position.



**Gladden Spit**

The entrances to Gladden Cay and Queen Cay lie about 1.5 miles and 4.5 miles SW of Gladden Spit and have least charted depths of 2.5m and 4m. These openings lead to Inner Channel or Main Channel through narrow intricate passages. They should not be attempted without local knowledge or the services of a pilot.

Victoria Channel is the navigable passage which lies between the dangers extending E from Bugle Cays and those extending W from Gladden Spit. Victoria Channel may be used as an alternate route to Inner Channel or Main Channel and is

the passage through which vessels passing through the barrier reef by Queen Cay Entrance, Gladden Entrance, and the smaller openings in the reef to the S can reach Inner Channel or Main Channel.

For about 14 miles, to South Cut, the barrier reef extends NNW in a solid coral barrier, with no cays; then for about 6 miles farther NNW to Water Cay, it is broken, with numerous dry sandbanks and some above-water rocky heads. There are several cuts along this part of the barrier reef, which are available to small vessels with local knowledge. The W side of the reef is irregular and the area W to Inner Channel or Main Channel is interspersed with numerous cays and shoals.

**6.56 South Water Cay** (16°49'N., 88°05'W.) is a fairly large, wooded cay, with trees about 18m high.



**South Water Cay**

**Blue Ground Range** (16°48'N., 88°09'W.) is a group of cays located on the W side of the barrier reef opposite South Water Cay and about 5.5 miles E of Sittee Point; they are about 2.5 miles in extent in a N and S direction.

**Tobacco Cay** (16°54'N., 88°04'W.), a small wooded cay, has trees on it which reach a height of 21m. The cay lies on the N side of Tobacco Cay Entrance, 5 miles N of South Water Cay.

Tobacco Reef, which is nearly dry in many places, lies between South Water Cay and Tobacco Cay Entrance.

Tobacco Cay Entrance is a 4m passage that leads W toward Tobacco Range, 1 mile W of the entrance; the passage leads to Inner Channel or Main Channel, and enters the channel about 2.5 miles N of Cocoa Plum Cay (16°53'N., 88°07'W.).

From Tobacco Cay to Glory Cay, about 12.5 miles N, the reef is almost continuous and practically dry; this section of the reef is known as Columbus Reef.

Cross Cay, with trees 18m high, and Columbus Cay, with trees 15m high, lie close W of the barrier reef 5 miles and 6.5 miles NNE, respectively, of Tobacco Cay. Several cays lie W of Cross Cay and Columbus Cay.

**6.57 Glory Cay** (17°06'N., 88°01'W.), small and sandy, is located 0.7 mile NW of Columbus Reef. Southern Long Cay, which is wooded, is located inside the barrier reef; it lies about 1 mile SW of Glory Cay.

From Glory Cay the barrier reef, which is broken in many places, trends NNW about 28 miles to Saint George's Cay. The



cays W of the barrier reef and NW to NNW of Glory Cay are wooded.

**Skiff Sand** (17°13'N., 88°03'W.), 1m high, lies 7.3 miles NNW of Glory Cay. Rendezvous Cay stands about 1.5 miles N of Skiff Sand in the middle of a break in the barrier reef; it is covered with bushes; coconut trees, 13.7m high, and a clump of palm trees, 14m high, stand on the cay.

The Bluefield Range, a group of mangrove-covered cays, stands near the W side of the barrier reef, WNW of Skiff Sand.

The barrier reef between Rendezvous Cay and English Cay, about 5 miles N, is broken and marked by numerous banks, cays, and coral reefs. Immediately N of English Cay is Eastern Channel.

Goffs Cay, 1.3 miles NNE of English Cay, is small and sandy; a coral head, which dries, lies about 0.5 mile SE of it.

**Paunch Cay** (17°24'N., 88°02'W.), which is barren, lies close to the edge of the reef about 3 miles N of Goffs Cay.

From Paunch Cay, the reef, which is steep-to, extends about 9.5 miles N to Saint George's Cay, skirting Drowned Cays at a distance of 1 to 2 miles.

Saint George's Cay lies about 2.5 miles N of Drowned Cays and about 1.5 miles within the edge of the reef; it is low and sandy and is easily identified by the houses and coconut palms on it.

**6.58** The dangers which lie off this part of the barrier reef consist of Glover Reef, Lighthouse Reef, and the Turneffe Islands.



**Glover Reef**

**Glover Reef** (16°50'N., 87°47'W.) lies with its S extremity about 13 miles NNE of Gladden Spit; it is about 14 miles long and 6 miles wide. It presents a barrier reef which is impassable, except for a small opening at its S extremity. A light is shown on the SW cay, near the opening in the reef. The reef is a large coral atoll with a number of low, wooded cays and soundings give little or no indication of approaching danger.

The N point of the reef is known as Amounme Point. A light is exhibited on the NE edge of the reef 4 miles SE of Amounme Point.

**Caution.**—Glover Reef must be approached with care, especially from the N, as the reef is low and not always visible from

a distance. A strong W current has been experienced on several occasions between Glover Reef and Lighthouse Reef.

**6.59 Southwest Cays** (16°43'N., 87°51'W.) are the farthest S of the five cays located on the S extremity of Glover Reef.

The opening, close W of Southwest Cays, will accommodate vessels with local knowledge and drafts up to 3.7m. Larger vessels can find temporary anchorage about 1.5 miles W of Southwest Cay, in depths of 11 to 12.8m.

**Lighthouse Reef** (17°16'N., 87°32'W.), the farthest E danger off this coast, lies about 13.5 miles NNE of the NE extremity of Glover Reef. The reef is steep-to and unbroken except in the vicinity of Half Moon Cay, and is marked by several cays.

Lighthouse Reef should be approached with caution, as there is considerable doubt about the exact position of the edges of the reef.



**Lighthouse Reef**

**Half Moon Cay** (17°12'N., 87°32'W.), marked by a light, lies within the reef near its SE extremity. It has been declared a National Bird Sanctuary and a Natural Monument. Numerous coral heads surround the islet, but there is a shallow opening about 0.5 mile to the W. The islet has been reported to be radar conspicuous. Blue Hole, a natural phenomenon situated near the center of the lagoon, is reported to have a depth of 140m and emits a strong odor of hydrogen sulfide.



**Blue Hole at Half Moon Cay**



**Half Moon Cay Light**

Good anchorage can be taken, in a depth of 9m, sand and mud, about 0.2 to 0.3 mile off the sandy beach on the S side of Half Moon Cay.

**Sandbore Cay** (17°28'N., 87°30'W.), a tree-covered islet, lies near the N extremity of Lighthouse Reef. Four small white buildings and a wooden jetty stands close to the lighthouse on the N side of the cay. Northern Cay, about 0.8 mile SW of Sandbore Cay, is wooded.

**6.60 The Turneffe Islands** (17°22'N., 87°51'W.), which lie about 12 miles W of Lighthouse Reef, are an extensive group of mangrove-covered islands and cays which lie on a coral and sand reef. The barrier reef surrounding these islands is about 30 miles long and up to 10 miles wide. These islands are so closely grouped together that from a distance they appear as one large flat island. It was reported (1964) that radar returns from Grand Point, the S end of the islands, may be easily mistaken for Cay Bokel.

The reef that fringes this group lies at an average distance of 0.5 mile off the E side and 1 mile off the W side. The reef on the W side is awash in many places, but the seaward edge on all sides is steep-to. There are several shallow openings and numerous lagoons between the various islands, which are used by small craft with local knowledge.

**Caution.**—The E side of the Turneffe Islands is charted from old surveys and should be approached with caution. A stranded wreck lies near position 17°17'N, 87°31'W.

**6.61 Cay Bokel** (17°10'N., 87°54'W.), a small patch of sand, stands at the S extremity of the reef extending S from Grand Point. A vessel reported grounding about 0.8 mile WNW of Cay Bokel Light.

There are several detached cays near the S extremity of the

reef, but from a distance they appear as part of the main group of islands. On one of these, Big Cay Bokel, there are several fishing lodges.

Several detached cays stand on the reef N of the main group of islands. Mauger Cay (17°36'N., 87°46'W.) is the northernmost. The lighthouse on this cay is prominent.

Good anchorage can be taken during E winds in depth of 16.5m, sand, with Cay Bokel Light bearing 103°, distant 0.8 mile. Vessels of moderate draft can anchor about 2.8 miles NNW of Cay Bokel off an opening between the cays. Great care is necessary not to get into depths of less than 9 to 11m and to avoid the numerous rocky patches.

In the vicinity of Glover Reef, Lighthouse Reef, and the Turneffe Islands, the currents during November, December, and January depend on the winds; a N current is experienced during W winds, while a S current is experienced with N winds.

During February and March, the currents usually set N at a rate of about 1.5 knots. In April and May, the currents usually set S, at a rate of 1.5 knots. In June, July, and August, the current usually sets N at a rate of 1.5 knots, which increases to 2 knots during September and October.

**6.62** From Saint George's Cay, the reef trends about 19 miles N to abreast the S end of Ambergris Cay; it is steep-to.

The area W of the barrier reef between these two cays is shoal; the general depths vary from 1.2 to 4.6m. Numerous cays are located in this shoal area; their position may best be seen on the chart.

**Ambergris Cay** (18°02'N., 87°55'W.) is low and swampy; its N end is separated from the mainland by Boca Bacalar Chico, a narrow boat channel, but the island appears to be part of the coast. The reef skirts Reef Point, the E extremity of the island, at a distance of 0.5 to 1.5 miles, then it gradually approaches the coast of the mainland about 9 miles N of Reef Point.

**Directions.**—Vessels proceeding N to, or S from, Belize or calling at places on the coast, can do so by Inner Channel or Main Channel, a deep channel between the cays on the W side of the barrier reef and the mainland. The least depth in the channel was reported to be 10.1m in 1972, but 7.3m should be considered as a prudent controlling depth.

To enter Inner Channel or Main Channel from the S, a vessel's position should be accurately determined to enable a course to be shaped to clear all the dangers S and W of Sapodilla Cay (16°05'N., 88°17'W.). East Snake Cay should be steered for bearing 339° and when it is about 4.3 miles distant, course may be shaped for The Narrows off Placentia Point (16°31'N., 88°22'W.). In approaching The Narrows, soundings will not indicate the position owing to the irregularity of the bottom.

In the vicinity of Monkey Shoal (16°23'N., 88°25'W.) a vessel should keep a little E of the track which passes near a 7.3m patch in Penguin Shoals area.

After passing about 0.5 mile W of Bugle Cay, a vessel should steer to pass about 3.8 miles W of Cocoa Plum Cay (16°53'N., 88°07'W.). From abeam this cay, a vessel should steer N for about 27 miles in charted depths of 14.5 to 18.5m, passing about 1 mile W of a 6m patch, 7.5 miles ENE of the mouth of the Manatee River, then steer mid-channel to the en-

trance to Southern Grennels Channel.

Vessels generally leave Belize in the evening in order to arrive off Placentia Point early on the following morning, so as to have full daylight while finding their way through The Narrows. With the establishment of lights on various points, and with proper precautions, vessels with local knowledge can make a safe passage through The Narrows.

**Caution.**—The current generally sets strongly toward the barrier reef, accompanied by a heavy swell, so that every possible caution should be observed in this area.

**6.63 Victoria Channel.**—Victoria Channel, about 45 miles in length, is an alternate route for approaching Belize City from the S. There are charted depths of 7.5m in and near this channel.

To enter Victoria Channel from the S, proceed as directed for Inner Channel or Main Channel. When in a position about 2.8 miles SE of East Snake Cay, a vessel should steer NE about 20 miles to a position about 3.3 miles S of Laughing Bird Cay (16°26'N., 88°12'W.). From this position, continue NNE to a position about 3 miles NE of the cay, when course should be changed to the N, passing 1 mile E of Moho Cay (16°30'N., 88°10'W.). Continue N about 1 mile until Quamino Cay (16°39'N., 88°13'W.) bears 330°, when it should be steered for. When abreast Crawl Cay, a WNW course should be steered to pass midway between the reefs extending N from that cay and the reef extending S from Quamino Cay. When a vessel is W of the S extremity of the reefs off Quamino Cay, follow the directions for Inner Channel or Main Channel to Belize City.

**Eastern Channel.**—When approaching Eastern Channel from the N, steer for a position about 7.5 miles W of Mauger Cay (17°36'N., 87°46'W.). Steer a SSW course to pass near mid-channel between the Turneffe Islands and the barrier reef until the lights on English Cay are in line 300°.

When approaching Eastern Channel from the S, steer for a position 2.8 miles S of Cay Bokel (17°10'N., 87°54'W.), then direct a mid-channel course between Turneffe Islands Reef and Rendezvous Cay, until the lights on English Cay are in line.



**English Cay Light**

To enter Eastern Channel, steer for the lights on English Cay, bearing 300°, until the E side of Water Cay (17°23'N., 88°04'W.) bears 340°. Alter course to this heading and main-

tain it until Eastern Channel opens WNW. Then proceed through the sinuous passage maintaining a mid-channel course until One Man Cay Channel is reached. The E entrance to One Man Cay Channel is about 0.2 mile wide between the reefs; each reef is marked by a light. Steer a NW course through the channel until Robinson Point (17°22'N., 88°12'W.), marked by a light, bears 233°, then steer as required to the anchorage.

Pilots will embark about 2 miles E of English Cay. It is reported pilots do not consider the lights in Eastern Channel satisfactory for nighttime passage and therefore night arrivals and departures should be avoided. However, freighters have made night arrivals using radar with no apparent difficulty.

## **Belize City (17°30'N., 88°11'W.)**

World Port Index No. 9590

**6.64** Belize City, a roadstead harbor with limited port facilities, stands between the coast and the barrier reef at the N end of Inner Channel or Main Channel. It can be approached as previously described. This city, which is the principal port of Belize, is situated on both sides of Haulover Creek, the S entrance of the Belize River. Berthing facilities in the port are available only for small craft. Other vessels handle cargo at the anchorages S of the city.

**Belize Harbor Home Page**

<http://www.portauthority.bz>



**Belize City**

**Winds—Weather.**—East and SE winds prevail from the middle of February to the end of September, with the greatest period of calm at the end of February. Northeast through NW winds prevail during the rest of the year. The average wind velocity is about 10 knots. Northers are most likely to occur in November and December, but they rarely exceed force 4 or 5.

**Tides—Currents.**—The current generally sets S through the harbor at a rate of 1.5 knots, but during the season of the northers this rate may increase to 3 knots. North currents which attain a velocity of 1.5 to 2 knots may be experienced during

the rainy season.

The mean range of the tide is negligible. East winds raise the water level and N winds lower it; however, during northers, the fall may be as much as 0.6 to 0.8m.

**Depths—Limitations.**—Belize City Harbor consists of a roadstead about 7.5 miles in extent, with depths ranging from 5.5 to 12.8m. The 5m curve within the roadstead follows the general trend of the W side of the barrier reef and The Flat on the S side of the roadstead. On the W side of the roadstead, the 5m curve extends up to 2 miles offshore; on the N side of the roadstead, it extends E to the barrier reef from a position about 0.5 mile S of Belize City.



Isolated patches NE of Belize City

There are many isolated patches within the roadstead, with depths from 3.4 to 5.5m; some of these patches are marked by lights. For their exact positions, refer to the chart.

There are several wharves lining the shore at Belize City, but none are available for deep-draft vessels. The Deepwater Pier (King Pier) is 800m in length, has a berthing face of 67m, width 21m and reported depth of 10.0m. There is a ro-ro berth on the NW side of King Pier with a reported depth of 4.7m.

An offshore oil terminal, formed by mooring buoys, lies 0.5 mile SE of the T-head pier, depth 6.0m. Vessels moor heading ESE. In the absence of tugs, difficulty may be experienced unless the weather is calm.

The controlling depth to the anchorage through Eastern Channel and One Man Cay Channel is 9.8m. It was reported (1981) that the maximum draft allowed in the harbor was 5.8m. It is also reported (2011) that a natural S-shaped waterway, well marked with day beacons, marks the entrance to Belize City and may take 2 hours to transit from the entrance to the anchorage area. In 2011, Buoy No. 2 was reported to be about 300m S of its charted position and Buoy No. 3 was missing.

**Aspect.**—A group of white tanks, stacks, and two high radio masts in the vicinity of Belize City are conspicuous from the offing.

**Pilotage.**—Pilotage is compulsory. The Belize City pilots maintain a station and a lookout on English Cay, about 14 miles SE of the port. Pilots are available 24 hours. Vessels awaiting a pilot should keep clear of the reefs because of the strong set of the current. An ETA should be sent 24 hours in

advance.

Vessels proceeding either N or S through Inner Channel or Main Channel must make prior arrangements with the Belize City pilots.

The pilots can be contacted, as follows:

1. VHF: VHF channel 16
2. Telephone: 501-227-2439
3. Facsimile: 501-227-3571
4. E-mail: [marine@portofbelize.com](mailto:marine@portofbelize.com)

**Anchorage.**—The pilot should be consulted as to the best anchorage for each vessel.

Belize Harbor—Anchorage Information		
Vessel Type	Draft	Location
Butane	8-13m	17°21'33"N, 88°12'09"W
Container	9m	17°24'42"N, 88°12'06"W
Cruise	8m	17°26'42"N, 88°11'22"W
Cruise	10m	17°26'00"N, 88°08'10"W
Cruise	4m	17°28'39"N, 88°10'09"W
Molasses	17m	17°20'21"N, 88°11'31"W
Sugar	9-10m	17°27'16"N, 88°06'27"W

### Belize City to Puerto Morelos

**6.65** The coast from the Belize CityBeli peninsula extends about 22 miles NNE to the Northern River, which may be considered as the W entrance point of Chetumal Bay. This coast is low and covered with mangroves which extend to the shore. Shoal water, interspersed with cays, extends up to 15 miles offshore.

Chetumal Bay is entered between the Northern River and Cangrejo Cay, which stands about 10 miles to the E. Ambergris Cay forms the SE side of Chetumal Bay and lies with its S extremity about 2 miles NE of Cangrejo Cay.

The coast from the S extremity of Ambergris Cay extends about 90 miles NNE to Punta Herrero and is low, flat, and densely wooded. Virtually all of this coast is bordered by a steep-to reef that extends from 1 to 1.5 miles offshore.

Banco Chinchorro, an extensive steep-to bank about 26 miles long, lies 16 miles off this coast.

No sheltered anchorages for deep-draft vessels are available along this coast.

**Caution.**—The shallow depths which extend off this part of the coast from Belize to Corozal as far as the barrier reef, about 13 miles E, limit this area to small craft.

**6.66** The Northern River connects Northern River Lagoon with the sea, but it is of no importance.

Peter's Bluff, a low cay covered with trees, lies with its S extremity about 2.5 miles N of Fort George; Riders Cay, an islet, lies close off its N extremity.

**Rock Point** (17°40'N., 88°15'W.) is located about 12 miles NNW of Fort George. Hicks Cays lie E of Rock Point and about midway between the coast and the barrier reef.

The barrier reefs E of Belize City to Ambergris Cay have been discussed.



**Banco Chincarro—Stranded Wreck (2005)**

The Chetumal Bay (Bahia Chetumal) coast, N of the entrance between Cangrejo Cay (17°52'N., 88°02'W.) and the Northern River, is low, swampy, and densely wooded, except between the Hondo River and the Rio San Jose, where there are some red cliffs and moderately-high land. The bay is entered through the barrier reef abreast the N extremity of Cay Corker (17°47'N., 88°01'W.) and Cangrejo Cay, 4 miles N.

An intricate channel, with a least charted depth of 1.8m, leads from the entrance to the mouth of the Hondo River. Parts of the channel are marked by stake beacons, but its use is recommended only to those with local knowledge.

**6.67 Corozal** (18°22'N., 88°24'W.), a small town, stands near the W head of the bay and is fronted by a small pier, with a depth of 1.2m alongside. Anchorage can be taken about 275m to the SE of the pier.

Consejo Point, about 8 miles NE of Corozal, is the S entrance point to the Hondo River. A small settlement stands nearby.

The Hondo River enters Chetumal Bay between Consejo Point and Payo Obispo, a settlement about 2.5 miles to the N. This river forms part of the boundary between Belize and Mexico, and is navigable by small craft with drafts less than 1.2m for about 70 miles. A bar, with a depth of 1.5m, fronts the river mouth.

**Payo Obispo** (Ciudad Chetumal) (18°30'N., 88°17'W.) is the site of a Mexican Naval Base, which maintains the radio station in the town.

A T-head pier, about 39.6m long and 24.4m across the face, with a depth of 1.8m alongside the face and 0.9m alongside its W side, extends from the shore abreast the town. Five lighters, up to 150 grt, and six tugs are used for loading and discharging cargo from vessels anchored off the W side of Cay Corker. No licensed pilots are available.

Chetumal Bay extends about 26 miles NNE from the Hondo River. It narrows at its N part; the Rio Kik flows into the N part of the bay.

**6.68 Boca Bacalar Chico** (18°11'N., 87°52'W.), a narrow boat passage, separates the N end of Ambergris Cay from the mainland.

Xcalax, a small coastal port, stands about 6 miles N of Boca Bacalar Chico. Vessels with local knowledge and drafts up to 4.5m can enter and anchor inside the reef, in a depth of about 5.5m. The bottom consists of mud, rock, and patches of white sand, providing good holding ground.

From Xcalax, the coast trends about 65 miles NNE to Punta Herrero; it is low, flat, and wooded, with the tops of the trees being about 18.3 to 24m high.

Nearly all of this stretch of the coast is fronted by a reef which lies from 1 to 1.5 miles offshore. There are several channels through the reef, but they should not be attempted without local knowledge.

**6.69 Banco Chinchorro** (18°35'N., 87°27'W.), a dangerous steep-to shoal, lies about 28 miles NE of Ambergris Cay and from 14 to 16 miles offshore. The greater part of the shoal has depths which range from 1.8 to 7.3m, with numerous rocky heads and sand banks. The stranded wrecks which lie along the E side of the shoal were reported conspicuous both visually and by radar. It has been reported that Banco Chinchorro is a good radar target for southbound vessels.

Cayo Lobos, a small cay about 0.8 mile inside the 200m curve, stands near the S extremity of Banco Chinchorro. Several openings, available only to small craft with local knowledge, cut through the reef to the W and NW of Cayos Lobos.

**Cayo Centro** (18°36'N., 87°20'W.) stands in the middle of Banco Chinchorro, about 1.5 miles from its E side. This low cay is composed of sand about 2.5 miles long and is covered with bushes and coconut trees. A salt water lagoon, about 1 mile long, lies in the middle of the cay. A strong, dangerous current sets into Firefly Bight, about 2 miles SE of Cayo Centro.

**Cayo Norte** (18°45'N., 87°19'W.), two long cays, lie within the reef about 1.5 miles S of the N extremity of Banco Chinchorro. Dense vegetation and trees, about 12.2 to 15.2m high, cover the cays. A disused lighthouse and building stand close S of the light on Cayo Norte.

There are a number of wrecks on the E side of the bank which have been reported to be radar prominent.

**Caution.**—In the vicinity of Banco Chinchorro there is usually a very strong current that sets toward its entire E side.

The passage between Banco Chinchorro and the coast W is clear of dangers and has depths of 183 to 1,024m.

**6.70 Puerto Costa Maya** (18°43'N., 87°42'W.) is a small port designed for the cruise ship industry. The port was built to support tourism and can accommodate up to three cruise ships simultaneously.

**Depths—Limitations.**—Berthing is comprised of a jetty 390m in length connected to a pier 340m in length. For berthing information see the table titled **Puerto Costa Maya—Berth Information**.

Puerto Costa Maya—Berth Information			
Berth	Length	Draft	Remarks
No. 1	330m	12.5m	E side of pier
No. 2	330m	10.0m	W side of pier
No. 3	300m	10.0m	S side of jetty

**Pilotage.**—Pilotage is compulsory for all vessels, except Mexican vessels under 500 grt. Notice of ETA should be sent 24 hours prior to arrival by e-mail, and confirmed 1 hour prior to arrival via VHF Radio. The pilot boards 1.5 miles E of the Costa Maya Berth No. 1 (18°43.8'N., 87°42.0'W.).

The pilots can be contacted, as follows:

1. VHF: VHF channels 16 and 72
2. Telephone: 5201-983-8345-986
3. E-mail: [cap.elizondo@usa.net](mailto:cap.elizondo@usa.net)  
[cap.elizondo@prodigy.net.mx](mailto:cap.elizondo@prodigy.net.mx)

**6.71 Punta Herrero** (19°18'N., 87°26'W.), the S entrance point of Bahía del Espíritu Santo, is fronted by foul ground which extends up to about 1 mile offshore. In the entrance of the bay to the N the area is generally foul.

**Bahía del Espíritu Santo** (19°22'N., 87°28'W.), entered between Punta Herrero, which is marked by a light, and Punta Tupac about 11 miles N, recedes about 16 miles SW and is about 7 to 10 miles wide. The depths in the entrance and for a short distance within the bay range from 6.1 to 9.1m, but in 1943, it was reported that the actual depths in this area were 13.7 to 14.6m. The general depths within the bay range from 2.4 to 4.6m, about 2.8 miles NW of Punta Herrero.

There is anchorage, in a depth of 4m, within the outer part of the bay under the reefs at the entrance.

From Punta Tupac, the coast, which is bordered by a rocky ledge, trends about 7.8 miles NNE to Punta Pajaros (19°34'N., 87°25'W.). A drying reef extends about 0.5 mile E from Punta Pajaros, which is also marked by a light.

Depths of less than 9.1m lie up to 0.6 mile off this part of the coast, and depths of less than 200m extend between 1 mile and 1.3 miles offshore.

**Bahía de La Ascension** (19°41'N., 87°30'W.) is entered between Punta Hualaxtoc (Punta Nohku) (19°37'N., 87°28'W.), about 3.3 miles NW of Punta Pajaros, and Punta Allen, about 8 miles N. The bay recedes about 16 miles SW and is from 5 to 11 miles wide.

The entrance of the bay is obstructed by a bar with a depth of 2.4m. Cayo Culebra consists of a group of mangrove cays which stand in the middle of the entrance just within the bar.

Two yellow range beacons stand on these cays. An opening about 2 miles wide leads through the reef stretching across the entrance. Depths of 5.5 to 6.7m are found in this opening and as far W as the seaward side of the bar. There are depths of 3 to 5.5m within the bar, but the inner reaches of the bay have not been examined.

The opening between Cayo Culebra and Punta Hualaxtoc is shallow and should not be attempted. The opening N of Cayo Culebra is about 3.8 miles wide.

**6.72** The coast between Bahía de La Ascension and Punta Yaan is quite regular, low, and densely wooded.

**Punta Yaan** (20°11'N., 87°27'W.) is conspicuous as the only cliffs along this coast are located here. They are about 24m high and front the coast for about 3 miles. The ruins of a large square watchtower stand at their N end.

Tancah, a small settlement fronted by a white sandy beach, stands about 4 miles NNE of Punta Yaan. A conspicuous, small stone temple on a truncated pyramid stands about 0.5 mile inland and is overgrown with vegetation. A small pier extends from the shore abreast of the settlement.

The coast between Tancah and Puerto Morelos extends about 45 miles NE and again becomes low and flat. The trees along this part of the coast are about 15m high.

The only known off-lying dangers are Isla de Cozumel and Cozumel Bank, which together front this coast for almost 30 miles and lie from 9 to 13 miles offshore.

## Isla de Cozumel

**6.73 Isla de Cozumel** (20°26'N., 86°53'W.), low and densely-wooded, extends 24 miles NE from its S extremity, which lies 25 miles ENE of Punta Yaan. The average width of this island is about 9 miles. Isla de Cozumel is a major tourist center.

Punta Celerain (South Point), low, but defined, is fringed by a steep-to reef which extends about 0.5 mile offshore. A light is shown from the point.

The E side of the island, composed of sandy beaches separated by rocky points, extends about 24 miles NE to Punta Molas. The 200m curve lies about 1 mile offshore.

The W side of the island extends about 8 miles NNW and then about 13 miles NNE to its NW extremity. The 200m curve lies from about 0.8 to 0.5 mile offshore. The shore is bordered by a narrow coral beach and vegetation extends almost to the waters edge.

Caleta Bay, a small fairly deep body of water, lies about 8 miles SSW of the NW extremity of the island (3 miles SSW of San Miguel). The entrance channel is narrow and shoal. A wharf, some buildings, and fuel tanks stand on the shores of the bay, and a conspicuous hotel stands close SW of it.

The passage between Isla de Cozumel and the mainland to the W has depths of 200m and is clear of dangers.

**6.74 San Miguel de Cozumel** (20°30'N., 86°58'W.) (World Port Index No. 9550) stands about 3 miles NNE of Caleta Bay. It is the principal settlement on the island. It was reported that San Miguel is a free port.

**Tides—Currents.**—Strong currents of up to 3.5 knots have been reported (2000) in the vicinity of the pier.

**Depths—Limitations.**—The International Pier (Muelle Consorcio), formerly known as Muelle del Transbordador, is situated about 1 mile NE of Caleta Bay. The pier can accommodate deep-draft and cruise ships. A second L-shaped pier, Muelle Terminal TMM, stands close NE of the International Pier. There are facilities for ro-ro vessels; a vehicle ferry runs to the mainland. For berthing information see the table titled **San Miguel de Cozumel—Berth Information**.



**International Pier (Muelle Consorcio)**



**Cozumel—New Lighthouse**



**Cozumel—Conspicuous Hotel and Water Tower**



**Cozumel—Flagpole**

**Aspect.**—A new light tower stands NE of the International Pier and SW of the old decommissioned lighthouse.

<b>San Miguel de Cozumel—Berth Information</b>			
<b>Berth</b>	<b>Length</b>	<b>Draft</b>	<b>Remarks</b>
Mulle Fiscal	165m	3.3m	Concrete pier located 0.5 mile NE of San Miguel de Cozumel Light.
Dolphin Berth	—	—	Small tankers. Located close to San Miguel de Cozumel Light.

San Miguel de Cozumel—Berth Information			
Berth	Length	Draft	Remarks
Punta Langosta	600m	—	Passenger vessels. L-shaped pier extends NNE from shore. Located NW of Governors Palace.
International Pier	244m	12.0-14.0m	L-shaped ro-ro pier located 2.5 miles S of Muelle Fiscal.
Muelle Puerto Maya	—	10.0-11.0m	

A conspicuous hotel stands close E of the International Pier. A conspicuous clock tower, painted white and dimly illuminated at night, stands near the root of the pier at the town of San Miguel. A blue-domed water tower and a framework radio tower, both conspicuous, stand close NE and 0.5 mile SW, respectively, of the clock tower. A prominent airport control tower stands about 1.5 mile NE of the town.

**Pilotage.**—Pilotage is compulsory and is available during daylight hours only. Pilots board about 3 miles NW of the berth, or as requested.

**Anchorage.**—There is good anchorage off San Miguel, in depths of 9 to 11m, from 0.1 to 0.2 mile offshore. Four berths are available. Use of the anchorage should take into account the proximity of the airport runway. It is inappropriate to use the anchorage closest to the runway when a NW wind is blowing.

Additional anchorages are available off the Town Quay at Playa del Carmen on the mainland. These are overflow anchorages for use when the port is crowded and vessels are waiting to enter.

**Caution.**—A dangerous wreck (position approximate) lies about 0.3 mile N of the lighthouse.

A submarine cable, marked by six yellow buoys, was reported (1999) to run from the island to the mainland. The cable terminates on the island close SW of the town of San Miguel.

Submarine cables extend from N of San Miguel to the mainland at Playa del Carmen and are best seen on the chart.

**6.75** Punta Norte, the NW extremity of the island, lies about 3.3 miles NE of the entrance to Banco Playa yacht harbor. The shore between is lined with numerous hotels one of which, a white building, is conspicuous and can be seen from a considerable distance seaward.

The N side of the island extends about 10 miles ENE from its NW extremity to Punta Molas. A conspicuous clump of coconut trees stands about 2.5 miles E of the NW extremity of the island. A reef extends up to 1.8 miles offshore; the 10m curve lies up to 2.8 miles offshore. Some coral heads lie within this latter curve. La Laguna, an almost landlocked body of water, lies across the N part of the island.

**Punta Molas** (20°35'N., 86°44'W.), the NE extremity of the island, may be identified by a tall isolated tree and some huts. The point is marked by a light.

Cozumel Bank extends N from the N side of the island and lies up to 6 miles N of Punta Molas. The bank has been reported to extend up to 14 miles NNE and 4 miles E from Punta Molas. General depths on the bank range from 9.1 to 40m. Ripples, which at times have the appearance of breakers, mark the E edge of this bank.



**Punta Molas Light**

### Puerto Morelos to Cabo Catoche

**6.76** **Puerto Morelos** (20°51'N., 86°54'W.) is a small fishing and ferry port with depths of 6.7 to 10.1m. The village of Puerto Morelos stands on the mainland about 1.5 miles N of the entrance and is protected by reefs which lie 0.3 mile offshore abreast the village and up to 1 mile offshore abreast the S part of the harbor. Some of these reefs are 0.6 to 0.9m high in places. A small pier, with a depth of 4.9m alongside its head, extends from the shore N of the village.

The coast should be approached from the E to a position about 1.8 miles S of the light, which stands N of the village. When this light bears 024°, a vessel should steer for it on that bearing, which leads over a least charted depth of 7.9m, but depths of 1.8m less than charted have been reported in this channel. It has been reported (2009) that this light may be in-



operative.

Anchorage can be taken abreast the village, in depths of 8 to 9m, but it is advisable that vessels moor.

The coast between Puerto Morelos and Cabo Catoche extends about 14 miles NE and then curves NNW for 36 miles to Cabo Catoche. The terrain is generally low and wooded. Sand hills stand along some parts of the coast. The terrain in the N part of this area becomes more elevated, with trees up to 40m above the sea.

**Caution.**—The 200m curve, which lies about 2 miles SE of Puerto Morelos, gradually extends from the coast and lies about 37 miles E of Cabo Catoche.

The coast about 5 miles SW of Puerto Morelos is fringed by a steep-to reef which extends up to 1.3 miles offshore.

Numerous islands, cays, and other dangers lie within the area enclosed by the 200m curve, which lies between 1 mile and 15 miles offshore between Puerto Morelos and Cabo Catoche.



**Isla Cancun**

**6.77 Isla Cancun** (21°05'N., 86°47'W.) stands about 14 miles NNE of Puerto Morelos and is composed of sand hills 12 to 18m high. The N and S extremities of this island curve to the W and almost reach the mainland. There are two bridges connecting the island with the mainland. A 1970 report stated that the S end of the island appeared to be connected to the mainland when viewed by radar.

A conspicuous tower, marked by a red fixed obstruction light, and a structure in the shape of a truncated pyramid stand near Punta Cancun. Another tower, marked by a red fixed ob-

struction light, stands 2.8 miles SSW of the point.

Isla Cancun encloses a series of interconnected lagoons having shallow channels to the sea. A natural harbor for small craft is located S of Punta Nizue, the S extremity of the island, and is protected by a reef. Local knowledge is required to enter it.

**6.78 Isla Mujeres** (21°14'N., 86°45'W.), which stands about 4.5 miles NNE of Isla Cancun, is about 4 miles long, low, narrow, and wooded. The S part is slightly elevated and has trees about 27m above the sea. The ruins of a square watch tower stand near the S part of the island. The E side of the island is composed of fairly steep-to rocky shelves and terminates at its N end in Roca El Yungue (Anvil Rock), which is square, black, and about 1.8m high. Some white cliffs stand about midway along the E side of the island. A large, square white hotel stands on the N extremity of the island and has been reported to be a good radar target.

Puerto Juarez, a small town on the mainland, stands about 5.5 miles WSW of the light on the S end of Isla Mujeres. The town serves as a terminal for ferries servicing Isla Mujeres. A pier, about 244m long, with a depth of 1.8m alongside, extends from the shore abreast of the town. A ferry service for vehicles operates from Punta Sam, 3 miles N of Puerto Juarez.

**6.79 Bahía de Mujeres** (21°13'N., 86°46'W.) lies between Isla Mujeres and the mainland; it is entered between the NE extremity of Isla Cancun and the S extremity of Isla Mujeres.

A sand bank extends about 2 miles W from the S extremity of Isla Mujeres, then trends N about 2 miles toward the island; the 5m curve marks this sandbank. There are many coral heads on this bank; some of them near the S end nearly dry. The SW edge of this bank is marked by a lighted buoy.

A passage between this bank and the shoals W is about 0.3 mile wide and leads N past Puerto Mujeres, where it joins Canal las Pailas, passing N of Isla Mujeres to deep water about 0.5 mile N of Roca El Yunque.

The general depths in the area between Isla Mujeres and the mainland are from 2 to 8m; only vessels with local knowledge should attempt this passage.

A charted submarine cable and aquaduct cross the bay between Punta Sam and Isla Mujeres.

**Puerto Mujeres** (21°16'N., 86°45'W.) is situated at the N end of Isla Mujeres, on its W side. The harbor lies in a small bay entered between the NW extremity of the island and Roca La Carbonera, about 0.5 mile S. A channel for small vessels leads through the shoal which extend across the entrance to the bay. There are six quays, with depths of 2.4m, and a ferry berth in the bay.

There is an anchorage in Bahía de Mujeres, about 2.3 miles W of the S extremity of Isla Mujeres, in depths of 6 to 7m.

**6.80 Arrowsmith Bank** (21°05'N., 86°25'W.) lies about 16 miles E of Isla Cancun. The bank is about 17 miles long and from 1.5 to 5 miles wide. There are depths to 16.4 to 38m, with the shallowest part lying on the center of its E part.

The E edge of the bank is reported (1981) to lie about 4 miles farther E than charted.

A NNE current sets across Arrowsmith Bank, attaining a rate of from 2 to 3 knots; the S end of the bank is marked by strong ribs.

In 1980, it was reported that an area of heavily breaking seas was observed, centered in position 20°50'N, 86°35'W, S of Arrowsmith Bank; there was a moderate SE wind at the time of the observation.

A shoal, with a depth of 8.2m, was reported (1960) to lie near the NE extremity of Arrowsmith Bank.

From a position on the coast about 5 miles W of the S extremity of Isla Mujeres, the coast trends about 3.5 miles N to a narrow ridge of sand about 2m high, which connects a narrow neck of land about 4 miles long with the mainland. The continuation, about 5 miles farther N, is known as Isla Blanca (21°22'N., 86°49'W.).

From the S end of the ridge of sand, a reef fringes the coast, extending past Isla Blanca to Isla Contoy, about 4 miles farther N; there are one or two openings for boats in it.

**6.81 Isla Contoy** (21°30'N., 86°49'W.) stands about 4 miles NNE of Isla Blanca and 6.5 miles offshore. Its E side is

composed of a narrow ridge of sand hills covered with bushes and trees to within 1.5 miles of its NW extremity. A narrow ridge of coral, with depths of 5.5m, extends about 3 miles NNW from two rocks close off the NW extremity of the island. The greater part of the W side of the island is intersected by numerous small lagoons. The island is a bird sanctuary.

A bank, with a depth of 27m, was reported (1946) to lie about 17 miles ENE of the N extremity of Isla Contoy. A shoal depth of 18.3m was reported (1968) to lie about 16 miles NE of the N end of the island.

From **Cayo Sucio** (21°25'N., 86°53'W.), which lies close off the coast 3 miles NW of Isla Blanca, the coast trends about 8 miles NW. This coastal section is more elevated and densely wooded, with some trees standing 37 to 40m above the sea. The conspicuous ruins of a church stand at the N end of this stretch of coast. From the ruins of the church, the coast extends about 6 miles WNW to abreast Cabo Catoche, which is the N extremity of Isla Holbox.

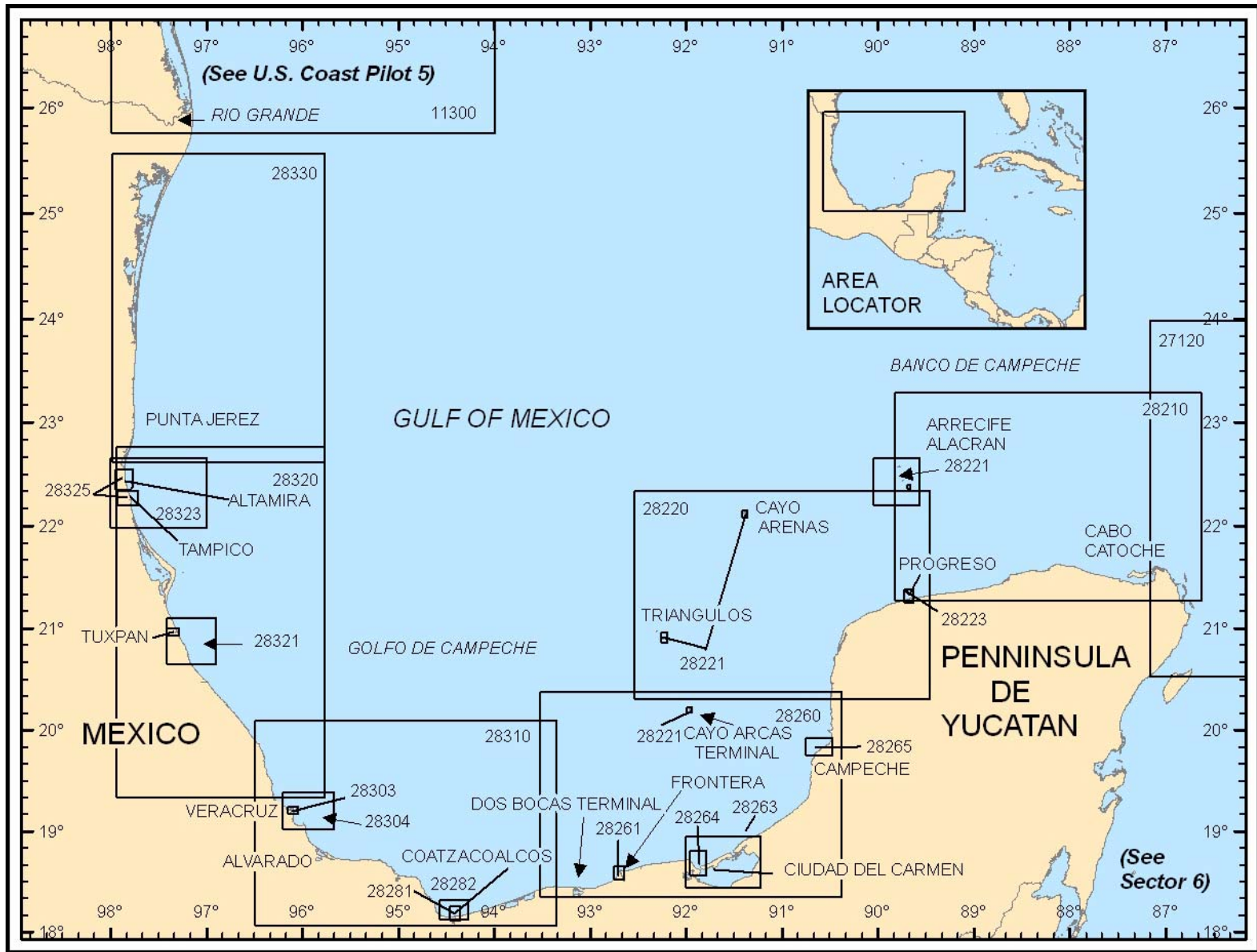

Additional chart coverage may be found in NGA/DLIS Catalog of Maps, Charts, and Related Products (Unlimited Distribution).

**SECTOR 7 — CHART INFORMATION**

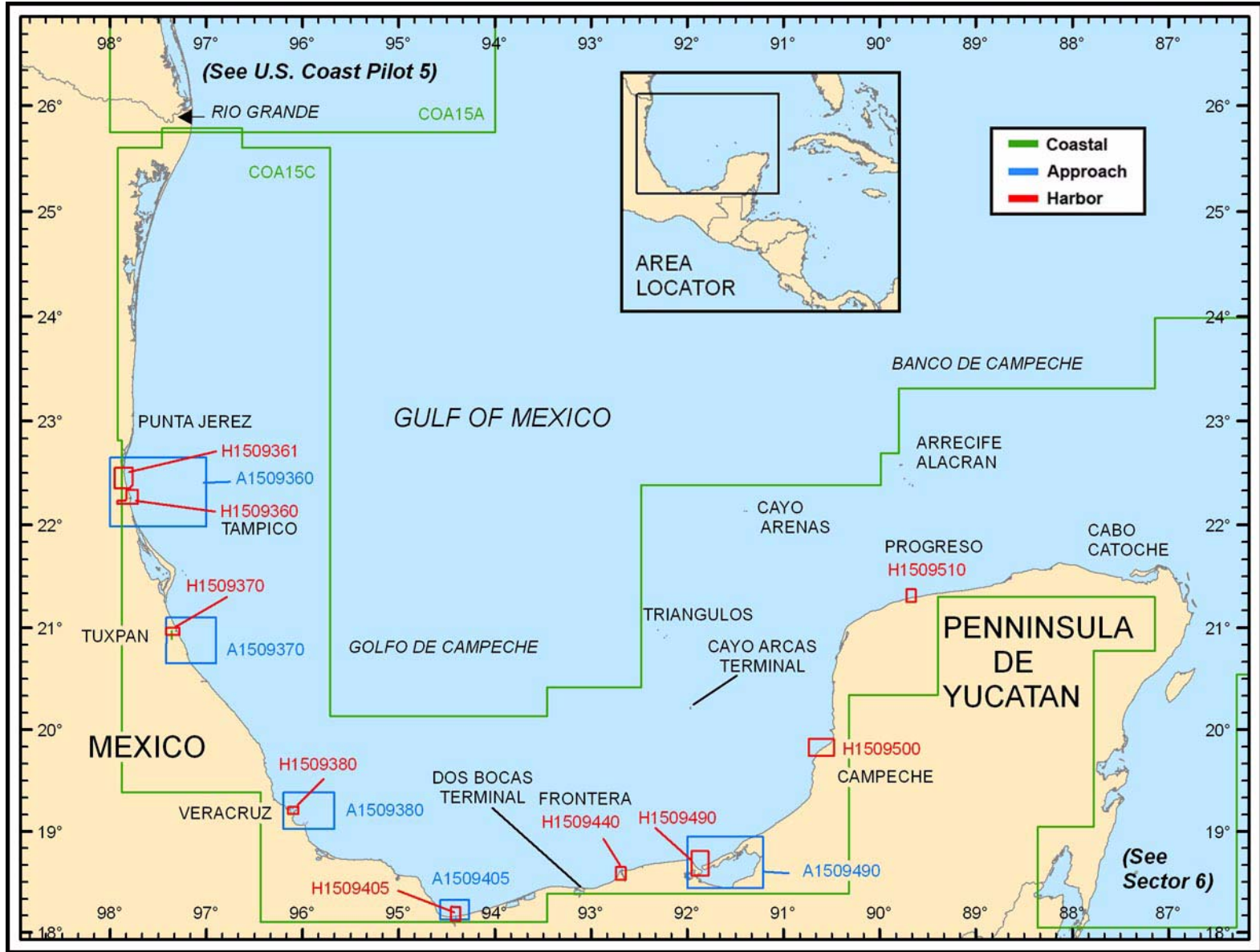

Additional DNC library coverage may be found in NGA DNC 15 (Limited Distribution) disc within the README\GRAPHICS folder.

SECTOR 7 — DNC LIBRARY INFORMATION

## SECTOR 7

### COAST OF MEXICO—CABO CATOCHE TO THE RIO GRANDE

**Plan.**—This sector describes the coast of Mexico from Cabo Catoche W along the N coast of Peninsula de Yucatan, then S and W around the shores of the Bay of Campeche, and then N to the Rio Grande.

#### General Remarks

**7.1** The E coast of Mexico between Cabo Catoche and the Rio Grande extends WNW for 615 miles.

Peninsula de Yucatan, which forms the SE side of Mexico, has as its E side the coast between Chetumal Bay and Cabo Catoche. The N coast of the peninsula extends in a general W direction for about 190 miles between Cabo Catoche and Punta Boxcohuo. The W side of the peninsula extends 105 miles S from Punta Boxcohuo and then an additional 78 miles SW to the W entrance of Laguna de Terminos. The N and W sides of the peninsula are low and arid, and have very few conspicuous landmarks.

Banco de Campeche, an extensive coastal bank, as defined by the 200m curve, extends up to 155 miles N from the N side of Peninsula de Yucatan and as far as 120 miles from the W side of the peninsula. This bank is very steep-to, has irregular depths, and many cays, shoals, and reefs are found within its limits.

Between Punta Boxcohuo, the NW extremity of the peninsula, and Cabo Rojo, 390 miles W, the coast recedes 195 miles S to form the Bay of Campeche. The E side of the gulf is formed by Peninsula de Yucatan, the S side by the coast between Laguna de Terminos and Punta Zapotitlan, and the W side by the coast between Punta Zapotitlan and Cabo Rojo. The low E and S coasts of the gulf are indented by several lagoons. The coastal plain on the W side of the gulf is backed by mountain ranges rising 10 miles inland. The S and W parts of the gulf have regular depths and few off-lying dangers. Numerous rivers discharge into the gulf along its S and W shores.

From Cabo Rojo, the E coast of Mexico extends farther N for 270 miles to the Rio Grande. This section of coast is marked at irregular intervals by low sand hills and wooded hummocks. Several large lagoons lie adjacent to the coast. Ranges of hills, several of which make good landmarks, stand farther inland.

Puerto Veracruz, Tampico, and Coatzacoalcos are the principal ports for large vessels, but there are also several small ports for vessels with shallow drafts.

**Winds—Weather.**—The prevailing winds come from directions between the NE and SE, but are interrupted by northers during the cooler months of the year and by tropical cyclones from June to November. Northers generally last about 1 to 2 days, but severe storms last for 2 to 5 days.

Along the E and N coasts of Peninsula de Yucatan, the trade wind freshens in the afternoon and diminishes and shifts to the SE late at night and in the early morning.

Along the W coast, from 1000 to 1400, the interval of change from the land to the sea breeze, the wind falls gradually

to nearly a calm and gradually springs up again from the N, and at about 1500 is established from the NE.

Rainfall varies from 500 to 1,000mm along the coast. Progreso has an average annual fall of 470mm. Precipitation is heaviest near Coatzacoalcos and decreases in both directions along the coast. In general, the maximum occurs in September.

Ships' observations taken in the area between the coast and 20°N, 95°W show early winds predominate for all months but September, October, and November, when the prevailing wind is NE. Average wind velocities range from 8 to 12 knots, being somewhat higher from October to March. Gales are most frequent in October and November, when 4 per cent of observations report winds of force 8 or higher.

In the vicinity of Puerto Veracruz and N to 25°N, the prevailing winds are E, with a large percentage of N winds from September to April. The latter period, but more especially beginning with October, is known as the norther season, when the trades are frequently interrupted by northers. The remainder of the year is known as the trade wind season.

Wind velocities average considerably higher during the months of October through April, being highest in December, when ships' observations show an average velocity of 12 knots.

Fog is frequent, but most likely in March.

The climate is hot and humid, although the oppressiveness is considerably lessened during the norther season when cool N winds are felt.

**Tides—Currents.**—The main offshore current sets W across Banco de Campeche, 20 to 30 miles from the N coast of Peninsula de Yucatan, at a velocity of 0.5 to 1.5 knots. It then sets SW across the Bay of Campeche and N, following the trend of the coast to the Rio Grande, 20 to 30 miles offshore, decreasing somewhat in velocity. From October to May, the current circles the Bay of Campeche in a counterclockwise direction a distance of 10 to 30 miles offshore at a rate of 0.3 to 0.5 knot.

Off the mouth of the Rio Grande and anywhere within 100 miles of the coast, the current is mainly governed by the prevailing wind, setting N in the summer and S in the winter.

#### Banco de Campeche

**7.2** Banco de Campeche extends 155 miles N from the N coast of Peninsula de Yucatan and 120 miles W from its W side.

From a position lying 35 miles E of Cabo Catoche, the 200m curve, which defines the limits of this bank, extends N and NW for 170 miles, then irregularly W and SW to a position lying 140 miles NW of Punta Boxcohuo. It then extends S quite regularly at a distance of 120 miles off the W side of the peninsula.

From a position lying 14 miles N of Cabo Catoche, the 20m curve extends W along the N side of the peninsula at a distance of 12 to 18 miles offshore to a position lying 24 miles N of

Punta Boxcohuo. On the W side of the peninsula, the 20m curve extends SW and S at a distance of 20 to 38 miles offshore. All of the dangers contained within this curve are described under the principal description of the coastal features. This steep-to bank has very irregular depths and is marked on its E and N edges by heavy ripples and a confused sea. Some of the dangers within the limits of the bank are marked by discolored water.

Banco de Campeche has not been surveyed for many years and, as reports of new shoals are constantly received, it is reasonable to assume that many more dangers exist than are shown on the charts.

The following shoals were reported in the years indicated with the distances and bearings from Cabo Catoche (21°36'N., 87°04'W.):

1. A 6.4m shoal (1932), 13 miles N.
2. An 18m shoal (1968), 25.5 miles ENE.
3. A 12.8m shoal (1960), with a 16.5m depth (1967) close E of it, 38 miles NNE.
4. A 25.6m patch (1973), 33.5 miles NE. Several shoals, with depths of 27 to 58m, lie within 6 miles N through NE of this shoal.
5. A depth of 11m (1971), 58 miles N.
6. A depth of 22m (1957), 61 miles N.
7. A shoal bank, with depths of 110 to 200m (1959), about 120 miles N. An 8.2m patch was reported (1961) to lie on the S end of this shoal bank.
8. A 14.6m depth (1968), 111 miles N.
9. A 27.4m depth (1946), 30 miles E.

The following shoals were reported in the years indicated with the distances and bearings from Punta Yalkubul (21°32'N., 88°37'W.):

1. A small shoal patch (1921), depth unknown, 39 miles NNE.
2. Aeolus Shoal, with a depth of 9.1m, 31 miles N.
3. Iphigenia Rock, with a depth of 14.6m, 26 miles N.
4. Bajos Nortes, two coral banks with depths of 20.1 to 36.6m, lie 5 miles apart, 100 miles N. A 5.5m patch was reported (1907) to lie on the southern most bank.
5. Granville Shoal, with a depth of 8.2m, about 45 miles WNW. A 12.8m patch lies 10 miles N of Granville Shoal. A 17.4m patch lies 20 miles SSW of Granville Shoal.

**7.3 Arrecife Alacran** (22°29'N., 89°42'W.), a steep-to half-moon shaped reef, lies 34 miles NW of Granville Shoal. The reef covers an area extending 14 miles N and 10 miles E. The NE side of the reef is composed of a compact mass of coral, awash, on which the sea breaks heavily. The SW side is composed of detached coral heads and sandbanks, with deep water between some of the features. Soundings give no indication of the proximity of the reef. Isla Chica and Isla Pajaros, two small low cays lying 0.3 mile apart, stand near the S end of the reef. Isla Desterrada, a small cay 3m high marked by a light, is located 3 miles within the N edge of the reef.

Isla Perez, a narrow cay 0.5 mile long and 4.3m high, is located 1.8 miles within the S edge of Arrecife Alacran. This cay is marked by a light with a racon. The light tower is fully visible when approaching from the W and is reported to be radar conspicuous. A gray masonry tower stands adjacent to the light tower.

Anchorage can be taken by small vessels, in depths of 11 to 18m, fine sand, mud and coral, about 0.3 mile E of Isla Perez. The anchorage is approached from the S through an unmarked channel with a depth of 7.3m. This channel should not be attempted without local knowledge. In 1977, a vessel with a draft of 5.5m anchored about 2 miles, bearing 093°, from Isla Perez Light, in a depth of 44m, good holding ground.

Isla Desertora, a small cay 4m high, lies 3 miles NW of Isla Perez.

The current usually sets W in the vicinity of Arrecife Alacran at a rate of 1 knot, but may set N or S, depending on the direction of the wind.

**Arrecife Madagascar** (21°26'N., 90°18'W.), a narrow coral ledge, with a least depth of 2.7m, lies 69 miles SSW of Arrecife Alacran. The sea does not break on this ledge, which is covered with weeds and appears the same color as the water. Two 12.8m patches lie 2 miles and 3 miles W of the ledge.

Breakers were reported (1909) about 6 miles NNE of Arrecife Madagascar.

Arrecife de La Serpiente (Snake Rock), with a least depth of 8.2m, lies 11.5 miles W of Arrecife Madagascar.

**7.4 Cayo Arenas** (22°07'N., 91°24'W.), a guano-covered cay 6m high, lies on the SE edge of a detached reef, 0.8 mile long. A ledge extends 5 miles W from the cay. The horns of the reef extend 0.5 mile NW and 0.3 mile W from the cay. A small wharf stands on the NW side of the cay. A detached reef, 1.3 miles long, with a rocky patch, 2.1m high, on its S end and a small coral patch, 0.6m high, off its NW end, lies 1 mile E of Cayo Arenas. A stranded wreck lies 0.2 mile W of a light, with a racon, which stands on the reef. The intervening channel is about 0.5 mile wide at its N entrance. At its S end lie three coral patches, with a depth of 4.1 to 8.2m, about 0.3 mile SE of Cayo Arenas.

A 11m patch was reported (1968) to lie about 15 miles ENE of Cayo Arenas. A 14.6m patch lies 3 miles W of the same cay and a 29.2m patch lies 19 miles E of the cay. A shoal, with a least depth of 27.4m, lies about 18 miles ENE of the cay.

Several shoals, with depths between 14.6m and 21.9m, lie between 29 miles and 53 miles SSE of Cayo Arenas. Shoal patches, with depths of 12.8m and 18.3m, lie 60 miles SSW and 54 miles SW, respectively from Cayo Arenas.

A detached pinnacle, with a depth of less than 20m, was reported (1961) to lie 24 miles NW of Cayo Arenas. A detached bank, with depths of 45.7 to 54.9m, was reported (1911) to lie 43 miles NNW of Baja Nuevo. A depth of 23.7m was reported (1982) to exist 13 miles WNW of Baja Nuevo.

**Anchorage.**—Anchorage may be found as charted in the channel, in depths of 15 to 27m, close E of the light.

**7.5 Cayo Nuevo** (21°50'N., 92°05'W.), with a depth of less than 1.8m, lies 40 miles WSW of Cayo Arenas and is marked by breakers. Depths of less than 36m extend up to 5 miles off the reef's NE side and up to 3 miles off the other sides of this reef. A detached 18.3m patch lies 25 miles NNW of Cayo Nuevo. A depth of 23.5m was reported (1982) to exist 13 miles WNW of Baja Nuevo.

**Banco Ingleses** (21°49'N., 91°56'W.), two banks of coral and sand with depths of 9 to 34m, lie with their shallowest part located 8 miles SE of Cayo Nuevo.

**Arrecifes Triangulos** (20°57'N., 92°14'W.) consists of two groups of coral reefs lying 6 miles apart, which lie 53 miles S of Cayo Nuevo. Depths of 49 to 53m exist in the channel between them.

Triangulo Oeste, a reef 0.8 mile long, with a cay 3.4m high on its SW end, has a ledge with depths of 11 to 16.5m extending NE from the cay. Seal Bank, a ledge with a least depth of 12.8m, lies 1.5 miles farther NE.

A disused lighthouse stands near the light on the cay near the SW end of Triangulo Oeste.

A dangerous wreck lies 22 miles NE of the light on Triangulo Oeste.

**Triangulo Este** (20°55'N., 92°13'W.) and **Triangulo Sur** (20°54'N., 92°14'W.), which nearly dry, are separated by a channel 0.2 mile wide, with depths of 10 to 20m. A cay, 7.3m high, stands on the S end of Triangulo Este. A stranded wreck lies on the E edge of Triangulo Sur. A reef extends 1 mile NE from the cay, and a coral ledge extends about 1 mile farther NE. Triangulo Sur has a ledge extending about 1 mile SW from the SW cay of several which stand on it.

An 11m patch was reported (1916) to lie 25 miles NNE of Triangulo Este. A rock, awash, was reported (1921) to lie 7 miles S of this patch. A detached 14.6m patch lies about midway between these two dangers.

**Anchorage.**—Anchorage can be taken, in a depth of 13m, about 1 mile SW of the SW cay on Triangulo Sur.

**7.6** Banco Ciudad Condal, a detached shoal with a depth of 11m, lies 8 miles S of Triangulo Este.

In 1977, a depth of 33m was reported to lie 6 miles SE of Banco Ciudad Condal.

**Obispo Norte** (20°29'N., 92°12'W.) and Obispo Sur, two dangerous shoals with general depths of 7 to 18m, lie 25 miles S of Triangulo Este and are marked by discolored water. A passage, about 1.3 miles wide with a depth of 51m, separates the shoals. Obispo Norte has a depth of 4.5m lying near its N end. A dangerous wreck lies between the two shoals.

**Banco Pera** (20°42'N., 91°56'W.) and Banco Nuevo, two shoal banks with least depths of 16.4m and 14.6m, respectively, lie 28 miles and 38 miles SE, respectively, of Triangulo Oeste.

**Cayos Arcas** (20°13'N., 91°58'W.), the S dangers of Banco de Campeche, are a group of three islets which lie 44 miles SSE of Triangulo Este.

Cayo del Centro, the N and largest, is composed of sand and rises at its S end to a height of 6m. It lies on the SE end of a reef which extends about 1 mile NW and 0.5 mile W from it;

this reef is encumbered by foul ground and is always visible. The islet is scantily-covered with grass. Bushes and several clumps of palms are also present. A pair of lighted range beacons, in line bearing 107°, stand on the cay.

Anchorage can be taken, in depths of 11 to 18m, coral and rock, about 1 mile WNW of the cay on the alignment of the range.

Cayo del Este, a small cay, 3m high, lies on a detached reef lying 0.3 mile SE of Cayo del Centro. The intervening channel has depths of 11 to 25.6m.

Cayo del Oeste, a small 2m high cay, lies on a small detached reef about 0.8 mile W of the S end of Cayo del Centro. The narrow intervening passage has depths of 6.4 to 91m.

**7.7 Cayos Arcas Terminal** (20°10'N., 91°59'W.) (World Port Index No. 9395) lies close SW of the cays within the limits of an Area to be Avoided associated with a marine oil field. Two distribution platforms are situated at the N end of a submarine pipeline carrying oil from the marine oil field, 45 miles S. Operations are conducted 24 hours.

**Depths—Limitations.**—Submarine pipelines are laid from the above platforms to two SPMs within the terminal area. Two moored storage tankers are also in use. For berthing information see the table titled **Cayo Arcos Terminal—Berth Information**.

**Pilotage.**—Pilotage is compulsory. Pilots are available Monday through Saturday from 0800 to 1800 and on Sunday from 0800 to 1200. An ETA should be sent to PEMEX through the agent prior to arrival at the terminal.

A pilot will board inbound vessels 2.5 miles SE of the S SBM or 2.5 miles SW of the platform.

The pilots can be contacted, as follows:

1. VHF: VHF channel 16
2. Telephone: 52-938-382-3687
3. Facsimile: 52-938-382-4420
4. E-mail: [snppdgca@prodigy.net.mx](mailto:snppdgca@prodigy.net.mx)

**Anchorage.**—Vessels can obtain anchorage in the charted anchorage area SE of the terminal.

**Directions.**—On approaching the terminal, masters of inbound tankers should head directly for the anchorage area, where vessels will be boarded by a mooring master.

## Cabo Catoche to Punta Boxcohuo

**7.8 Cabo Catoche** (21°36'N., 87°04'W.), a sand projection on the N point of Isla Holbox, is fringed by depths of 5.5 to 9m which extend 10 miles N and NE.

Cayo Arcos Terminal—Berth Information					
Berth	Depth	Maximum Vessel			Remarks
		Size	Length	Beam	
FPSO Yuum Kak Naab	105m	350,000 dwt	—	—	
SPM No 1	44m	—	350m	—	Crude oil
SPM No 2	44m	275,000 dwt	350m	51m	
Ta'kuntah FSO	75m	350,000 dwt	389m	60m	

The coast from Cabo Catoche extends 85 miles W to Punta Yalkubul, and then 105 miles WSW to Punta Boxcohuo. This section borders the N coast of Peninsula de Yucatan and is low and arid, with few conspicuous landmarks. Many detached shoals and patches fringe this coast. Lagartos Lagoon, a narrow, shallow lagoon, lies parallel to almost all of this section of coast.

Progreso is the only port of any importance. Several small villages lie on the coast.

The 20m curve lies 14 miles N of Cabo Catoche and extends W along the coast 12 to 18 miles offshore to a position 24 miles N of Punta Boxcohuo. The dangers seaward of this curve have been previously described. A shallow coastal bank, as defined by the 5m curve, fronts this coast 1 to 5 miles offshore. Irregular depths lie between the 5 and 20m curves. The dangers within the 20m curve are described under the principal description of the coastal features.

Between Cabo Catoche and Punta Boxcohuo, the current sets W at a rate of 0.5 to 1 knot, following the trend of the coast 30 miles offshore.

The mean rise at springs ranges from 0.4 to 0.7m. The water on the off-lying banks is influenced by the winds, as well as the tides. The effect of the latter may be offset by the wind effect for a period of several days.

**Isla Holbox** (21°33'N., 87°14'W.) is one of a chain of low, narrow islands which front the coast between Cabo Catoche and Boca de Conil to the W. Punta Francisca is the NW extremity of the island. A chain of cays, fronted by numerous sand ridges, with depths of 2.4 to 9.1m, extends 8 miles NE from Cabo Catoche and 9 miles NW from Punta Francisca. Bajo Corsario, with a least depth of 4.6m, lies 8 miles N of Punta Francisca.

**Boca de Conil** (21°29'N., 87°35'W.), 3 miles wide, is the W entrance to Laguna de Yalahua, a shallow body of water lying between Isla Holbox and the mainland. Foul ground extends 7 miles NW from Boca de Conil.

The low sandy coast between Boca de Conil and Cuyo, 16 miles W, is marked by conspicuous groves of trees near its E end.

**Cuyo** (21°32'N., 87°41'W.), a town, is fronted by a wharf, 107m long, with a depth of 2.1m alongside its outer end. It stands on the narrow strip of land between the sea and the lagoon which parallels this coast. El Cuyo, a 12m high hill, stands close to the town. A 3.7m shoal lies 5 miles N of the town.

**7.9 Las Coloradas** (21°37'N., 88°01'W.), fronted by an open roadstead, has two small piers. The principal export is salt, which is barged out to the anchorage. From the N, depths in the approach are 7.3 to 9.1m and are quite regular, with no known dangers in the immediate vicinity. The two piers are reported to be radar conspicuous.

The coast between Cuyo and the Rio Lagartos, 30 miles W, is fronted by a low, sandy beach. The Rio Lagartos is the outlet of the narrow lagoon that parallels this coast.

Alert Patch, existence doubtful, with a least depth of 4.6m, lies 14 miles NW of the Rio Lagartos entrance.

Bajo Antonieta, a shoal which uncovers 0.6m, lies 4 miles WNW of the Rio Lagartos. Between the Rio Lagartos and Punta Yalkubul, 22 miles W, the coast is more elevated, being 52m

higher 6 miles E of the point.

**Punta Yalkubul** (21°32'N., 88°37'W.) is low and marked by trees. Bajo Carmelita, a shoal with depths of less than 4.6m, lies 11 miles NW of the point. Bajo Pawashick, a shoal with a least depth of 2.7m, lies 9 miles W of the point.

The coast between Punta Yalkubul and Punta Arenas, 13 miles SW, remains low. A shallow lagoon entrance lies close E of the latter point.

Dzilam (Silan), a small town fronted by a pier, is situated 6 miles W of Punta Arenas.

Between Punta Arenas and Progreso, 48 miles W, the coast consists of low sandy beach, slightly wooded, and backed by swampy ground. A prominent coastal light is shown 2 miles SE of the village of Telchac. Several additional villages lie along this section of coast.



**Telchac Light**

Chicxulub, a small village fronted by a pier, is situated 2 miles E of Progreso.

**7.10 Progreso** (21°17'N., 89°40'W.) (World Port Index No. 9510) is the most important port on Peninsula de Yucatan.

**Winds—Weather.**—The prevailing winds are from the NE to SE. Northers occur between October and March.

**Tides—Currents.**—The current sets to the W. The tidal range is 0.4m.

Puerto Progreso—Berth Information			
Berth	Length	Draft	Remarks
<b>Remota Terminal</b>			
North Pier	320m	11.5m	Passenger
South Pier	320m	11.5m	Passenger
Ferry Dock	180m	7.0m	Ferries
<b>Multipurpose Terminal</b>			
No. 3	240m	7.9m	Containers and general cargo
No. 4	140m	7.9m	Containers and general cargo



Puerto Progreso—Berth Information			
Berth	Length	Draft	Remarks
<b>Container Terminal</b>			
No. 5	210m	7.9m	Containers
No. 6	288m	11.5m	Containers
No. 7	247m	11.5m	Reported (2013) under construction
<b>Bulk Terminal</b>			
No. 8	188m	11.5m	Grain
<b>Tanker Berths (Oil Terminal)</b>			
Pemex	300m	11.5m	Petroleum products

**Depths—Limitations.**—In the approach to the port from N, vessels will pass through a dredged channel, with a depth of 12.0m, and approximately 150m in width, extending 4 miles N of Terminal Remota.

Muelle Fiscal is on the causeway about 1 mile from shore. It is 204m long and has an alongside depth of 4.9m.

Pino Suarez Pier, close W of the root of the causeway, is lighted and has an alongside depth of 2.7m. For berthing information see the table titled **Puerto Progreso—Berth Information**.

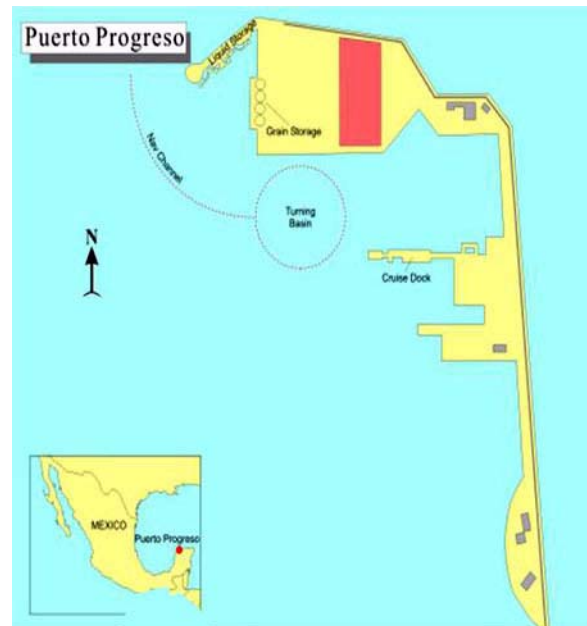

**Terminal Remota at Puerto Progreso**



**Progreso Cruise Ship Pier**

A turning circle, marked by lighted buoys, has been estab-



**Terminal Remota**

lished for vessels approaching the berths at Terminal Remota.

**Aspect.**—A lighted causeway and pier about 3 miles long runs from Terminal Remota to the shore just N of Progreso Light. Terminal Remota is marked by lights, one of which has a racon.

When approaching Progreso, a square tower, 18m high, stands close W of the light. East of the town, and somewhat detached from it, is a large square building close to the coast and

partly surrounded by trees. The town itself appears as a group of low gray or white buildings. The piers, together with the warehouses on them, are prominent.

**Pilotage.**—Pilotage is compulsory for vessels going alongside the pier or shifting anchorage. Vessels should advise their ETA 24 hours prior to arrival. Vessels should confirm ETA 4 hours and 2 hours prior to arrival.

For vessels with a draft of 7m or greater, pilots board approximately 3 miles N of the fairway buoy at the entrance to the dredged channel, about 3.25 miles N of Terminal Remota. Vessels with a draft less than 7m will board the pilot about 2.5 miles NW of Terminal Remota.

Vessels of less than 7m draft may use the close outside W edge of the dredged outer channel to reach the inner pilot boarding area if it is busy. Shallow draft vessels may also use this W edge of the dredged channel when departing.

The pilots can be contacted, as follows:

1. VHF: VHF channel 16
2. Telephone: 5201-969-9350-300
3. Facsimile: 5201-969-9350-009
4. E-mail: [pilotosprogreso@prodogy.net.mx](mailto:pilotosprogreso@prodogy.net.mx)



Progresso—Terminal Remota Pier

**Regulations.**—Vessels should provide an ETA at least 24 hours in advance of arrival.

**Signals.**—Storm signals are displayed from a flagstaff near the light.

**Anchorage.**—General anchorage can be taken about 5.5 miles NNW of the Terminal Remota, in depths of 9 to 15m, by vessels with drafts up to 7.0m. Dangerous cargo anchorage is positioned about 2.5 miles E of the general anchorage. Vessels with drafts of less than 7.0m can anchor 3.0 miles NW of Terminal Remota, in a depth of 6.4m.

**Caution.**—Due to the dumping of construction material, mariners are cautioned to avoid the N side of the Terminal Remota and the E and W sides of the mole, as shown on the chart. A dangerous wreck lies about 1 mile NNW of Progresso Light.

A dangerous wreck, in a depth of 11m, is located in position 21°25.7'N, 89°42.0'W.

**7.11 Puerto de Yukalpeten** (21°17'N., 89°43'W.), 3 miles W of Progresso, is used primarily by fishing vessels and yachts. The E breakwater extends approximately 2.7 miles from the

shore, while the W breakwater is less prominent. The access channel and the berths alongside the two piers are dredged to a least depth of 3m. A power transmission line, with a vertical clearance of 25m, crosses the channel entrance.

The coast between Puerto de Yukalpeten and Sisal, about 20 miles WSW, is marked by several villages and is more wooded than elsewhere in the vicinity. The village of Sisal is now nearly abandoned.

**Arrecife Sisal** (21°21'N., 90°09'W.), a coral reef with an obstruction on it, lies 12 miles NNW of Sisal and may be marked by discolored water under certain weather conditions. A 6.4m coral shoal lies 6.5 miles WNW of Sisal.

The coast between Sisal and Punta Boxcohuo, 17 miles SW, is low and sandy. A building in ruins, 5 miles SW of Sisal, is the only conspicuous landmark.

The coast between Sisal and a position lying 5 miles S of Celestun is radar conspicuous.

## Punta Boxcohuo to Punta Buey

**7.12 Punta Boxcohuo** (21°02'N., 90°18'W.), the NW extremity of Peninsula de Yucatan, is a low, sandy projection. Several shoals are reported to lie near the 10m curve, about 9 miles seaward of the point. A 2.7m shoal lies 3 miles N of the point. A shoal, depth unknown, has been reported to lie 20 miles WNW of the light on the point.

The section of coast forming the W side of Peninsula de Yucatan and the E side of the Bay of Campeche extends 13 miles SSW from Punta Boxcohuo to Celestun, then 60 miles further S to the town of Campeche. A wide and shallow bank fronts this portion of the coast, preventing even light-draft vessels from sighting the shore.

Between Campeche and Punta Morro, 13 miles SW, and Champoton, 20 miles farther S, the coast is bolder and backed by prominent ridges of hills.

Between Champoton and Punta Xicalango, 80 miles SW, the coast is low, wooded, and fronted by a continuous sandy beach. Laguna de Terminos indents the S part of this coast. For a distance of 30 miles SW of Champoton, numerous sand and shell patches, with depths of 4.3 to 9.1m, extend as far as 12 miles offshore.

From Punta Xicalango, the coast extending W for about 45 miles to Punta Buey is low and free of dangers. There are no commercial ports along this section of coast.

**Regulations.**—A mandatory Maritime Traffic Control System serves the Bay of Campeche. The system includes Areas to be Avoided surrounding the marine oil fields and at Cayo Arcas, precautionary areas at track junctions, and specified traffic lanes. These areas are best seen on the chart. Control Centers are located at Cayo Arcas, Dos Bocas, and at four additional platforms, designated IXTOC1, AKAL-C, KU1, and ECO1.

Vessels intending to enter an area should report to a Control Center 1 hour prior to entry with the following information:

1. Vessel name.
2. Port of registry.
3. Vessel number.
4. Name of owner (company).
5. Master's name.
6. Destination.
7. Port of departure.



**Platform Akal-C**

8. Displacement.
9. Draft.
10. Type of cargo.

Within the area, vessels must follow instructions from the Control Center. Permission must be obtained prior to anchoring.

Radar surveillance is maintained between Cayo Arcas and Dos Bocas and in their approaches. Vessels will be guided as needed within the radar surveillance area. Control Centers also serve as information centers for the area.



**Cayo Arcas Platform**

**Caution.**—Offshore oil fields are being extensively developed in the Bay of Campeche. Mobile drilling rigs, platforms, and associated structures, sometimes unlit, sometimes with racons, may be encountered anywhere in the area. Numerous submarine pipelines, many uncharted, exist within the oilfields and between them and the shore.

Most of the platforms are in a specific Area to be Avoided, whose boundaries are best seen on the chart. A storage tanker is moored NNE of the NE boundary of the area.

A directional swell measurement buoy lies about 20 miles W of Punta Morro. An obstruction is located about 3.4 miles NNE of Punta Xicalango and about 1.4 miles NNW of the outer range light buoy.

A major offshore oil field is situated between 40 miles and 58 miles SSW of Cayos Arcas. Several production platforms, interconnected by submarine pipelines, are situated throughout this area. A submarine pipeline extends SW between the central platform (19°24'N., 92°02'W.) and a terminal on the coast at Barra de dos Bocas. Ship movements in the area are controlled by a Maritime Controller on a 24-hour basis. Vessels planning to enter the area should report to the Maritime Controller on VHF channel 16 and comply with the Maritime Controller's directions.



**Faro Sabancuy**

The depths seaward of the 20m curve have been previously described. The depths within this curve, which lies up to 35 miles offshore, are irregular. The coastal bank, as defined by the 5m curve, extends up to 12 miles offshore between Punta Boxcohuo and Champoton, which is described in paragraph 7.15.

**7.13 Bancos de Champoton** (19°23'N., 90°50'W.), a group of detached patches with depths of 4.3 to 8.2m, extends 10 to 15 miles W from Champoton.

**Bancos de Sabuncuy** (19°10'N., 91°16'W.), a group of patches with depths of 4.3 to 9.1m, lies 32 miles SW of Champoton and extends up to 12 miles offshore. An artificial reef lies about 1.5 miles N of Sabuncuy in depths of 5 to 8m.

Between Punta Boxcohuo and Celestun, the coast is low and sandy. Two shoal patches, with depths of 8.2m and 9.1m, lie about 16 miles W of Celestun.

There is seldom any current off the W side of Peninsula de Yucatan.

During the rainy season, from June to September, squalls develop at times with considerable force.

The prevailing winds are from directions between the NE and SE.

**Real de Las Salinas** (20°45'N., 90°26'W.), the W entrance to the lagoon which parallels the N coast of Peninsula de Yucatan, lies 6 miles S of Celestun.

Between Real de Las Salinas and Campeche, 55 miles to the S, the low coast is bordered by swampy ground for about 25 miles and then becomes more elevated, rising to heights of 30 to 85m N of Campeche. Isla de Piedras, 9m high, stands close offshore, 23 miles N of Campeche.

**7.14 Campeche** (19°51'N., 90°33'W.) (World Port Index No. 9500), the capital of the state of Campeche, stands on a plain bordered on three sides by a small amphitheater of hills. Fort San Jose stands on the NE outskirts of the city and Fort San Miguel stands on the SW perimeter of the city. The city serves as the distributing point for the W coast of Peninsula de Yucatan. Sisal is the principal export. Port facilities are located at the town of Lerma, 3.5 miles SW of Campeche.



Campeche

**Depths—Limitations.**—Vessels are restricted to a maximum draft of 10m and must stay in the channel due to sand bars in the port approach. A lighted range, in line bearing 139°, leads into the port. The seaward safe water buoy marking the range has been reported missing (2001).

Muelle Castillo Breton, a pier about 500m long, with a depth of 3.6m alongside, extends from the village of Lerma, 3.5

miles SW of Campeche. The pier has 213m of berthing space at its outer end, 122m of which is reserved for local fishing vessels.

Muelle Fiscal (Muelle Pemex) is 521m long and has a depth of 5.1m alongside.

Muelle Unidad Pesquera has a depth of 4.2m alongside and is used exclusively by fishing vessels.

Puerto de Abrigo is situated 0.3 mile SE of Muelle Castillo Breton; there is a small pier about 0.3 mile NE of the same jetty.

**Pilotage.**—Pilotage is compulsory for vessels berthing alongside.

**Regulations.**—The Marine Traffic Control System is a mandatory system which applies to vessels intending to enter the area bounded by lines joining the following positions:

- a. 20°30'N, 93°30'W.
- b. 20°30'N, 91°25'W.
- c. 18°15'N, 91°25'W.
- d. 18°15'N, 93°30'W.

It has been reported (2013) the control system is not operational.

**Signals.**—A signal station is situated atop Fort San Jose NE of Campeche Light. A blue flag indicates threatening weather while a red flag indicates that the port is closed.

**Anchorage.**—Anchorage can be taken, in a depth of 6.4m, about 11.8 miles W of Campeche. This anchorage is not so subject to the effects of northers as are other gulf ports.

**Caution.**—Vessels approaching the anchorage should note that dangerous wrecks lie 10 miles NW and 18 miles W of Punta Mastun. An artificial reef lies about 2.5 miles E of Lerma in depths of 5 to 8m.

**7.15** Between Campeche and Punta Mastun Grande, a wooded, 129m high headland about 9 miles SW, and Punta Morro, 5 miles farther SSW, the coast is bold and backed by ridges of hills.

Between Punta Morro and the Rio Champoton, 20 miles S, the coast is backed by a ridge of hills that are more broken than those to the N. The ridge terminates in a prominent, 110m high hill about 8 miles S of the river.

**Champoton** (19°22'N., 90°43'W.), a small village, stands on the S side of the entrance to the Rio Champoton. An old fort and two churches stand in the town. Observation Cay, 1.5m high, lies close off the river entrance.

The river is entered passing S of Observation Cay, a rocky islet which lies 0.2 mile off the mouth of the river. There is a depth of 0.9m over the bar and depths of 6 to 7m inside the river.

Between the Rio Champoton and Barra de Puerto Real, 55 miles SW, the low, wooded coast is fronted by a continuous stretch of sandy beach. Numerous sand and shell patches, with depths of 2.4 to 5.5m, lie up to 5 miles off this section of coast.

**Barra de Puerto Real** (18°47'N., 91°30'W.), the E entrance to Laguna de Terminos, is 2 miles wide and has depths of 1.8 to 3.7m. A pair of lighted beacons, in line bearing 151°, stand on Punta del Tigre on the N side of the entrance. A shallow, breaking spit extends 2.5 miles WNW from the point. A channel for vessels with drafts of less than 3m leads to an anchorage off Punta del Tigre, but should not be attempted without local knowledge. A road connects Isla Aguada on the E side of the

entrance with the coast SE of Puerto Real on the W side.



**Faro Isla Aguada**

Isla del Carmen, low and sparsely wooded, fronts Laguna de Terminos between Barra de Puerto Real and Barra Principal, the W entrance of the lagoon, lying 20 miles WSW.



**Ciudad del Carmen from SW**

**7.16 Ciudad del Carmen** (18°39'N., 91°50'W.) (World Port Index No. 9490) consists of numerous jetties and wharves which project from the W shore of the town. There is a dredged

fishing vessel haven to the N of the jetties. A naval base is situated to the S of the harbor.

**Depths—Limitations.**—The Main Quay, 350m long, has an alongside depth of 3.6m and is used mainly by offshore petroleum companies. Muelle Fiscal, 130m in length, has a depth 3.3m. The Navy jetty is 70m in length and an alongside depth of 5.5m.

Barra Principal is 6 miles wide between Punta Vigia, 0.5 mile SE of the SW end of Isla del Carmen, and Punta Xicalango, on the opposite side of the entrance. A breaking spit extends 4.5 miles NW from Punta Vigia and depths of 1.8 to 3.7m extend 3 miles N from Punta Xicalango. A buoyed channel, with depths of 3.7 to 4.3m, leads through these shoals to the town of Ciudad del Carmen, on the SE side of Punta Vigia. A rock bar in the channel limits the size of vessels using the port to a draft of 3.7m.



**Faro Xicalango**

**Aspect.**—Two lighted beacons, in line bearing 180°, stand on the W side of the entrance and indicate the fairway of this channel.

**Pilotage.**—Pilotage is compulsory.

The pilots can be contacted, as follows:

1. VHF: VHF channel 16
2. Telephone: 52-938-382-4868
3. Facsimile: 52-938-382-7453
4. E-mail: [snppdgca@prodigy.net.mx](mailto:snppdgca@prodigy.net.mx)

**Anchorage.**—Good anchorage can be taken, in depths of 7 to 9m, about 8 miles NNW of Punta Vigia. The mud bottom is good holding ground, but this anchorage is not safe during the season of the northers.

Secure anchorage can be taken off the town in depths of 9 to

11.9m, keeping clear of the approach to the wharves. Anchorage is also recommended 6 miles N of Punta Vigia, in a depth of 4.9m.

Between Barra Principal and the Rio Grijalva, 46 miles W, the coast is low and has no prominent features.

**Caution.**—Considerable changes to depths, navigational aids, and the coastline have taken place in the approaches to Ciudad del Carmen. The most recent editions of appropriate charts should be consulted. Shoaling has been reported (2009) close W of the 180° approach route and about 2.8 miles N of Xicalango Range Lights.

A precautionary area is situated about 10 miles N of Ciudad del Carmen. Only petroleum exploration and exploitation activities and transiting fishing vessels are allowed in this area, as seen on the chart.

## Punta Buey to Coatzacoalcos

**7.17 Punta Buey** (18°39'N., 92°43'W.) is a low point which has been reported to be extending N and NW. Depths of 5.5 to 7.3m extend about 1.5 miles N and NW from the point.

The coast recedes 8 miles SW from Punta Buey, then extends in a general WSW direction for a distance of 95 miles to Coatzacoalcos, then W for 10 miles and then NNW for an additional 25 miles to Punta Zapotitlan. This low, marshy coast is indented by several lagoons and is covered with very heavy vegetation, except in the tidal marshes. Several rivers discharge into the gulf, and hills stand 3 to 8 miles inland on the W part of this coast.

The 20m curve lies 7 miles NW of Punta Buey and extends along the coast 2 to 4 miles offshore. With the exception of a shoal, with a least depth of 7.9m, which lies 5 miles NW of the mouth of the Rio Coatzacoalcos, there are no known off-lying dangers.

From October to March, the current near the shore sets E at a rate of 1 to 1.5 knots.

The winds tend to blow from the N. Northers occur at about 8 day intervals between October and March.

**7.18 Frontera** (Alvaro Obregon) (18°35'N., 92°39'W.) (World Port Index No. 9440) stands on the E bank of the Rio Grijalva, 5 miles S of the entrance. The port is used mainly by small coastal vessels.

**Tides—Currents.**—There is only one tidal rise every 24 hours. The tidal rise is 0.6 to 1.2m at springs.

When the river is at its highest level, the bar has the least depth over it; and when it is at its lowest, the channel being contracted, is flushed out and becomes deeper. At the end of the rainy season in December, the least depths may be expected, but the first norther will increase the depth by about 0.9m and again a freshet may reduce it by a similar amount.

**Depths—Limitations.**—Depths of less than 5m extend 0.8 mile N and 1 mile NW from the E entrance point, and similar depths extend 1.5 miles N and 0.5 mile W from Punta Buey. The bar, which lies N of the entrance points, has been reported dredged to a depth of 4.6m. The buoyed channel within the river has a navigable width of about 230m with depths of 3.7 to 4.9m. The preferred channel passes E of Isla Buey, about 3 miles S of the entrance.

Grijalva Canal, which crosses the peninsula S of Punta Bu-

ey, was a former river entrance, but is no longer used.

Fiscal Wharf, which parallels the shore abreast the town, is 300m long and has a depth of 5.5m alongside. Vessels with drafts up to 4.6m have entered the port.

**Pilotage.**—Pilotage is compulsory. Pilots are summoned from the lighthouse for vessels arriving before 2200. At least 1 hour is required for the pilot launch to go from the town to the anchorage off the canal entrance.

**Anchorage.**—Anchorage can be taken, in depths of 7 to 9m, seaward of the bar. On the approach of a norther, vessels should proceed to sea until it has passed.

Anchorage may be obtained off the W entrance to Grijalva canal. Care must be taken to avoid the wrecks in the vicinity.

Anchorage can be taken in the river off the town. Anchorage berths are allocated by the port authorities.

**Caution.**—An overhead cable, with a vertical clearance of 36m, spans the river close N of Frontera.

It has been reported (2009) that recent hurricane activity has reduced the channel depths to 2.7m. It is therefore advisable to exercise caution when navigating this area.

**7.19** Between Punta Buey and Coatzacoalcos, 100 miles WSW, the coast is low, fairly steep-to, and bordered by mangroves and palm trees.

The **Rio Gonzalez** (18°26'N., 93°04'W.), 23 miles SW of Punta Buey, is a shallow river. It can be navigated by light-draft vessels up to 90 miles inland. Barra de Chiltepec, marked by a light, is the E entrance of this river and has the village of Chiltepec on its W entrance point. Small coastal vessels frequent this port, but a local pilot is necessary.

Barra de Dos Bocas, the entrance leading into a lagoon, lies 3.5 miles W of the Rio Gonzalez.

A dangerous wreck lies about 9 miles NE of Barra de Dos Bocas.

**7.20 Dos Bocas Terminal** (18°25'N., 93°08'W.), situated 5 miles W of Chiltepec Light, lies at the SW end of the submarine pipeline extending from the marine oil field.

**Depths—Limitations.**—The terminal has 2,090m of berthing space, with an alongside depth of 7m, and two multi-purpose berths, each 260m long, with a maximum alongside depth of 8.0m. Two SPMs for tankers up to 250,000 dwt are situated in depths of 22m about 11 miles N of the terminal. Submarine pipelines extend S from the mooring buoys to the shore.

**Pilotage.**—Pilotage is compulsory. Pilots are available from 0800 to 1800, Monday to Saturday, and from 0800 to 1200 on Sunday. Vessels should send ETA 72 hours, 48 hours, and 24 hours in advance of arrival. Any change of ETA of more than 12 hours should be reported. Pilots board 2 miles N or NW of the tanker SPM buoys.

**Anchorage.**—An anchorage for vessels waiting to berth is centered in position 18°45.2'N, 93°10.5'W, 7 miles N of the tanker anchorage.

Anchoring is prohibited within an area shown on the chart enclosing the moorings and submarine pipelines.

**7.21 Barra de Tupilco** (18°26'N., 93°25'W.), a shallow entrance leading into a lagoon, lies 16 miles W of Barra de Dos Bocas. A disused tower stands on the E side of the entrance.

Laguna del Carmen, a lagoon, lies 26 miles W of Barra de

Tupilco. A rock, awash, was reported (1976) to lie 17 miles NNW of Laguna del Carmen.

The **Rio Tonala** (18°13'N., 94°08'W.), with depths of 2.4 to 3m on the bar at its entrance, lies 16 miles W of Laguna del Carmen. Each river entrance point is marked by a conspicuous sand hill. A light is shown from the W entrance. Small vessels with drafts up to 2.4m can enter the river, but local knowledge is necessary. Vessels anchor within the above-mentioned rivers to load mahogany.

An SPM is reported to be situated about 3 miles NE of Coatzacoalcos harbor entrance.

### Coatzacoalcos (18°09'N., 94°25'W.)

World Port Index No. 9405

**7.22** Coatzacoalcos, formerly known as Puerto Mexico, stands on the W bank of the Rio Coatzacoalcos, close within the entrance, and is a first port of entry. The free port stands on the same side of the river, S of the town. On the E side of the entrance is a round hill. The town, with its buildings and radio towers, is prominent from seaward. Low land fronts the hills on either side. Approaching from seaward, several high dark

green hills will be observed E of the entrance. Some low sandhills appear W of the entrance, the tops of which are covered with green vegetation. The water is muddy for about 1.5 miles outside the heads of the breakwater. The breakwaters are conspicuous. The E side of the river mouth is radar conspicuous at 40 miles.

**Winds—Weather.**—The port of Coatzacoalcos is occasionally closed, in some cases for 2 or 3 days, during strong northers, which generally occur from November to March. These storms can raise the water level considerably in the port.

**Tides—Currents.**—Strong currents may be encountered in the vicinity of the port.

**Depths—Limitations.**—The maximum allowable draft of vessels crossing the entrance bar is 11.3m. It was reported that the depths over the bar were liable to decrease considerably because of unusually strong currents setting to the W, but more so when the river is flooding, from June to October, when both currents are strong.

The approach channel from the entrance to Darsena de Pajaritos is dredged to a depth of 14m over a width of 100m. The channel leading to the Rio Coatzacoalcos is 200m wide and dredged to a depth of 10m. For berthing information see the table titled **Coatzacoalcos—Berth Information**.

Coatzacoalcos—Berth Information					
Berth	Length	Depth	Maximum Vessel		Remarks
			LOA	Beam	
Mulle de Cabatoge	144m	11.0m	—	—	Coastal trade
No. 1	220m	12.3m	200m	—	General cargo
No. 2	158m	11.6m	200m	—	General cargo
2A/3	210m	10.9m	200m	—	Grain
3A	120m	11.0m	200m	—	Genera cargo
No. 4	126m	11.0m	200m	—	General cargo
No. 5	180m	11.0m	200m	—	Containers
No. 6	250m	11.0m	200m	—	Pemex, liquid, and sulphur
No. 7	290m	11.0m	200m	—	Fertilizer
No. 8	200m	11.0m	—	—	Petrochemicals
No. 9	118m	—	177m	—	Double deckerr ro-ro ferry
Naval Base	200m	—	—	—	Naval vessels and replenishment tankers
Terminal Maritima de Troy Industries					
East side	232m	10.3m	—	—	Sulfuric acids
West side	252m	10.3m	—	—	Phosphoric rock
Terminal Maritima de Argonitrogenados					
East side	340m	10.9m	—	—	Break bulk
West side	340m	10.9m	—	—	Liquid cargo
Pemex Pajaritos					
No. 1 East	235m	10.6m	—	30m	LPG
No. 1 West	235m	12.4m	—	30m	LPG
No. 2 East	280m	13.5m	—	36m	LPG and chemicals

Coatzacoalcos—Berth Information					
Berth	Length	Depth	Maximum Vessel		Remarks
			LOA	Beam	
No. 2 West	280m	13.5m	—	36m	LPG and chemicals
No. 3 East	300m	12.8m	—	37m	LPG and crude
No. 3 West	300m	13.5m	—	42m	LPG and crude
No. 4 East	300m	13.5m	—	42m	Petroleum products
No. 4 West	300m	13.5m	—	42m	Petroleum products
No. 5	220m	14.0m	—	42m	Petroleum products
No. 6	250m	13.5m	—	42m	Petroleum products
No. 7 East	370	14.0m	—	42m	Petroleum products
No. 7 West	370m	14.0m	—	42m	Petroleum products
No. 9 East	370m	—	—	42m	
No. 9 West	370m	—	—	42m	

**Pilotage.**—Pilotage is compulsory. Vessels should send an ETA 24 hours prior to arrival. The pilot will meet the vessel 2 miles N of the breakwater; during foul weather the pilot will meet the vessel inside the breakwater.

Pilotage for vessels up to 220m in length is available 24 hours. Pilotage for vessels over 220m in length is available only from 0600 to 1700.



Coatzacoalcos Entrance Light on the breakwater

The pilots can be contacted, as follows:

1. Call sign: Practicos Coatzacoalcos
2. VHF: VHF channels 10, 11, 14, and 16
3. Telephone: 5201-921-2120-094
4. Facsimile: 5201-921-2130-697

**Caution.**—Because of the strong currents, all vessels of 2,500 grt or greater are required to employ a tug for berthing, undocking, or maneuvering within the limits of the harbor.

**7.23 Pajaritos** (18°09'N., 94°25'W.) consists of the Pemex Wharves, which are composed of seven concrete finger piers, with a berth on either side. These piers are situated within the SW part of Darsena de Pajaritos.

**Tides—Currents.**—Offshore, the current sets NW, but near

the breakwaters it sets E. The current in the river varies with the stage of the tide, attaining its maximum rate of 5 to 5.5 knots about 2 hours after HW. During the first 3 hours of the flood, the rate ranges from 2.5 to 3 knots. The rise of the tide is about 0.6m.

**Depths—Limitations.**—In the approach to the port, depths of 16m are encountered within 1 mile N of the breakwater heads. They shoal gradually to general depths of 9 to 10.4m, between the breakwaters and the navigable channel within the river.

The channel leading to the existing berths and the turning basin is dredged to a depth of 14m at MLW.

In the E part of Darsena de Pajaritos there is a quay, 425m long. Vessels up to 35,000 grt and 10m draft can be accommodated.

**Pilotage.**—Pilotage is compulsory. The pilot boat will meet vessels 0.5 to 3 miles off the breakwater. A vessel should not approach the breakwaters too closely, due to the strong currents which set across the entrance.

Pilotage for vessels up to 220m long is available 24 hours. Pilotage for vessels over 220m long is available only from 0600 to 1700.

An ETA should be sent soon after departure from the last port of call but at least 24 hours before arrival. The Coatzacoalcos pilots provide pilotage for Pajaritos.

**Anchorage.**—The anchorage areas in the vicinity of the port may best be seen on the chart. It was reported that the holding ground in the anchorages was poor and during a N wind most vessels dragged their anchors.

Two anchorage areas, designated E and W, have been established for vessels both entering and sailing from Coatzacoalcos and Pajaritos, and for vessels operating at the SPM buoy.

**Directions.**—The landfall should be made E of the river entrance because the current usually sets to the W or NW. At times, an E current has been observed near the breakwater heads. By day, the town can be identified by the smoke over it, and at night by the glare of the lights. Having sighted the lights on the heads of the breakwaters, a vessel should steer for a po-



sition about 1.5 miles NNW of the breakwaters. From this position, the lighted range beacons should be brought to bear  $162^\circ$ , which leads through the entrance channel. Care should be taken to strictly adhere to this alignment because the depths shoal in places a short distance from it. The edges of the channel are defined by range beacons. When abeam of the ferry landing on the E bank of the river, course may be altered as required for the desired berth.

**7.24** Nanchital, Concepcion, and Minatitlan, all oil-loading facilities, lie upriver from Coatzacoalcos. A bridge spans the Rio Coatzacoalcos about 2.8 miles from the entrance. It has a central lifting span which is opened for traffic at 1100 daily for about 1 hour.

**Nanchital** ( $18^\circ04'N.$ ,  $94^\circ25'W.$ ) (World Port Index No. 9410) is situated 6.5 miles above the river entrance, on the E bank of the Rio Coatzacoalcos. The river channel is available for vessels with drafts up to 8.2m. The port has two T-headed piers, with depths of 8 to 9m alongside and a marginal quay, 239m long, with a depth of 8m alongside. A tug usually accompanies vessels proceeding to Nanchital as far as the Coatzacoalcos Bridge.

The maximum vertical clearance is 29.9m due to the height of the bridge. Vessels are able to turn a little beyond this port, where the river is about 140m wide and has a dredged depth of 10.7m. Vessels up to 177m in length and 8.4m draft can be handled.

**Concepcion** ( $17^\circ37'N.$ ,  $92^\circ49'W.$ ), a similar oil-loading facility, stands on the Rio Uspanapa, 24 miles above its junction with the Rio Coatzacoalcos, which is 3 miles above Nanchital. Vessels up to 91.4m in length and 4.7m draft can be accommodated.

**Minatitlan** ( $18^\circ00'N.$ ,  $94^\circ32'W.$ ) (World Port Index No. 9420), 14 miles above Nanchital, is the site of an oil refinery.

**Depths—Limitations.**—There are several T-head piers available. There is a turning basin, 850m long and 190m wide, which has depths of 7 to 11m.

Vessels proceeding to Minatitlan unload at Nanchital until their draft is reduced to 6.4m, then proceed to Minatitlan to discharge the remainder of their cargo; the reverse procedure is used when loading and outbound.

Vessels up to 145m in length and 6.4m draft can be handled.

**Pilotage.**—Pilotage is compulsory. The pilot boards off the entrance to Coatzacoalcos.

## Coatzacoalcos to Puerto Veracruz

**7.25** Between Coatzacoalcos and the Rio Barilla, about 12 miles W, the coast is low and unvaried.

The Rio Barilla is the entrance of a lagoon which is connected to Coatzacoalcos by a river S of the city.

**Punta San Juan** ( $18^\circ17'N.$ ,  $94^\circ37'W.$ ), 5 miles N of the Rio Barilla, has a small islet lying close off it.

Between Punta San Juan and Punta Zapotitlan, 20 miles NNW, the coast is backed by mountain ranges rising 3 to 8 miles inland. Cerro San Martin, conspicuous from seaward, stands 8 miles inland W of Punta San Juan.

**Punta Zapotitlan** ( $18^\circ33'N.$ ,  $94^\circ48'W.$ ), marked by a light, is a prominent point bordered by a reef which extends 0.5 mile offshore. A 21.9m shoal patch was reported (1950) to lie about

13 miles NNE of the point.

An old disused lighthouse stands near the light structure on the point.



**Punta Zapotitlan Light**

The coast between Punta Zapotitlan and Cabo Rojo extends in a general NW direction for 230 miles. Mountain ranges, with some conspicuous peaks, back the coastal plain. The more prominent coastal features and dangers are lighted. Numerous islets, shoals, and other dangers lie off this section of coast.

**7.26 Arrecife Santiaguillo** ( $19^\circ09'N.$ ,  $95^\circ48'W.$ ), 2m high, lies 11 miles ENE of Punta Coyal, at the NE end of a group of reefs. The reef is marked by a light with a racon.

Arrecife Anegadilla, the outermost reef of the group lying off Punta Coyal, is located 0.5 mile ESE of Arrecife Santiaguillo.

**Arrecife Anegada de Afuera** ( $19^\circ09'N.$ ,  $95^\circ51'W.$ ), 2.5 miles long, lies about 1.5 miles WNW of Arrecife Santiaguillo. A small reef with a cay, Isla Topatillo, on it close, off its S end, is located on Arrecife Anegada de Afuera.

Arrecife Cabeza, 3.5 miles long and 1.5 miles wide, lies 4 miles SSW of Arrecife Santiaguillo. Lights are shown from the NW and SE extremities of the reef. The passages E and W of this reef have depths of 29 to 36.6m.

Arrecife de Enmedio, with shoal patches close off its W side and a small reef and another patch close off its N end, lies 3.5 miles NE of Punta Coyal. A small cay, marked by a light, lies on the S end of the reef.

Arrecife Rizo, 1.5 miles long, lies 1.5 miles SSE of Arrecife de Enmedio. A spit, with a depth of 2m over its outer end, extends a little more than 0.5 mile N from the N extremity of Arrecife Rizo. A light marks the SE extremity of the reef.

**Arrecife Chopas** ( $19^\circ05'N.$ ,  $95^\circ58'W.$ ), 3.3 miles long, lies 2 miles N of Punta Coyal. A small reef lies close S Isla Salmedina, a grass-covered cay, on the S end of the reef. Several small reefs lie close off the N and NW ends.

Arrecife Blanca, 0.3 mile in extent with a small cay on it, lies 1 mile W of Arrecife Chopas.

Vessels without local knowledge should not attempt the passages between Arrecife Rizo, Arrecife de Enmedio, and Arrecife Chopas. Foul ground lies in the passage between Arrecife Chopas and Arrecife Blanca. This passage should not be used.

**Caution.**—An Area to be Avoided, the limits of which may best be seen on the chart, has been established around the reefs in order to protect the National Marine Park, including the Reef System of Veracruz, from the risk of pollution. All vessels greater than 500 grt and all vessels carrying oil, chemicals, toxic cargo, or nuclear cargo should avoid this area.

The group of reefs which lie in the approach to Puerto Veracruz are described under the principal description of that port in paragraph 7.32.

**7.27 Bajo Blake** (20°45'N., 96°58'W.), a shoal with a depth of 9m, lies 13 miles SE of Punta de Piedras.

An obstruction was reported (1923) to lie about 13 miles ENE of Punta de Piedras. A depth of 7m was reported (1967) to lie the same distance ESE of the same point. The existence of the 8.9m shoal reported to lie 18 miles NE of Punta de Piedras is doubtful. A depth of 7.5m lies 3.3 miles NNW of Bajo Blake.

**Arrecife Tuxpan** (21°01'N., 97°12'W.), a small steep-to reef with a low cay on it, lies 6 miles ENE of the Rio de Tuxpan. A light, with a racon, is shown on the S side of the reef.

Arrecife Enmedio, a small reef, lies 3 miles NW of Arrecife Tuxpan.

Arrecife Tanguijo, a small steep-to drying reef, lies 7 miles NW of Arrecife Tuxpan. A light is shown from the NW part of the reef. The passages between the above reefs are clear of any known dangers.

**Caution.**—A submerged wreck lies about 5.7 miles E of the Tuxpan breakwater and about 2.4 miles S of Arrecife Tuxpan Bajo Centro light.

**Isla Lobos** (21°28'N., 97°13'W.), a small islet 9m high, lies 9 miles SE of Cabo Rojo. A reef extends 1 mile N from it. A light, with a racon, is shown from the SW tip of the island.

Arrecife Medio, a small steep-to reef marked by a light, lies 3 miles NW of Isla Lobos Light.

Arrecife Blanquilla, a breaking reef with a drying sandbank on it, lies 6 miles NW of Isla Lobos. A light stands on the reef.

The passages between the above reefs have depths of 17.4 to 51m, but the passage between Arrecife Blanquilla and the coast near **Cabo Rojo** (21°33'N., 97°20'W.) is of doubtful safety, as the soundings are irregular.

The currents off this coast are variable, uncertain, and usually dependent on the force and direction of the wind.

The coastal current usually sets S in the winter and N in the summer.

The trade winds blow from NE to ESE. After the season of the northers, from October to March, there are light N breezes, calms, squally rains, and intermittent thick weather up to the middle of August, when the trades resume again.

**7.28** Between Punta Zapotitlan and Alvarado, 56 miles WNW, the first 33 miles of coast is backed by ranges of hills rising 3 to 8 miles inland. The remaining part of the coast is lower, being composed of sand hills 15 to 61m high.

Barra Sontecomapan, a bar with a depth of 1.8m, obstructs the entrance of Laguna Sontecomapan, 10 miles W of Punta Zapotitlan. The entrance may be identified by a conspicuous umbrella-shaped tree which stands on a bluff a little to the W of it.

Punta El Barco, a bold, rounded bluff, rises 15 miles WNW

of Punta Zapotitlan.

**Punta Roca Partida** (18°42'N., 95°11'W.), marked by a light, consists of perpendicular cliffs located 8 miles WNW of Punta El Barco. A rocky islet lies close off the point.

**Volcan San Martin** (18°33'N., 95°12'W.), 10 miles S of Punta Roca Partida, is a 1,650m high volcano, which can be readily distinguished from a great distance in clear weather. When active, the column of smoke by day and the flames at night make this volcano an excellent landmark.

**7.29 Alvarado** (18°47'N., 95°46'W.), primarily a fishing port, lies within the entrance of a lagoon of the same name lying 32 miles WNW of Punta Roca Partida.

**Depths—Limitations.**—A shoal, with a least depth of 4.2m, lies 1.7 miles N of the E entrance point. Two patches, with depths of 2.4m and 2.1m, lie in mid-channel, about 0.3 mile NW and 0.8 mile SSW, respectively, of the E entrance point.

The bar is located about 0.5 mile outside the entrance points; it is constantly shifting and the sea nearly always breaks on it.

The river is navigable by vessels having drafts less than 3m for a distance of 24 miles upriver.

In 1985, a depth of 8m was reported over the bar.

**Aspect.**—A conspicuous sandy bluff and a beacon stand on the E entrance point. A beacon stands on the W entrance point.

**Pilotage.**—Pilotage is compulsory.

**Anchorage.**—Anchorage can be taken, in depths of 18 to 22m, about 2.5 miles seaward of the bar, but it is not safe during the winter or in the season of the northers. Anchorage can also be taken, in depths of 5.5 to 11m, off Alvarado.

**7.30** The coast between Alvarado and Punta Coyol, 20 miles NW, is bordered by two large lagoons along its S half and by low land along its NW half.

**Punta Coyol** (19°03'N., 95°58'W.) is a blunt point composed of low sand hills. An 80m high sand hill rises 3 miles W of the point. The village of Anton Lizardo stands on the N side of the point.

Arrecife El Giote extends 0.8 mile from the coast close W of Anton Lizardo.

**Anton Lizardo Anchorage** (19°04'N., 95°59'W.), lying between Arrecife Chopas and Punta Coyol, has depths of 12.8 to 20m, sand and mud, and provides protection from the northers. The reefs NE of Punta Coyol have been previously described in paragraph 7.26.

**Directions.**—During the winter months, there is frequently a haze which obscures the land until near the reefs. Under such conditions, it is safer to make the land to the W, where it is bold and clear of dangers, and proceed to the anchorage through the W channel.

Under ordinary conditions, the reefs are marked and there is no difficulty in entering from either the E or W. A vessel having sighted Arrecife Santiaguillo Light, if approaching from the NE, should steer to pass about 2 miles E of it; after having passed E and S of Arrecife Cabeza, a course should then be steered to pass about 0.8 mile S of Arrecife Rizo Light. When Isla Blanca Light bears 299°, it should be steered for on that bearing and anchorage taken as convenient. Care should be taken to avoid the 10.4m patch about 1.5 miles S of Arrecife Cabeza and the 9.8m patch lying 1.8 miles SSE of Isleta Salmedina.



**San Juan de Ulua in Puerto Veracruz Harbor**

A vessel approaching from the N should steer to pass at least 1 mile E of Arrecife Anegada de la Adentro and round Isla Blanca at a distance of 0.5 mile. When Arrecife Rizo Light bears  $107^\circ$ , it should be steered for on that bearing and anchorage taken as convenient.

**7.31** Between Punta Coyol and Punta Mocambo, 9 miles NW, the coast recedes 2 miles to form a sandy bay bordered by low sand hills. A reef lies about 0.8 mile SE of Punta Mocambo. The Rio Jamapa, with depths of 0.9 to 1.8m over the bar, discharges into the gulf 2.5 miles S of Punta Mocambo.

The coast between Punta Mocambo and Puerto Veracruz, 4 miles NW, is low and sandy.

**Arrecife Anegada de Adentro** ( $19^\circ 14'N.$ ,  $96^\circ 04'W.$ ), the outermost reef, is 1 mile long, 0.3 mile wide, and lies 4 miles ENE of the harbor entrance. Two shoal patches, with depths of 7.8 to 9.6m, lie within about 0.3 mile of the SW edge of the reef.

It was reported (1994) that a conspicuous wreck lies on the S end of the reef. Another wreck is reported to lie about 0.6 mile NW of the conspicuous wreck.

Isla Verde, a low white cay marked by a light, stands on the S end of a reef lying 1.5 miles SSW of Arrecife Anegada de Adentro. The intervening channel is about 1 mile wide and has depths of 25 to 36m.

**Bajo Paducah** ( $19^\circ 12'N.$ ,  $96^\circ 05'W.$ ), a shoal with a least depth of 8.9m, lies about 0.3 mile W of the N end of the reef on which Isla Verde lies.

Arrecife de Pajaros, 1 mile long, lies 1.3 mile WSW of Isla Verde. A light is displayed from the NW tip of the reef. The intervening channel has depths of 20 to 29m.

Isla de Sacrificios, a small cay, lies on the S end of a reef close S of Arrecife de Pajaros. A light, with a racon, is shown from the island. The passage between Isla de Sacrificios and Arrecife de Pajaros is narrow and foul.

**Bajo Mersey** ( $19^\circ 11'N.$ ,  $96^\circ 06'W.$ ), with a least depth of 4.5m, lies 0.8 mile NW of Isla de Sacrificios. Shoals with a least depth of a little over 6m, extend up to about 0.3 mile NW from Bajo Mersey.

Arrecife Blanquilla, 0.5 mile in extent, lies 1.8 miles W of Arrecife Anegada de Adentro. Two shoal patches, with depths

of 15m and 16m, lie about 0.8 mile WNW and 1 mile NW, respectively, of Arrecife Blanquilla. A 9.7m shoal patch lies 0.5 mile E of the root of the NE breakwater. The channel between Arrecife Blanquilla and Arrecife Anegada de Adentro is 1.5 miles wide and has depths of 16 to 40m. The channel W of Arrecife Blanquilla is about 0.8 mile wide and has depths of 18 to 31m.

Arrecife La Gallega extends 1.3 miles N from the N side of the harbor. Arrecife Galleguilla, marked by a light, lies close NE of its N end.

Arrecife Hornos extends about 0.3 mile E from the root of SE breakwater.

### **Puerto Veracruz ( $19^\circ 12'N.$ , $96^\circ 08'W.$ )**

World Port Index No. 9380

**7.32** Puerto Veracruz, one of the principal ports of Mexico and a port of entry, is an artificial harbor protected on three sides by breakwaters. Ample berthing facilities are provided for all classes of vessels.

**Winds—Weather.**—With the exception of the land breezes at night, the winds usually blow from seaward and are heavily saturated with moisture causing a high humidity rate. March and April are the least humid months.

Offshore, the trade winds blow from NE to the ESE. During the season of the northers, from October to March, winds up to 50 knots occur, making it impossible for vessels to enter the harbor. After April, there are light N winds, calms, squalls, and unsettled weather until about the middle of August, when the trades again resume.

Land and sea breezes regularly alternate, even in the intervals between the northers. The former begins shortly after sunset; the latter begins about 0900.

**Tides—Currents.**—The diurnal range of the tide is 0.5m. The water level is appreciably influenced by the force and direction of the wind.

The tidal currents are weak and are overcome by the coastal currents which are also affected by the winds. During the winter, the current usually sets S and in the opposite direction during the summer.



Puerto Veracruz—NE inner entrance



Puerto Veracruz

**Depths—Limitations.**—In normal weather conditions, there are no restrictions on entry or departure. The sole consideration is the draft of the vessel since, if the draft exceeds 8.8m, the time of the tide must be considered; after a strong N wind, a vessel with a draft of more than 7.3m must wait for the tide. The access channel has depths of 10 to 12m.

In the basin formed by the above reefs, the depths range from 18 to 40m. The 20m curve lies 0.8 mile off the harbor entrance, with the depths shoaling gradually to a depth of 10.5m between the breakwater heads. Considerable silting has taken place within the harbor and only vessels with a maximum draft of 9m are able to enter.

Additional berths with shallower depths are available for small coastal vessels and fishing craft. It has been reported that works are in progress to build an extension to the port in Bahia Vergara, increasing the number of berths.

**Aspect.**—Volcan Citaletpet (Pico de Orizaba), 5,303m high, rises 63 miles W of the city. This inactive volcano has a crater 3.5 miles in circumference, which can easily be distinguished from a considerable distance on a clear day.

Cerro Nauhcampatepetl, 4,280m high, is located 25 miles NNE of the above volcano and has a peculiar shape. Snow falls on isolated spots at elevations of 3,650m or greater.

A prominent high radio tower stands 0.8 mile S of the root of the SE breakwater.

The steep-to reefs in the approach to Puerto Veracruz break and are easily identified in clear weather from aloft. For berthing refer to the **Veracruz—Berth Information** table.

Veracruz—Berth Information			
Berth	Length	Draft	Remarks
Fiscal Pier 1N	218m	9.4m	General and bulk cargo
Fiscal Pier 1S	218m	9.4m	General and bulk cargo
Fiscal Pier 2N	200m	9.7m	General and bulk cargo
Fiscal Pier 2E	67m	10.6m	General and bulk cargo
Fiscal Pier 2S	200m	10.6m	General and bulk cargo
Fiscal Pier 4S	381m	10.3m	General and bulk cargo
Fiscal Pier 4E	100m	—	General and bulk cargo
Fiscal Pier 4N	315m	9.7m	General and bulk cargo
Fiscal Pier 5N	260m	11.2m	General and bulk cargo
Fiscal Pier 5S	260m	10.6 m	General and bulk cargo
Fiscal Pier 6N	260m	10.6m	General and bulk cargo
Fiscal Pier 6S	301m	—	General and bulk cargo
TUM Pier 7S	243m	11.2m	General and bulk cargo
TUM Pier 7E	200m	10.9m	General and bulk cargo
Cement Pier	277m	10.9m	General and bulk cargo
Fiscal Pier 8E	200m	11.5m	General and bulk cargo
Fiscal Pier 8W	200m	11.5m	General and bulk cargo
Container Pier N/S	507m	12.8m	General and bulk cargo

Veracruz—Berth Information			
Berth	Length	Draft	Remarks
T-Pier	200m	8.4m	General and bulk cargo
Pemex E/W	374m	9.4m	General and bulk cargo



Volcan Citaletpet (Pico de Orizaba)

**Pilotage.**—Pilotage is compulsory for vessels over 500 gt, and is available 24 hours. Vessels should send their ETA 24 hours in advance, via the agent, stating vessel name, flag, and draft. Pilotage should be ordered through the agent at least 2 hours in advance. It is reported (2009) that the pilot boards in the vicinity of the fairway lighted buoy close SSE of Isla Verda near position 19°11'25"N, 96°03'28"W or further seaward upon request. Anchoring within the harbor must be done under the supervision of a pilot. Tugs are available and their use is compulsory for berthing and unberthing.

The pilots can be contacted, as follows:

1. VHF: VHF channels 13, 14, and 16
2. Telephone: 52-229-932-2093
3. Facsimile: 52-229-931-4699
4. E-mail: [pilotver@infosel.net.mx](mailto:pilotver@infosel.net.mx)

**Regulations.**—A Traffic Separation Scheme (TSS) has been established in the approaches to Veracruz. In normal weather, there are no restrictions on entry or departure, the sole consideration being the draft of the vessel. If the vessel has a draft of more than 8.8m, the tide must be taken into consideration. After a strong N wind, a vessel with a draft of more than 7.3m must wait for the tide.

Anchoring in the main channel or the harbor entrance is prohibited. All ship movements within the harbor require permission from the captain of the port. Vessels must give advance notice if wishing to enter the harbor at night.

Vessels over 2,500 grt require a tug for maneuvering within the harbor.

**Anchorage.**—Vessels anchor in a designated area, the limits of which may best be seen on the chart, situated ESE of Veracruz.

**Directions.**—To enter the harbor, the cathedral dome about 0.4 mile WSW of Benito Juarez tower should be steered for on a heading of 261°; at night, the light on the head of Muro de Pescadores bearing 270, until the light on the E corner of

Muelle de La Terminal bears 290°, leads through the entrance in mid-channel between the breakwater heads. A course can then be steered for the anchorage.

### Puerto Veracruz to the Rio Tuxpan

**7.33** Between Arrecife La Gallega, which extends N from Puerto Veracruz, and Punta Gorda, 3 miles NW, the coast recedes 2 miles forming Bahia de Veracruz.

From Punta Gorda, the coast extends 6.8 miles WNW to Punta Antigua, on the S side of the entrance to the Rio de La Antigua, and then 9.5 miles to Punta Zempoala. Punta Antigua has been reported to be radar conspicuous.

Bajo Zempoala, with depths of 4.9 to 7.9m, lies 4 miles N of Punta Zempoala and 2 miles offshore.

Between Punta Zempoala and Punta del Morro, 25 miles NNW, the coast has several reef-fringed points and is marked by several conspicuous peaks.

**Pico Zempoala** (19°33'N., 96°27'W.), the S peak, is 701m high and stands about 10 miles NW of Punta Zempoala. Los Dos Antriscos, a peak 799m high, rises 5 miles SW of Punta del Morro. A bare chimney rock, 267m high and prominent, is located 2 miles WNW of Punta Penon, which lies 9 miles NNW of Punta Zempoala.

**Isla Bernal Chico** (19°40'N., 96°23'W.), 44m high, lies close offshore, 12 miles NNW of Punta Zempoala. A prominent bare rocky hill, over 90m high, stands on the coast 1.8 miles WSW of this island.

The coast between Punta Gorda and the Rio Nautla, 30 miles NW, and the Rio Tecolutla lying 18 miles farther NW, is fronted by a narrow thickly-wooded strip of land paralleled by a narrow lagoon. A range of hills rises 5 miles inland.

**Dos Hermanos** (20°06'N., 96°52'W.), a conspicuous peak, rises to an elevation of 357m about 9 miles SSW of the Rio Nautla. Cerro Burras stands about 9 miles SW of the Rio Tecolutla. A dangerous wreck lies 4 miles E of the N side of the mouth of the Rio Tecolutla.

Between the Rio Tecolutla and Punta de Piedras, a reef-fringed point located 25 miles NW, several rivers discharge into the gulf from the lagoon which backs the coast.

Between Punta de Piedras and the Rio Tuxpan, 9 miles NW, the coast is 30m high.

**7.34** The **Rio Tuxpan** (20°58'N., 97°19'W.) has a maximum depth of 4.9m over the bar and is fronted by breakwaters which extend 0.3 mile offshore from the entrance points. Within the bar, the depths increase considerably. The least depth, as far as the town of Tuxpan, is 2.7m. Vessels with drafts up to 2.1m can proceed as far as 36 miles above the entrance.

**Depths—Limitations.**—Situating 5 miles above the entrance to the river, Tuxpan has a Fiscal Wharf, and two additional wharves. For Berthing Information refer to the **Rio Tuxpan—Berth Information**.

**Aspect.**—Several tall stacks and oil tanks standing on the banks of the river are conspicuous from seaward.

**Pilotage.**—Pilotage is compulsory; the pilot boards 2 to 2.5 miles from the harbor entrance. Vessels should send an ETA at least 24 hours in advance.

Movements into and out of the port are restricted to daylight hours. Vessels up to a maximum length of 190m can be handled.

The pilots can be contacted, as follows:

1. Call sign: Tuxpan Pilot
1. VHF: VHF channels 13 and 16
2. Telephone: 52-783-837-0559  
52-783-837-0437
3. Facsimile: 52-783-837-0558
4. E-mail: [pilotstuxpan@prodigy.net.mx](mailto:pilotstuxpan@prodigy.net.mx)  
[pilotstuxpan@hotmail.com](mailto:pilotstuxpan@hotmail.com)

**Anchorage.**—The anchorage area for vessels awaiting berths is centered about 4 miles E of Rio Tuxpan North Light.

Anchorage can be taken off the river entrance, in a depth of 13m, mud, with the lighthouse bearing 234° keeping well clear of the charted anchorage prohibited area. The currents are strong and unpredictable off the river entrance.

**Directions.**—Vessels from the S can approach the coast to within 5 miles and sight the previously-mentioned landmarks.

A vessel approaching from the N should pass E and S of Bajo de Tuxpan and approach with Tuxpan Light bearing 257°. Bajo de Tuxpan is clearly visible by day in clear weather. In hazy visibility, when the lights are visible, a vessel should keep in depths of 27m or greater, anchor, and then await clear weather.

**Caution.**—The navigational lights at the river entrance are hard to identify and may often be confused with the numerous lights of fishing vessels found in the vicinity.

## The Rio Tuxpan to Tampico

**7.35** Between the Rio Tuxpan and Cabo Rojo, the low coast extends NW for a distance of 19 miles, then NNE an additional 18 miles, forming a bight called Puerto Lobos. This bight provides some protection from the northers which blow with considerable strength during the winter. A vessel with local knowledge can ride out the gale by using both anchors.

**Cabo Rojo** (21°33'N., 97°20'W.), a blunt headland composed of sand hills, 11m high, is bordered by a reef which extends 1.8 miles E from it. There are general depths of 18 to 46m lying about 4 to 5 miles offshore.

The coast extends NW for a distance of 49 miles from Cabo Rojo to the Rio Panuco, then 160 miles N and an additional 67 miles NNE to the Rio Grande. In general, the coast is composed of sand dunes and wooded hummocks. Mountain ranges with conspicuous peaks lie farther inland along the S part of this coast. Several extensive lagoons, separated from the coast by narrow strips of land, lie along this section and through it several rivers discharge into the gulf.

Tampico, a major oil port, lies within the entrance of the Rio Panuco.

The 20m curve lies 4 miles E of Cabo Rojo and follows the coast 2 to 5 miles offshore to a position lying 9 miles E of the Rio Grande.

With the following exceptions, all of the dangers lie within the 20m curve and are described under the principal description of the coastal features:

1. An obstruction reported (1921) to exist about 32 miles E of the mouth of the Rio Panuco
2. A shoal, with a depth of 10m, lying 25 miles E of the entrance to Tampico harbor.
3. An isolated 2.5m shoal lying 5 miles SSE of the entrance to Tampico harbor.

During the winter, the current sets N; they set in the opposite direction during the summer. About 15 to 20 miles offshore, the current generally sets N at a rate of 1 knot. The winds are ESE from August to April and E from April to June. During the summer, the land breezes blow from midnight to 0900 and then yield to the sea breezes as far N as 26°N, where the mountain ranges terminate.

Between Cabo Rojo and the Rio Panuco, 49 miles NW, the coast is bordered by a narrow strip of land, 100m to 5 miles wide, fronting Laguna de Tamiahua. Canal del Chijol crosses this lagoon and is frequented by small craft going from Tuxpan to Tampico. The sand hills backing the coast 4 miles N of Cabo Rojo are 21m high and rise to heights of 106m about 18 miles farther N. The coast then becomes very low as far N as the Rio Panuco.

Rio Tuxpan—Berth Information			
Berth	Length	Depth	Remarks
Fiscal Wharf	60m	4.9m	Petroleum products.
Container	300m	11.0m	
Tanker Berths			
Exxon Mobil	80m	5.5m	Chemicals and lubricants.
Mulle de Pemex	90m	6.6m	Bulk liquid.
Offshore Tanker Berths			
North Berth	—	12.1m	Petroleum. Located 2.0 miles offshore. Vessels moors to five buoys.
South Berth	—	10.9m	Petroleum. Located 1.5 miles offshore. Vessels moors to four buoys.
Deep Sea Buoy	—	18.2m	One SBM located in position 21°01'.18"N, 97°15'45"W. Two submarine pipelines used for loading.

**Tampico (22°13'N., 97°52'W.)**

World Port Index No. 9360

**7.36** Tampico consists of the lower reaches of the Rio Panuco, from a position lying 1 mile E of the breakwater heads, for a distance of 15 miles to a position lying 9 miles above Ciudad de Tampico. This city stands on the N bank of the river about 5 miles above the entrance. The port, an important center of the petroleum industry, has a considerable commercial trade. Ample berthing facilities are available to handle all classes of vessels alongside the river wharves.

**Tampico Home Page**<http://www.puertodetampico.com.mx>

**Winds—Weather.**—Hot SW winds blow in the months of March and April and usually begin about 1100 and sometimes last until 1500 or 1600, and then back to the ESE.

Northers are frequent during the winter season and usually last 8 to 24 hours. At such times the port is closed.

**Tides—Currents.**—The tides are irregular and in the vicinity of the bar are greatly affected by the prevailing winds and the rate of discharge from the Rio Panuco. The maximum rise above MLW is about 0.6m.

The general current in the Gulf of Mexico begins to be felt between S and SE about 1.5 miles offshore.

The Rio Panuco current, when the river is in flood, attains a velocity of 8.5 knots between the sea walls and a velocity of 6 knots in the upper reaches. Normally, the current in the river flows at a rate of 3 knots.

**Depths—Limitations.**—The depths in the approaches are

subject to frequent changes and vessels should not enter without a pilot.

Uncharted dangers are reported to lie within 3 miles of the coast to the S and within 2 miles of the coast to the N of the mouth of the Rio Panuco. Considerable shoaling has been reported to extend up to 3 miles from the S breakwater.

A channel, 110m wide, leads across the bar and midway between the breakwaters into the river. The entrance bar has a controlling depth of 11m and is maintained by dredging. During the rainy season when the river is flooding, this depth will decrease due to heavy silting.

The principal wharves are situated on the N bank of the river. The public wharves provide about 850m of berthage; the private wharves provide about 2,285m of berthage.

A mineral ore-loading berth is situated on the N bank close S of Tampico Light.

Ciudad Madero, on the N bank about 1.5 miles within the river, is the principal oil terminal.

Fiscal Wharf, a general cargo berth, lies on the S side of the city. It is situated 6 miles within the entrance and has nine berths.

Puente Tampico, with a vertical clearance of 48m, crosses the river about 1.5 miles SW of the entrance to Canal del Chijol. For berthing information see the table titled **Tampico—Berth Information**.

**Aspect.**—The harbor area may be identified by the numerous chimneys and tanks of the oil refineries. The hills to the S of the river are grass-covered and higher than those to the N, which are composed of whitish-gray sand. On closer approach, Tampico Light, standing on the N side of the river entrance, and the light structures situated on the breakwater heads will be sighted.

**Tampico—Berth Information**

Berth	Length	Depth	Maximum Vessel		Remarks
			LOA	Beam	
PEMEX	102m	10.9m	—	—	Petroleum products
CEMEX Wharf No. 2	500m	8.5m	—	—	Cement, clinkers, and lime
Minera Autian	160m	6.7m	—	—	Bulk minerals
PROTAMSA	180m	9.1m	—	—	Agri-bulk, cement, and timber
Termimar	240m	9.1m	—	—	Bulk minerals
Del Golfo	500m	6.1m	—	—	Agri-bulk
Tergosa Public Terminal Docks No. 1-9	1,586m	10.0m	—	—	Containers, general cargo, and vehicles
Docks No. 10-11	576m	10.0m	—	—	General cargo and molassas
Docks No. 14-19	—	9.1m	—	—	
Dock No. 4, Berth No. 1	219m	10.0m	—	—	Cruise ships
Terminal Maritima Madero					
M-1	105m	11.5m	237m	32m	Petroleum products
M- 2	70m	11.5m	237m	32m	Petroleum, LPG, and aviation fuel
M- 3	70m	11.5m	237m	32m	Petroleum
M- 4	70m	11.5m	237m	32m	Petroleum.

Tampico—Berth Information					
Berth	Length	Depth	Maximum Vessel		Remarks
			LOA	Beam	
M- 5	70m	11.5m	237m	32m	Petroleum
Altimir Gas	—	9.0m	—	—	Maximum draft of 9.1m
Oil Petrochemical	240m	8.8m	121m	—	



Tampico



Tampico—N shore of the Rio Panuco



Tampico—from W to E toward breakwater

**Pilotage.**—Pilotage is compulsory for merchant vessels. Weather permitting, pilots board vessels by day or night from a launch about 2 miles outside the breakwater. Vessels may anchor there while awaiting the pilot. An ETA should be sent 48 hours in advance (24 hours if arriving from another Mexican port).

The pilots can be contacted, as follows:

1. VHF: VHF channels 12, 14, and 16
2. Telephone: 52-883-212-4749  
52-883-214-1728
3. Facsimile: 52-883-212-7305
4. E-mail: [pilotstampico24@prodigy.net.mx](mailto:pilotstampico24@prodigy.net.mx)



Tampico Light

**Anchorage.**—Anchorage can be taken within the river, but permission must be obtained. Several prohibited anchorage areas, which may be best seen on the chart, lie in the approaches.

**Directions.**—Vessels should enter with the lighted range



beacons bearing  $256^{\circ}30'$ , keeping a little N of the range to avoid the shoals. The current sets N across the entrance at times and vessels should enter at a sufficient speed to offset it.

**Caution.**—The smoke from the refineries may make the main white light appear red when the wind is from the SW and the humidity is high.

Several offshore platforms stand about 18 miles E of the entrance to the Rio Panuco. A number of submarine pipelines lie in this area and extend W to the shore.

A fish haven marked by a lighted buoy was reported (2004) to be situated about 11 miles NNE of La Barra Light.

It has been reported (2008) that a sand bank in the mouth of the Rio Panuco has reduced the depth in Puerto de Tampico to 8.68m at high tide.

## Tampico to the Rio Grande

**7.37 Altamira** ( $22^{\circ}25'N.$ ,  $97^{\circ}55'W.$ ), a general cargo terminal, is situated 14 miles NNW of La Barra Light. It consists of a wet dock with berths for 16 vessels. The controlling depth in the approaches is 12.5m. There is a marginal quay, 250m long, with a depth alongside of 13m and ro-ro facilities.

The port handles bulk, container, and general cargo. Vessels up to 50,000 dwt, 210m in length, and 10m draft can be accommodated.



**Altamira Light (foreground) and breakwater**

Pilotage is compulsory. The pilot boards about 2.3 miles E of the breakwater, as seen on the chart.

In late 2006, an LNG terminal currently under construction, is expected to begin operations. The terminal will consist of two storage tanks and be able to accommodate vessels with a capacity of up to  $200,000m^3$ .

**7.38** Between Tampico and Barra de Chavarria and Barra de La Trinidad, two shallow lagoon entrances lying 23 and 30 miles N, the coast is backed by wooded hills, about 60m high. A 5.5m shoal patch was reported (1912) to lie about 9 miles N of the Tampico harbor entrance. An obstruction was reported (1928) to lie 17 miles N of the Tampico harbor entrance. Shallow water lies up to 1.5 miles offshore between the entrances to the lagoons.

**Cerro Metate** ( $22^{\circ}47'N.$ ,  $97^{\circ}58'W.$ ), a flat-topped hill, 264m high, is located 32 miles NNW of Tampico.

Between Barra de La Trinidad and Barra del Torda, a shal-



**La Pesca Light**

low lagoon entrance lying 18 miles N, the coast is low and sandy. Some rocks lie up to 2 miles offshore in places.

Between Barra del Torda and the Rio Indios Morales ( $23^{\circ}24'N.$ ,  $97^{\circ}46'W.$ ), 28 miles N, the coast is backed by wooded hummocks, 21m high. **La Pesca** ( $23^{\circ}46'N.$ ,  $97^{\circ}44'W.$ ) is a fishing harbor located at the entrance to Rio Soto la Marina.

From abreast Punta Jerez, a range of hills, Sierra de San Jose de Las Rusias, extends 52 miles N at a distance of 7 to 12 miles inland. A conspicuous sugarloaf peak is located 18 miles SW of the Rio Indios Morales.

The coast between the Rio Indios Morales and the Rio Soto La Marina, 21 miles N, is bordered by a narrow strip of land that fronts a lagoon.

Between the Rio Soto La Marina and Boquillas Cerradas ( $25^{\circ}02'N.$ ,  $97^{\circ}30'W.$ ), 77 miles N, and the Rio San Fernando, 25 miles farther NNE, the coast is bordered by a strip of land 1 to 5 miles wide fronting Laguna de La Madre. The high hills in the interior terminate 24 miles N of the Rio Soto de La Marina.

A shoal, 3 miles in extent, lies 25 miles N of the Rio Soto La Marina. It is located about 2 miles offshore and has a least depth of 4.6m.

Boquillas Cerradas are four nearly closed entrances of Laguna de La Madre.

The **Rio San Fernando** ( $25^{\circ}23'N.$ ,  $97^{\circ}23'W.$ ), with a depth of 0.9m on the bar, drains a lagoon in the interior.

A shoal, 3 miles long, with a least depth of 3m, lies with its S

end located 5 miles N of the Rio San Fernando and about 3 miles offshore.

The **Rio Grande** (25°58'N., 97°09'W.), lying 36 miles N of

the Rio San Fernando, forms the boundary between the United States and Mexico. By international agreement, the river is closed to navigation.

## Dutch

DUTCH	English	DUTCH	English
<b>A</b>			
aan .....	at, near, on		
<b>B</b>		<b>L</b>	
baak .....	beacon	laag, lage .....	low
berg .....	mountain, hill	lang .....	long
binnen .....	inner	licht .....	light
blauwe .....	blue	loods .....	pilot
bol .....	ball	loodswezen .....	pilotage
boom .....	tree	<b>M</b>	
bocht .....	bay, bend, light	meer .....	inland sea
bosch .....	forest	middel, midden .....	middle
boschje .....	small wood, brush	modder .....	mud
breed .....	broad	molen .....	mill
brug .....	bridge	<b>N</b>	
buiten .....	outer	nauw .....	narrows
bult .....	hump	nieuw .....	new
<b>D</b>		noord .....	north
dam .....	dam, breakwater	noorder .....	northern
de, den .....	the	<b>O</b>	
diep .....	deep	oost .....	east
dijk .....	dike	oud .....	old
dorp .....	village	<b>P</b>	
draaikalk .....	eddy	peilschaal .....	tide gage
drempel .....	bar	plaat .....	shoal
dric .....	three	plaatje .....	small shoal
driehoek .....	triangle	plat .....	flat
droogte .....	shoal	polder .....	reclaimed land
duin .....	dune, sandhill	punt .....	point
dwars .....	across, athwart	<b>R</b>	
<b>E</b>		rak .....	channel
eiland .....	island	rechthoekig .....	rectangular
<b>F</b>		reddingboot .....	lifeboat
friesche .....	frisian	rede .....	roadstead
<b>G</b>		rode, rood .....	red
gat .....	channel	rots .....	rocks
geul .....	narrow channel	rug .....	ridge
groei .....	green	ruitvormig .....	diamond-shaped
gronden .....	grounds	<b>S</b>	
groot .....	great	schaar .....	channel
<b>H</b>		scherm .....	screen
haven .....	harbor	schor .....	shoal
helft .....	half	schutaluis .....	lock gate
het .....	the	seinen .....	signals
heuvel .....	hill	sluis .....	lock
hoek .....	cape, point	smal .....	narrow
hoofd .....	head	spits, spitse .....	pointed
hoog .....	high	spoorweg .....	railway
<b>K</b>		staart .....	tail (of a bank)
kaap .....	cape, headland	stad .....	town
kake .....	quay	steen .....	stone
kegel .....	cone	steiger .....	jetty, pier
kil .....	channel	steile .....	steep
klein .....	small	strand .....	beach, shore
klip .....	rock	stroom .....	current, stream
kop .....	head	<b>T</b>	
kreek .....	creek	toegang .....	access
kromme .....	crooked	tramweg .....	tramway
kust .....	coast	<b>U</b>	
		uit .....	out

DUTCH	English	DUTCH	English
<b>V</b>			
vaart .....	canal	watergetijden .....	tidal current
vaarwater .....	fairway	waterweg .....	waterway
valsch .....	false	weg .....	way
van .....	of	werk .....	work
veerboot.....	ferry	wester .....	western
verklikker .....	warning light	wit, witte .....	white
vlakke .....	flat below surface	wrak .....	wreck
vliegtuigen .....	aircraft	<b>Z</b>	
<b>W</b>			
wad .....	drying coastal bank	zand .....	sand
wal.....	banks, wall	zee .....	sea
		zeegat .....	estuary
		zuid .....	south

## French

FRENCH	English	FRENCH	English
<b>A</b>			
abri, abrite .....	shelter, sheltered	courant de jusant .....	ebb tidal current
aiguille .....	needle	crique .....	creek
aimante, e .....	magnetic	crue .....	freshet or flood
amer .....	landmark, beacon	<b>D</b>	
amont .....	upstream, landmark	darse .....	basin
anse .....	bay, creek	detroit .....	strait, narrow
apponnement .....	wharf, pier, quay	digue .....	breakwater, mole
argile .....	clay	douane .....	customhouse
atterrissage .....	making land, landfall	droit .....	right (side)
aval .....	downstream, seaward	due d'albe .....	dolphin
avant port .....	outer port	<b>E</b>	
azur .....	blue	echelle .....	scale
<b>B</b>			
babord .....	port	echelle de maree .....	tide gauge
baie .....	bay, gulf	ecluse .....	lock of a canal or basin
balisage .....	beaconage	ecueil .....	rock, breaker
balise .....	beacon	eglise .....	church
banc .....	bank, sandbank	encablure .....	cable's length, about 200m
barre .....	bar	entree .....	entrance, mouth of a river
basse .....	shoal	epave .....	wreck
basse mer .....	low water	epi .....	small jetty, groin
bassin .....	basin, dock	escarpe, e .....	bluff
bassin a flot .....	wet basin or dock	etale .....	(of tide) slack; (of wind) settled
bassin d'echouage .....	tidal basin where vessels ground	etang .....	lake
bateau de sauvetag .....	lifeboat	etiage .....	low-water mark of a river
blanc, he .....	white	etier .....	creek that can receive small vessels
bleu, bleue .....	blue	<b>F</b>	
bois .....	wood	falaise .....	cliff
bouche .....	mouth of a river	fanal .....	harbor lighthouse
bouee .....	buoy	feu .....	light
bouee a cloche .....	bell buoy	feu permanent .....	a light constantly burning and unwatched
bouee a sifflet .....	whistle buoy	fin, e .....	fine
bouee lumineuse .....	light buoy	fleche .....	soire
boussole .....	compass	fleuve .....	river, stream
brisant; brisants .....	shoals; breakers	flot .....	flood
brise-lames .....	breakwater	foc .....	jib (sail)
brouillard .....	fog, mist	fond .....	bottom
brume .....	fog	forme de radoub .....	drydock
<b>C</b>			
caboteur .....	coaster	fosse .....	ditch, a deep
cale de radoub .....	marine railway	<b>G</b>	
cap .....	cape, headland	galeta .....	shingle
champ-de-tir .....	firing range	gare .....	station
chapelle .....	chapel	gauche .....	left (side)
charbon .....	coal	golfe .....	gulf
chasse .....	a discharge of water from a reservoir	goulet .....	narrow entrance
chateau .....	castle	gravier .....	gravel
chaussee .....	bank, causeway	greve .....	sandy beach
chemin de fer .....	railroad	gril de carenage .....	gridiron
cheminee .....	chimney	gris .....	gray
chenal .....	channel	gros .....	coarse
clocher .....	steeple	guet .....	watch-house
coffre .....	mooring buoy	<b>H</b>	
colline .....	hill	haut .....	tall, high
compas .....	compass	haut-fond .....	a shoal
coquilles .....	shells	haute mer .....	high water
cote .....	coast	houle .....	swell
courant .....	current	<b>I</b>	
courant de flot .....	flood tidal current	hile .....	island, isle
		hilot .....	islet

FRENCH	English	FRENCH	English
<b>J</b>			
jaune.....	yellow	pointe.....	point
jetee.....	jetty	pont.....	bridge, deck
jusant.....	ebb	presq'ile.....	peninsula
<b>L</b>		<b>Q</b>	
lac.....	lake	quai.....	quay, wharf
<b>M</b>		<b>R</b>	
madrague.....	tunny net	rade.....	road, roadstead
marais.....	swamp, marsh	rafale.....	squall
maree.....	tide	raz (bas breton).....	a name given to a violent tidal current
maree descendante.....	falling tide	recif.....	reef
maree montante.....	rising tide	ressac.....	surf
massif.....	main group of mountains	roche.....	rock
mat.....	mast	rocher.....	rock, generally above water
mole.....	mole, pier	rouge.....	red
mortes eaux.....	neap tides	ruisseau.....	rivulet
mouillage.....	anchorage	<b>S</b>	
moulin.....	mill	sable.....	sand
musoir.....	pierhead	salines.....	salt-water lagoons, salt works
<b>N</b>		seche.....	dry shelf, flat
niveau.....	level	seuil.....	sill (as of a dock)
noeud.....	knot	sud.....	south
noir, noire.....	black	<b>T</b>	
nouveau, nouvel.....	new	temps.....	time, weather
<b>O</b>		tenue.....	holding ground
occidental, e.....	western	terre-plein.....	leveled ground, platform
onde.....	wave	tete.....	head
oriental, e.....	eastern	tour.....	tower
ouest.....	west	tourelle.....	small tower, turret
<b>P</b>		tribord.....	starboard
passe.....	pass, fairway, channel	<b>U</b>	
patente de sante.....	bill of health	usine.....	factory
pertuis.....	opening or strait	<b>V</b>	
petit, e.....	small	val.....	narrow valley
phare.....	lighthouse	vase.....	mud
pic.....	peak	vasiere.....	mudbank
pierre.....	stone	vent.....	wind
pin.....	pine or fir tree	vert.....	green
plage.....	shore, beach	vieux, vieil, vieille.....	old, ancient
plateau.....	tableland, or flat below water	ville.....	town
pleine mer.....	high water	vive-eau.....	spring tide

## Spanish

SPANISH	English	SPANISH	English
<b>A</b>			
abrigo .....	shelter	cubierta .....	deck
aduana .....	customhouse	cueva .....	cave
aguas muertas .....	neap tides	<b>D</b>	
aguas vivas .....	spring tides	darsena .....	dock or basin
aguja .....	needle	dique .....	dock, dike
albufera .....	tidal lake	dique seco .....	drydock
aldea .....	small village, a hamlet	draga .....	dredger
alfaque .....	sandbank, bar	<b>E</b>	
almadraba .....	tunny fishery	ensenada .....	bay or creek
alto .....	height	ermita .....	hermitage
amarillo .....	yellow	escollo .....	rock
arena .....	sand	espigon .....	a kind of wharf or pier
arrabal .....	suburb	estero .....	small creek
arrecife .....	reef	estrecho .....	strait
arroyo .....	rivulet	estribor .....	starboard
astillero .....	dockyard	<b>F</b>	
atalaya .....	an elevated place	fanal .....	lighthouse
<b>B</b>			
abor .....	port	fango .....	mud
bahia .....	bay	faro .....	light
bajamar .....	low water	ferrocarril .....	railway
bajo .....	shoal, under, low	fondeadero .....	anchorage
baliza .....	beacon	fondo .....	bottom, ground
banco .....	bank	fraile .....	friar
barlovento .....	windward	freo .....	strait
barra .....	bar at the mouth of a river or harbor	fuelle .....	fountain, spring of water
barrio .....	suburb, district of a town	fuerte .....	fort
blanco .....	white	<b>G</b>	
bote salavidas .....	lifeboat	garita .....	lookout house
boya .....	buoy	golfo .....	gulf
brazo .....	fathom	grande .....	great
brujula .....	compass	gris .....	gray
bruma .....	fog, haze	<b>I</b>	
buque .....	ship	iglesia .....	church
<b>C</b>			
cabezo .....	summit of a hill	isla .....	island
cabo .....	cape or headland	isleta .....	islet
cala .....	creek or small bay	<b>L</b>	
caleta .....	cove	lago .....	lake
camino de hierro .....	railway	laguna .....	lagoon
campanario .....	steeple, belfry	laja .....	flat rock
canal .....	channel or strait	limo .....	mud
capilla .....	chapel	lugar .....	village or small town
carabineros .....	a post of military coast guards	luz .....	light
carbon de piedra .....	coal	<b>M</b>	
carrazon .....	dark, cloudy weather	malecon .....	dike
carta de sanidad .....	bill of health	marea .....	tide
casa .....	house	marea creciente .....	flood tide
cascada .....	waterfall	marea menguante .....	ebb tide
cascajo .....	gravel	meridional .....	southern
caserio .....	series of houses	mesa .....	tableland
caseta .....	small house	molino .....	mill
castillo .....	castle	montana .....	mountain
cerro .....	hill	monte .....	mount
chico .....	small	muelle .....	mole or jetty
ciudad .....	city, town	<b>N</b>	
co .....	rock, shoal	negro .....	black
concha .....	a shell	niebla .....	fog
contrastes .....	winds blowing from opposite direction	norte .....	north

SPANISH	English	SPANISH	English
<b>O</b>			
ola.....	wave	ribera.....	the shore, the bank of a river
oriente.....	east	rio.....	river
<b>P</b>			
pardo.....	gray	roca.....	rock
pena.....	rock or large stone	rojo.....	red
penon.....	rock or rocky mountain	<b>S</b>	
pequena.....	small	saco.....	bay
picacho.....	summit	salina.....	saltpan
pico.....	peak	sanidad.....	health
piedra.....	rock	seno.....	gulf or bay
piloto.....	pilot	septentrional.....	northern
piloto practico ..a harbor pilot (practico is often used alone)		sierra.....	mountain ridge
placer.....	sandbank, cay	sud, sur.....	south
playa.....	beach	<b>T</b>	
pleamar.....	high water	temporal.....	storm
poniente.....	west	terral.....	land wind
promontono.....	headland, promontory	tiempo.....	weather
pueblo.....	town, village	torre.....	tower
puente.....	bridge	<b>V</b>	
puerto.....	port	variacion.....	variation
punta.....	point	vela.....	sail
<b>Q</b>			
quinta.....	country house	vendaval.....	strong sea wind
<b>R</b>			
reclada.....	making the land	verde.....	green
restinga.....	reef	viejo.....	old
ria.....	the mouth of a river	viento.....	wind
		vigia.....	a lookout, doubtful shoals
		villa.....	town
		virazon.....	sea breeze



## How to use the Index—Gazetteer

Geographic names of navigational features are generally those used by the nation having sovereignty and are listed alphabetically. Diacritical marks, such as accents, cedillas, and circumflexes, which are related to specific letters in certain foreign languages, are not used in the interest of typographical simplicity.

Geographic names or their spellings do not necessarily reflect recognition of the political status of an area by the United States Government. Positions are approximate and are intended merely as locators to facilitate reference to the charts.

**To use as a Gazetteer** note the position and Sector number of the feature and refer to the Chart Information diagram for the Sector. Plot the approximate position of the feature on this diagram and note the approximate chart number.

**To use as an Index** of features described in the text note the paragraph number at the right. To locate this feature on the best scale chart use the Gazetteer procedure above.

### Index—Gazetteer

	Position			Sec. Para		Position			Sec. Para
	°	'	''			°	'	''	
<b>A</b>									
ACANDI	8	31 N	77 16 W	4.25	BAHIA HARAPOS	10	15 N	64 29 W	2.49
ALICE SHOAL	16	05 N	79 18 W	5.60	BAHIA HONDITA	12	24 N	71 44 W	4.2
ALMIRANTE	9	18 N	82 24 W	5.20	BAHIA LA MAR	10	55 N	63 50 W	2.38
ALTAGRACIA	10	42 N	71 32 W	3.15	BAHIA NOMBRE DE DIOS	9	35 N	79 28 W	4.30
ALTAMIRA	22	25 N	97 55 W	7.37	BAHIA NORTE	11	02 N	64 05 W	2.36
ALVARADO	18	47 N	95 46 W	7.29	BAHIA PAMPATAR	10	59 N	63 50 W	2.37
ALVARO OBREGON	18	35 N	92 39 W	7.18	BAHIA SAN CRISTOBAL	9	37 N	79 30 W	4.30
AMBERGRIS CAY	18	02 N	87 55 W	6.62	BAJIO CARACA	10	24 N	64 27 W	2.48
AMBROSIO BIGHT	9	16 N	82 22 W	5.18	BAJIO TORTUGA	10	05 N	75 52 W	4.18
AMUAY	11	45 N	70 14 W	3.4	BAJO ALDEN	9	28 N	79 03 W	4.28
ANCON DE TAGANGA	11	16 N	74 12 W	4.8	BAJO BLAKE	20	45 N	96 58 W	7.27
ANTON LIZARDO ANCHORAGE	19	04 N	95 59 W	7.30	BAJO DE ARAYA	10	39 N	64 18 W	2.45
ARAYA	10	34 N	64 17 W	2.45	BAJO DE TUXPAN	21	01 N	97 12 W	7.27
ARRECIFE ALACRAN	22	29 N	89 42 W	7.3	BAJO GRANDE	10	31 N	71 38 W	3.18
ARRECIFE ANEGADA DE ADETRON	19	14 N	96 04 W	7.31	BAJO MERSEY	19	11 N	96 06 W	7.31
ARRECIFE ANEGADA DE AFUERA	19	09 N	95 51 W	7.26	BAJO NUEVO	15	53 N	78 33 W	5.60
ARRECIFE CHOPAS	19	05 N	95 58 W	7.26	BAJO NUEVO	21	50 N	92 05 W	7.5
ARRECIFE DE LA MEDIA LUNA	15	13 N	82 38 W	6.5	BAJO PADUCAH	19	12 N	96 05 W	7.31
ARRECIFE MADAGASCAR	21	26 N	90 18 W	7.3	BAJO PAJARO	11	43 N	72 44 W	4.6
ARRECIFE SANTIAGUILLO	19	09 N	95 48 W	7.26	BAJO SOLARTE	9	20 N	82 13 W	5.15
ARRECIFE SISAL	21	21 N	90 09 W	7.11	BAJO VILLED0	15	45 N	88 37 W	6.39
ARRECIFES TRIANGULOS	20	57 N	92 14 W	7.5	BANCO BURGANO	11	50 N	65 55 W	2.6
ARROWSMITH BANK	21	05 N	86 25 W	6.80	BANCO CHINCHORRO	18	35 N	87 27 W	6.69
ARUBA	10	30 N	70 00 W	2.21	BANCO DEL CABO	15	16 N	82 57 W	6.6
AUIAPUNI REEF	14	31 N	83 05 W	5.43	BANCO PERA	20	42 N	91 56 W	7.6
AVE DE BARLOVENTO	11	58 N	67 26 W	2.9	BANCO PROVIDENCIA	15	55 N	86 38 W	6.30
AVE DE SOTAVENTO	12	00 N	67 40 W	2.9	BANCO SALMEDINA	15	55 N	87 05 W	6.31
AYO SUCIO	21	25 N	86 53 W	6.81	BANCO SMITH	16	17 N	86 35 W	6.21
<b>B</b>									
BAAI VAN VALENTIJJN	12	07 N	68 56 W	2.17	BANCO VIVORILLO	15	54 N	83 22 W	6.8
BACHAQUERO	9	57 N	71 10 W	3.22	BANCOS DE CHAMPOTON	19	23 N	90 50 W	7.13
BAHIA CATALINA	13	23 N	81 23 W	5.54	BANCOS DE SABANCUY	19	10 N	91 16 W	7.13
BAHIA CHUSPA	10	37 N	66 20 W	2.59	BANCOS DE SALMEDINA	10	23 N	75 40 W	4.15
BAHIA CISPATA	9	25 N	75 47 W	4.21	BANCOS DEL CABO FALSO	15	32 N	83 03 W	6.7
BAHIA CRUZ	10	16 N	64 27 W	2.49	BANCOS INGLESES	21	49 N	91 56 W	7.5
BAHIA DE AMATIQUE	15	56 N	88 44 W	6.39	BARRA DE PUERTO REAL	18	47 N	91 30 W	7.15
BAHIA DE AMUAY	11	45 N	70 14 W	3.4	BARRA DE TUPILCO	18	26 N	93 25 W	7.21
BAHIA DE COMONA	10	15 N	64 32 W	2.49	BEACON CAY	15	47 N	79 50 W	5.59
BAHIA DE LA ASCENSION	19	41 N	87 30 W	6.71	BELIZE CITY	17	30 N	88 11 W	6.64
BAHIA DE LAS MINAS	9	24 N	49 49 W	4.34	BIG CREEK	16	30 N	88 25 W	6.48
BAHIA DE MANGLE	10	56 N	64 10 W	2.41	BLACK BLUFF	11	37 N	83 39 W	5.28
BAHIA DE MOIN	10	00 N	83 05 W	5.23	BLOWING ROCK	12	02 N	83 02 W	5.31
BAHIA DE MUJERES	21	13 N	86 46 W	6.79	BLUE CHANNEL	14	25 N	82 50 W	5.42
BAHIA DE PERTIGALETE	10	15 N	64 34 W	2.50	BLUE GROUND RANGE	16	48 N	88 09 W	6.56
BAHIA DE PORTETE	12	15 N	71 55 W	4.2	BLUEFIELDS	12	01 N	83 45 W	5.30
BAHIA DE SABANILLA	11	00 N	75 00 W	4.14	BOCA BACALAR CHICO	18	11 N	87 52 W	6.68
BAHIA DE SAN ANDRES	12	35 N	81 42 W	5.52	BOCA DE CANIL	21	29 N	87 35 W	7.8
BAHIA DE SAN JUANGRIEGO	11	05 N	64 00 W	2.35	BOCA DE HUEVOS	10	41 N	61 42 W	1.22
BAHIA DE TELA	15	47 N	87 27 W	6.32	BOCA DE MONOS	10	42 N	61 40 W	1.21
BAHIA DE TRUJILLO	15	58 N	86 00 W	6.25	BOCA DEL DRAGO	9	25 N	82 20 W	5.16
BAHIA DE ZISPATA	9	25 N	75 47 W	4.21	BOCA GRANDE	10	42 N	61 48 W	1.23
BAHIA DEL ESPIRITU SANTO	19	22 N	87 28 W	6.71	BOCA PLAJA CANOA	12	11 N	68 52 W	2.15
BAHIA ESTANQUES	11	49 N	70 16 W	3.3	BOCA SANTA CRUZ	12	18 N	69 09 W	2.15
BAHIA GUAMACHE	10	53 N	64 05 W	2.39	BOCAS DE CENIZA	11	06 N	74 51 W	4.13
					BOCAS DEL TORO	9	21 N	82 14 W	5.19
					BODEN REEF	12	30 N	83 19 W	5.33
					BONACCA ISLAND	16	28 N	85 54 W	6.17
					BONAIRE	12	09 N	68 17 W	2.10
					BOPEC TERMINAL	12	13 N	68 23 W	2.13
					BOQUILLAS CERRADAS	25	02 N	97 30 W	7.38

	Position				Sec. Para		Position				Sec. Para
	o	'	o	'			o	'	o	'	
BRIGHTON	10	15 N	61	38 W	1.41	CERRO ESCONDIDO	10	23 N	64	17 W	2.48
BRUJAS POINT	9	21 N	79	59 W	5.2	CERRO METATE	22	47 N	97	58 W	7.38
BUGLE CAYS	16	29 N	88	19 W	6.47	CERRO PAYAS	15	45 N	84	56 W	6.12
BULLENBAAI	12	11 N	69	01 W	2.16	CERRO SANGRELAYA	15	52 N	85	09 W	6.14
						CERRO TORTUGUERO	10	35 N	83	30 W	5.25
						CERRO UNARE	10	05 N	65	15 W	2.57
<b>C</b>						CERU COLORADO	12	25 N	69	52 W	2.22
CABEZA PIEDRA GRANDE	15	54 N	85	29 W	6.14	CERU GRANI	12	11 N	68	15 W	2.11
CABIMAS	10	23 N	71	29 W	3.20	CHACACHACARE ISLAND	10	41 N	61	45 W	1.22
CABO BLANCO	10	37 N	66	59 W	2.61	CHAGUARAMAS BAY	10	40 N	61	39 W	1.30
CABO CAMARON	16	00 N	85	00 W	6.13	CHAMPOTON	19	22 N	90	43 W	7.15
CABO CATOCHE	21	36 N	87	04 W	7.8	CHARLOTTESVILLE	11	19 N	60	33 W	1.3
CABO CODERA	10	35 N	66	03 W	2.58	CHIMANA DEL OESTE	10	18 N	64	41 W	2.53
CABO DE LA AGUJA	11	18 N	74	12 W	4.8	CHIMANA GRANDE	10	18 N	64	40 W	2.53
CABO DE LA ISLA	11	10 N	63	53 W	2.35	CHUPARA POINT	10	49 N	61	22 W	1.13
CABO DE LA VELA	12	13 N	72	10 W	4.4	CIUDAD BOLIVAR	8	08 N	63	33 W	1.60
CABO FALSO	15	12 N	83	20 W	6.10	CIUDAD CHETUMAL	18	30 N	88	17 W	6.67
CABO GRACIAS A DIOS	15	00 N	83	09 W	6.10	CLAXTON BAY MARINE TERMINAL	10	21 N	61	28 W	1.37
CABO GRACIAS A DIOS	15	00 N	83	10 W	5.48	COATZACOALCOS	18	08 N	94	25 W	7.22
CABO NEGRO	11	10 N	63	53 W	2.35	COCO PLUM POINT	9	02 N	81	43 W	5.6
CABO ROJO	21	33 N	97	20 W	7.35	COCOA PLUM CAY	16	53 N	88	07 W	6.56
CABO SAN ROMAN	12	11 N	70	00 W	3.3	COLONCHA	9	12 N	71	45 W	3.25
CABO TIBURON	8	41 N	77	22 W	4.26	COLSON POINT	17	04 N	88	15 W	6.51
CABO TORO	9	22 N	82	12 W	5.13	COLUMBUS POINT	11	08 N	60	48 W	1.9
CABO TRES PUNTAS	15	58 N	88	37 W	6.38	COMMANDEURS BAAI	12	27 N	69	57 W	2.24
CALETA GUARANAO	11	40 N	70	13 W	3.7	CONCEPCION,	17	37 N	92	49 W	7.24
CAMPECHE	19	51 N	90	33 W	7.14	COROZAL	18	22 N	88	24 W	6.67
CANAL CAOBAS	9	33 N	78	40 W	4.28	COURLAND POINT	11	13 N	60	47 W	1.3
CANAL DE BOCAS DEL TORO	9	20 N	82	15 W	5.15	COVENAS	9	25 N	75	41 W	4.19
CANAL DE MARGARITA	10	50 N	64	00 W	2.42	COVENAS TANKER TERMINAL	9	32 N	75	47 W	4.20
CANAL DEL SUR	11	56 N	66	39 W	2.8	COXEN HOLE	16	19 N	86	33 W	6.21
CANAL DEL TIGRE	9	11 N	81	59 W	5.10	CRAWL CAY CHANNEL	9	14 N	82	08 W	5.13
CANAL MAYFLOWER	9	33 N	78	45 W	4.28	CROWN POINT	11	09 N	60	51 W	1.5
CANAL VALIENTE	9	12 N	81	55 W	5.9	CUMBERLAND BANK	11	12 N	63	08 W	2.3
CANGREJO CAY	17	52 N	88	02 W	6.66	CURACAO	12	10 N	68	58 W	2.15
CANGREJOS POINT	10	26 N	61	30 W	1.34	CURACAO OIL TERMINAL	12	11 N	69	01 W	2.16
CAPE GRACIAS-A-DIOS	11	14 N	60	32 W	1.6	CUYO	21	32 N	87	41 W	7.8
CAPE THREE POINTS	15	58 N	88	37 W	6.38						
CARACASBAAI	12	04 N	68	52 W	2.18	<b>D</b>					
CARENAGE BAY	10	41 N	61	36 W	1.32	DARIEN ROCK	10	32 N	60	38 W	1.11
CARIPITO	10	10 N	63	02 W	1.51	DELAWARE BANK	10	50 N	60	25 W	1.10
CARMEN	18	39 N	91	50 W	7.16	DIAMOND ROCK	10	40 N	61	46 W	1.23
CARTAGENA	10	25 N	75	32 W	4.16	DIEGO ISLANDS	10	39 N	61	38 W	1.31
CASTILLETES ANCHORAGE	11	49 N	71	20 W	3.11	DOS BOCAS TERMINAL	18	25 N	93	08 W	7.20
CATALINA HARBOR	13	23 N	81	23 W	5.54	DOS HERMANOS	20	06 N	96	52 W	7.33
CATIA LA MAR	10	36 N	67	02 W	2.61	DRAGONS MOUTH	10	42 N	61	45 W	1.21
CAY BOKEL	17	10 N	87	54 W	6.61	DREW BANK	11	05 N	60	50 W	1.9
CAY CORKER	17	47 N	88	01 W	6.66	DREW SHOAL	11	05 N	60	54 W	1.9
CAYMAN ROCA	12	05 N	83	39 W	5.34	DRUIF	12	32 N	70	04 W	2.27
CAYO ARCAS TERMINAL	20	10 N	91	59 W	7.7						
CAYO ARENAS	22	07 N	91	24 W	7.4	<b>E</b>					
CAYO BORRACHA	10	18 N	64	45 W	2.53	EAST CAY	15	52 N	79	44 W	5.59
CAYO BORRACHO	10	58 N	68	15 W	2.68	EAST CAY CHANNEL	14	21 N	80	11 W	5.57
CAYO CARENERO	9	21 N	82	14 W	5.14	EAST HARBOR	16	06 N	86	54 W	6.23
CAYO CENTRO	18	36 N	87	20 W	6.69	EASTERN CHANNEL	10	02 N	61	56 W	1.27
CAYO CORDOBA	12	33 N	81	41 W	5.52	EDINBURGH REEF	14	50 N	82	39 W	5.45
CAYO DE PLATANOS	9	08 N	81	48 W	5.7	EGG ROCK	13	02 N	83	22 W	5.36
CAYO FRANCES	11	58 N	66	39 W	2.8	EL BLUFF	12	00 N	83	41 W	5.29
CAYO GORDA	15	52 N	82	24 W	6.6	EL BORRACHO	10	16 N	64	45 W	2.53
CAYO NAMANS	11	56 N	66	40 W	2.8	EL CHAURE	10	15 N	64	37 W	2.54
CAYO NORDESTE	11	52 N	66	06 W	2.6	EL PALITO	10	30 N	68	07 W	2.67
CAYO NORTE	18	45 N	87	19 W	6.69	EL ROQUE	11	58 N	66	41 W	2.7
CAYO SOLARTE	9	19 N	82	11 W	5.13	EL TABLAZO	10	45 N	71	32 W	3.15
CAYOS ARCAS	20	13 N	91	58 W	7.6	EL VIGIA	10	36 N	66	56 W	2.60
CAYOS BECERRO	15	55 N	83	16 W	6.8	EM LIGHTED BUOY	11	14 N	71	34 W	3.12
CAYOS CAJONES	16	06 N	83	13 W	6.9	ENSENADA AMBROSIO	9	16 N	82	22 W	5.18
CAYOS CARATASCA	16	02 N	83	20 W	6.8	ENSENADA CARIAQUITA	10	40 N	61	54 W	1.45
CAYOS COCHINOS	15	58 N	86	34 W	6.30	ENSENADA DE CALABOZO	11	24 N	71	40 W	3.11
CAYOS COCOROCUMA	15	43 N	83	00 W	6.7	ENSENADA DE CORSARIOS	10	35 N	66	04 W	2.59
CAYOS DE ALBUQUERQUE	12	10 N	81	51 W	5.49	ENSENADA GARRAPATA	10	39 N	63	26 W	2.31
CAYOS DE PERLAS	12	29 N	83	19 W	5.33	ENSENADA LA ESMERALDA	10	39 N	63	30 W	2.32
CAYOS DEL ESTE SUDESTE	12	24 N	81	28 W	5.50	ENSENADA LA GUARDIA	11	02 N	64	05 W	2.36
CAYOS MAN O WAR	13	01 N	83	23 W	5.36	ENSENADA UNARE	10	44 N	62	45 W	2.28
CAYOS MISKITOS	14	23 N	82	46 W	5.42	ENTRADA POINT	10	43 N	61	40 W	1.15
CAYOS PICHONES	15	45 N	82	56 W	6.8	ESCUDO DE VERAGUAS	9	06 N	81	34 W	5.6
CAYOS TIGRE	9	13 N	81	55 W	5.8	EUREKA	8	57 N	82	07 W	5.11
CAYOS VIVORILLO	15	50 N	83	18 W	6.8						
CEDROS BAY	10	07 N	61	52 W	1.43						
CERRO CARDONA	15	53 N	87	51 W	6.35						



	Position			Sec. Para		Position			Sec. Para
	o	'				o	'		
MANSHEBU	12	32 N	70 04 W	2.27	PROGRESO	21	17 N	89 40 W	7.10
MANZANILLA BANK	10	24 N	60 54 W	1.11	PUERTO BARRIOS	15	44 N	88 36 W	6.40
MANZANILLA BAY	10	30 N	61 01 W	1.16	PUERTO BOLIVAR	12	16 N	71 57 W	4.3
MANZANILLA POINT	10	31 N	61 01 W	1.15	PUERTO BORBURATA	10	29 N	67 59 W	2.64
MARACAIBO	10	38 N	71 36 W	3.16	PUERTO CABELLO	10	29 N	68 00 W	2.65
MARACAS BAY	10	46 N	61 26 W	1.13	PUERTO CABEZAS	14	01 N	83 23 W	5.39
MARAVACA ISLET	10	46 N	61 31 W	1.14	PUERTO CARDON	11	37 N	70 14 W	3.8
MARTIN POINT	10	40 N	61 34 W	1.32	PUERTO CARRENERO	10	32 N	66 07 W	2.58
MAUGER CAY	17	36 N	87 46 W	6.61	PUERTO CARUPANO	10	40 N	63 15 W	2.30
MCMILLAN ROCK	10	37 N	60 59 W	1.15	PUERTO CASTILLA	16	00 N	85 58 W	6.26
MELVILLE ISLANDS	11	21 N	60 31 W	1.2	PUERTO CHICHIRIVICHE	10	55 N	68 16 W	2.70
MINATITLAN	18	00 N	94 32 W	7.24	PUERTO CORTES	15	50 N	87 57 W	6.36
MISKITO REEF	14	28 N	82 42 W	5.42	PUERTO CRISTOBAL	9	21 N	79 55 W	4.37
MISTERIOSA BANK	18	51 N	83 50 W	6.5	PUERTO CUMAREBO	11	29 N	69 21 W	2.74
MOHO CAY	16	30 N	88 10 W	6.63	PUERTO DE BARRANQUILLA	11	00 N	74 48 W	4.13
MONKEY CAY	9	10 N	82 15 W	5.12	PUERTO DE HIERRO	10	38 N	62 05 W	1.47
MONKEY SHOAL	16	23 N	88 25 W	6.47	PUERTO DE OCUMARE	10	29 N	67 46 W	2.62
MONTE CUCRA	12	15 N	83 46 W	5.34	PUERTO DE YUKALPETEN	21	17 N	89 43 W	7.11
MORRO BLANCO	10	41 N	63 20 W	2.31	PUERTO EL GUAMACHE	10	52 N	64 04 W	2.40
MORRO CHORONI	10	31 N	67 36 W	2.62	PUERTO EL ROQUE	11	57 N	66 39 W	2.8
MORRO DE BARCELONA	10	13 N	64 43 W	2.55	PUERTO ESTE	16	06 N	86 54 W	6.23
MORRO DE CHACOPATA	10	42 N	63 49 W	2.32	PUERTO GAROTE	9	36 N	79 35 W	4.32
MORRO DE LEBRANCHE	10	41 N	63 28 W	2.31	PUERTO ISABEL	13	22 N	83 34 W	5.37
MORRO DEL PUERTO SANTO	10	43 N	63 10 W	2.29	PUERTO JOSE	10	06 N	64 51 W	2.56
MORUGA POINT	10	05 N	61 16 W	1.18	PUERTO LA CRUZ	10	14 N	64 38 W	2.54
MUTINE SHOAL	17	15 N	88 09 W	6.52	PUERTO LA CRUZ	10	33 N	67 21 W	2.62
					PUERTO LA GUAIRO	10	37 N	66 56 W	2.60
					PUERTO LIMON	10	00 N	83 01 W	5.22
<b>N</b>					PUERTO MACURO	10	39 N	61 56 W	1.46
NANCHITAL	18	04 N	94 25 W	7.24	PUERTO MANTANZAS	8	17 N	62 51 W	1.59
NANCY SHOAL	9	20 N	82 13 W	5.15	PUERTO MIRANDA	10	46 N	71 33 W	3.14
NED THOMAS CAY	14	10 N	82 48 W	5.44	PUERTO MOCHIMA	10	24 N	64 21 W	2.48
NEWPORT	12	03 N	68 50 W	2.20	PUERTO MOIN	10	00 N	83 05 W	5.24
NOORDPUNT	12	24 N	69 09 W	2.15	PUERTO MORELOS	20	51 N	86 54 W	6.76
NORTH CAY	14	28 N	80 17 W	5.57	PUERTO MUJERES	21	16 N	86 45 W	6.79
NORTH ROCK	11	16 N	63 45 W	2.3	PUERTO ORCHILLA	11	51 N	66 06 W	2.6
					PUERTO ORDAZ	8	21 N	62 43 W	1.58
					PUERTO PEDERNALES	9	59 N	62 15 W	1.53
					PUERTO PERME	8	45 N	77 32 W	4.27
					PUERTO PIRITU	10	04 N	65 02 W	2.57
					PUERTO REAL	16	25 N	86 19 W	6.20
					PUERTO RIO CARIBE	10	42 N	63 07 W	2.28
OBISPO NORTE	20	29 N	92 12 W	7.6	PUERTO SANTO TOMAS DE CASTILLA	15	42 N	88 37 W	6.41
ORANGE POINT	16	05 N	88 49 W	6.44	PUERTO SUCRE	10	28 N	64 11 W	2.47
OUTHWEST CAYS	16	43 N	87 51 W	6.59	PUERTO TURIAMO	10	27 N	67 51 W	2.62
OX TONGUE SHOAL	15	53 N	88 38 W	6.39	PUERTO VERACRUZ	19	12 N	96 08 W	7.32
					PUERTO ZUNIGA	11	08 N	74 13 W	4.12
					PUNTA ADARO	11	44 N	70 14 W	3.5
<b>P</b>					PUNTA ADICORA	11	56 N	69 48 W	2.77
PAARDEN BAAI	12	31 N	70 02 W	2.26	PUNTA AGUIDE	11	21 N	68 42 W	2.72
PAJARITOS	18	09 N	94 25 W	7.23	PUNTA ARBOLETES	8	53 N	76 26 W	4.22
PALMAREJO	10	48 N	71 40 W	3.13	PUNTA ARENAS	10	20 N	62 38 W	1.49
PALUA	8	22 N	62 41 W	1.57	PUNTA ARENAS DEL NORTE	8	33 N	76 56 W	4.24
PAMATACUAL	10	14 N	64 34 W	2.51	PUNTA BAJA	9	31 N	60 58 W	1.55
PAMPATAR	10	59 N	63 48 W	2.37	PUNTA BLANCA	10	00 N	83 02 W	5.21
PAUNCH CAY	17	24 N	88 02 W	6.57	PUNTA BOMBEADOR	9	55 N	61 40 W	1.54
PAYO OBISPO	18	30 N	88 17 W	6.67	PUNTA BOROJO	11	11 N	70 52 W	3.9
PICO ZEMPOALA	19	33 N	96 27 W	7.33	PUNTA BOXCOHUO	21	02 N	90 18 W	7.12
PIGEON CAYS	15	45 N	82 56 W	6.8	PUNTA BRAVA	10	30 N	68 01 W	2.63
PIGEON POINT	11	10 N	60 50 W	1.5	PUNTA BRAVA	12	00 N	69 50 W	2.77
PITCH POINT	10	15 N	61 37 W	1.40	PUNTA BRAVA	9	15 N	78 03 W	4.28
PLACENTIA POINT	16	31 N	88 22 W	6.62	PUNTA BUEY	18	39 N	92 43 W	7.17
PLACENTIA POINT	18	31 N	88 22 W	6.49	PUNTA CABALLOS	15	50 N	87 58 W	6.35
PLANTAIN CAY	9	08 N	81 48 W	5.7	PUNTA CAIMAN	8	16 N	76 46 W	4.24
PLUM CAY	16	53 N	88 07 W	6.62	PUNTA CANOAS	10	34 N	75 31 W	4.15
POINT FORTIN	10	11 N	61 41 W	1.42	PUNTA CANON	12	23 N	71 49 W	4.2
POINT GALBA	10	15 N	61 38 W	1.42	PUNTA CARABALLEDA	10	37 N	66 51 W	2.59
POINT LISAS INDUSTRIAL PORT	10	24 N	61 30 W	1.35	PUNTA CARIBANA	8	37 N	76 53 W	4.23
POINT ROUGE	10	09 N	61 47 W	1.43	PUNTA CARMONA	10	38 N	62 09 W	1.47
POINTE-A-PIERRE	10	19 N	61 28 W	1.38	PUNTA CARNER	10	07 N	62 57 W	1.50
POMPION CAY	16	24 N	88 06 W	6.55	PUNTA CARNERO	10	53 N	64 01 W	2.39
POND CAY	16	26 N	85 54 W	6.17	PUNTA CARRIZAL	12	01 N	72 11 W	4.5
PONDSOCK REEF	9	17 N	82 20 W	5.18	PUNTA CASTILLETES	11	50 N	72 20 W	4.5
PORREE CHANNEL	14	26 N	82 41 W	5.42	PUNTA CASTILLO	10	56 N	83 40 W	5.26
PORK AND DOUGHBOY POINT	16	11 N	88 44 W	6.46	PUNTA CAURO	9	26 N	82 19 W	5.14
PORLAMAR	10	57 N	63 51 W	2.38	PUNTA CAXINAS	16	02 N	86 01 W	6.24
PORT LISAS POINT	10	23 N	61 29 W	1.36	PUNTA CAYO DE AGUA	9	09 N	82 00 W	5.10
PORT OF SPAIN	10	39 N	61 31 W	1.33	PUNTA CHICHIRIVICHE	10	55 N	68 16 W	2.69
PORTOBELO	9	33 N	79 40 W	4.33	PUNTA CIENAGAS	11	11 N	70 52 W	3.9
POS CHIKITU	12	34 N	70 04 W	2.27	PUNTA COAICA	8	48 N	81 17 W	5.6
POYAS PEAK	15	45 N	84 56 W	6.12	PUNTA COCO	9	18 N	82 16 W	5.19
POZOS COLORADOS	11	09 N	74 15 W	4.11	PUNTA COCO SOLO	9	23 N	79 53 W	4.37

	Position			Sec. Para		Position			Sec. Para
	°	'				°	'		
PUNTA COCOLI	15	53 N	88 49 W	6.43					
PUNTA CONGREJAL	15	47 N	86 51 W	6.28					
PUNTA COYAL	19	03 N	95 58 W	7.30					
PUNTA DE LA AGUADA	11	51 N	64 39 W	2.4					
PUNTA DE LA GARITA	10	48 N	75 16 W	4.14					
PUNTA DE OMOA	15	47 N	88 03 W	6.37					
PUNTA DE PALMAS	10	24 N	71 34 W	3.19					
PUNTA DE PARGO	9	12 N	82 19 W	5.17					
PUNTA DEL TACQUIEN	10	41 N	63 23 W	2.31					
PUNTA DELGADO	10	41 N	61 40 W	1.29					
PUNTA ESPADA	12	05 N	71 07 W	3.10					
PUNTA ESPERANZA	9	37 N	79 38 W	4.32					
PUNTA FRAYLE	10	43 N	63 02 W	2.28					
PUNTA GAIRA	11	13 N	74 14 W	4.10					
PUNTA GALLINAS	12	28 N	71 40 W	3.10					
PUNTA GORDA	10	10 N	62 38 W	1.49					
PUNTA GORDA	10	20 N	64 28 W	2.49					
PUNTA GORDA	14	21 N	83 12 W	5.40					
PUNTA GORDA	16	06 N	88 48 W	6.45					
PUNTA GUARAGUARA	10	32 N	62 19 W	1.49					
PUNTA GUARAPOTURA	10	39 N	63 42 W	2.32					
PUNTA HERRERIA	15	49 N	88 44 W	6.42					
PUNTA HERRERO	19	18 N	87 26 W	6.71					
PUNTA ICACA	9	02 N	81 43 W	5.6					
PUNTA LAS VACAS	8	04 N	76 44 W	4.24					
PUNTA MACOLLA	12	06 N	70 13 W	3.3					
PUNTA MACOLLA,	9	36 N	79 26 W	4.29					
PUNTA MANDINGA	9	28 N	78 58 W	4.28					
PUNTA MANZANILLA	9	38 N	79 33 W	4.30					
PUNTA MANZANILLO	10	38 N	63 35 W	2.32					
PUNTA MANZANILLO	11	32 N	69 16 W	2.73					
PUNTA MARGARITA	9	23 N	79 53 W	4.35					
PUNTA MASPARRO	10	39 N	66 14 W	2.59					
PUNTA MATA REDONDA	10	12 N	62 31 W	1.52					
PUNTA MICO	11	36 N	83 40 W	5.55					
PUNTA MOLAS	20	35 N	86 44 W	6.75					
PUNTA MONA	9	38 N	82 37 W	5.21					
PUNTA MONO	11	36 N	83 40 W	5.27					
PUNTA MUERTO	9	00 N	82 15 W	5.11					
PUNTA NAIGUATA	10	37 N	66 45 W	2.59					
PUNTA NEGRA	16	16 N	88 33 W	6.46					
PUNTA NOHKU	19	37 N	87 28 W	6.71					
PUNTA NORTE	12	36 N	81 42 W	5.51					
PUNTA OBISPO	15	51 N	87 23 W	6.32					
PUNTA PAJAROS	19	34 N	87 25 W	6.71					
PUNTA PATUCA	15	49 N	84 17 W	6.11					
PUNTA PENAS	10	44 N	61 51 W	1.44					
PUNTA PESCADOR	9	36 N	79 28 W	4.29					
PUNTA PESCADOR	9	53 N	61 39 W	1.54					
PUNTA PIEDRAS	10	35 N	71 36 W	3.17					
PUNTA PIEDRAS	9	20 N	76 05 W	4.22					
PUNTA REVERA	8	16 N	76 57 W	4.25					
PUNTA RINCON	9	01 N	80 41 W	5.4					
PUNTA ROCA PARTIDA	18	42 N	95 11 W	7.28					
PUNTA SABANILLA	8	44 N	76 38 W	4.22					
PUNTA SAL	15	55 N	87 36 W	6.34					
PUNTA SAN BERNARDO	9	42 N	75 42 W	4.18					
PUNTA SAN BLAS	9	34 N	78 58 W	4.29					
PUNTA SAN JUAN	11	11 N	68 24 W	2.71					
PUNTA SAN JUAN	18	17 N	94 37 W	7.25					
PUNTA SAN JUAN	8	48 N	76 31 W	4.22					
PUNTA SARABETA	9	26 N	82 20 W	5.17					
PUNTA SUR	12	29 N	81 44 W	5.51					
PUNTA TAIMATAIMA	11	30 N	69 31 W	2.74					
PUNTA TERRABA	9	26 N	82 21 W	5.21					
PUNTA TOLETE	10	02 N	62 12 W	1.52					
PUNTA TOMATEY	12	10 N	69 56 W	2.77					
PUNTA TORO	9	22 N	82 12 W	5.13					
PUNTA TUCACAS	10	52 N	68 14 W	2.68					
PUNTA TUMATEY	12	10 N	69 56 W	2.77					
PUNTA TUNA	10	38 N	63 57 W	2.33					
PUNTA VALIENTE	9	11 N	81 55 W	5.8					
PUNTA VARADERO	10	55 N	68 16 W	2.69					
PUNTA YAAN	20	11 N	87 27 W	6.72					
PUNTA YALKUBUL	21	32 N	88 37 W	7.9					
PUNTA YCACOS	16	15 N	88 35 W	6.46					
PUNTA YERBASAL	8	16 N	76 57 W	4.25					
PUNTA ZAMURO	11	27 N	68 50 W	2.73					
PUNTA ZAPOTITLAN	18	33 N	94 48 W	7.25					
					<b>Q</b>				
					QUAMINO CAY	16	39 N	88 13 W	6.63
					QUARANTINE ISLANDS	10	39 N	61 36 W	1.32
					QUEEN'S ISLAND	11	14 N	60 33 W	1.6
					QUITA SUEÑO BANK	14	15 N	81 15 W	5.58
					<b>R</b>				
					RADIX POINT	10	20 N	60 58 W	1.16
					RANGUANA CAY	16	20 N	88 10 W	6.55
					REAL DE LAS SALINAS	20	45 N	90 26 W	7.13
					RED ROCKS	11	10 N	60 45 W	1.8
					RIO AROA	10	41 N	68 18 W	2.68
					RIO CANDELARIA	8	48 N	81 11 W	5.5
					RIO COCO	14	59 N	83 10 W	5.47
					RIO COLORADO	10	46 N	83 35 W	5.25
					RIO CRICAMALE	8	59 N	81 55 W	5.11
					RIO GONZALEZ	18	26 N	93 04 W	7.19
					RIO GRANDE	12	54 N	83 32 W	5.34
					RIO HUAHUA	13	53 N	83 27 W	5.38
					RIO INDIOS MORALES	23	24 N	97 46 W	7.38
					RIO MONTAGUA	15	44 N	88 13 W	6.38
					RIO PARISMINA	10	19 N	83 21 W	5.25
					RIO PIEDRAS	9	27 N	79 44 W	4.33
					RIO PRINZAPOLCA	13	25 N	83 34 W	5.38
					RIO QUEHUECHE	15	51 N	88 46 W	6.43
					RIO SAN FERNANDO	25	23 N	97 23 W	7.38
					RIO SAN JUAN	10	15 N	62 36 W	1.49
					RIO TONALA	18	13 N	94 08 W	7.21
					RIO TUXPAN	20	58 N	97 19 W	7.34
					RIO WALPASIXA	13	29 N	83 33 W	5.38
					RIOHACHA	11	34 N	72 55 W	4.6
					RISER PLATFORM NO. 1	10	10 N	61 51 W	1.42
					ROBINSON POINT	17	22 N	88 12 W	6.63
					ROCA DEL NORTE	11	16 N	63 45 W	2.3
					ROCA LAVENDERA	10	29 N	67 54 W	2.63
					ROCA MORROSQUILLO	9	36 N	76 00 W	4.18
					ROCK POINT	17	40 N	88 15 W	6.66
					ROCKLY BAY	11	10 N	60 44 W	1.7
					RONCADOR BANK	13	34 N	80 04 W	5.56
					ROSALIND BANK	16	26 N	80 31 W	6.3
					ROSARIO BANK	18	30 N	84 04 W	6.5
					<b>S</b>				
					SAIL ROCK	9	33 N	78 57 W	4.28
					SAINT D'EAU ISLET	10	46 N	61 31 W	1.14
					SAINT GILES ISLANDS	11	21 N	60 31 W	1.2
					SALINE BAY	10	42 N	61 01 W	1.15
					SAN FELIX	8	22 N	62 40 W	1.56
					SAN FERNANDO	10	17 N	61 28 W	1.39
					SAN JUAN DEL NORTE	10	56 N	83 42 W	5.26
					SAN LORENZO	9	47 N	71 04 W	3.23
					SANDBORE CAY	17	28 N	87 30 W	6.59
					SANTA MARTA	11	15 N	74 13 W	4.9
					SAPODILLA CAY	16	05 N	88 17 W	6.54
					SAPODILLA CAYS	16	07 N	88 16 W	6.54
					SAVANNA REEFS	15	10 N	82 25 W	6.5
					SAVONETTA POINT	10	25 N	61 30 W	1.34
					SCARBOROUGH	11	11 N	60 44 W	1.8
					SEAL CAY	12	25 N	83 17 W	5.33
					SEAL CAY	16	10 N	88 20 W	6.54
					SERRANA BANK	14	24 N	80 16 W	5.57
					SERRANILLA BANK	15	55 N	79 54 W	5.59
					SIERRA DE COCLE DE NORTE	9	02 N	80 34 W	5.3
					SIERRA NEVADA DE SANTA MARTA	10	49 N	73 48 W	4.7
					SINT JORIS BAAI	12	08 N	68 48 W	2.15
					SINT KRUISBAAI	12	18 N	69 09 W	2.15
					SINT NICOLAAS BAAI	12	26 N	69 54 W	2.23
					SISTER CAYS	9	16 N	82 21 W	5.18
					SITTEE POINT	16	48 N	88 15 W	6.50
					SITTEE RIVER	16	48 N	88 15 W	6.50
					SKIFF SAND	17	13 N	88 03 W	6.57
					SLA DEL MAIZ GRANDE	12	10 N	83 03 W	5.31
					SOLDADO ROCK	10	04 N	6	

	Position				Sec. Para		Position				Sec. Para
	°	'	°	'			°	'	°	'	
SPAANS LAGOEN	12	28 N	69	58 W	2.24	TYRREL'S BAY	11	18 N	60	32 W	1.5
SPAANSE HAVEN	12	04 N	68	51 W	2.18						
SPLIT HILL	9	09 N	82	10 W	5.12						
ST. MICHELBAII	12	09 N	69	01 W	2.16	<b>U</b>					
STANN CREEK TOWN	16	58 N	88	13 W	6.51						
SWAN ISLANDS	17	25 N	83	56 W	6.4	UATLATARA ROCKS	14	34 N	83	12 W	5.47
<b>T</b>						<b>V</b>					
TAMPICO	22	16 N	97	50 W	7.36	VALIENTE PEAK	9	10 N	81	55 W	5.8
TAPARO POINT	10	04 N	61	38 W	1.19	VALPATARA REEFS	14	27 N	82	58 W	5.42
TELA	15	47 N	87	27 W	6.33	VIVARIO BANK	15	54 N	83	22 W	6.8
THE RIO GRANDE	25	58 N	97	09 W	7.38	VIVARIO CAYS	15	50 N	83	18 W	6.8
THE SISTERS	11	20 N	60	39 W	1.3	VOLCAN SAN MARTIN TUXTLA	18	33 N	95	12 W	7.28
THREE FATHOM BANK	10	03 N	61	57 W	1.26	VOLCAN TURRIALBA	10	01 N	83	45 W	5.25
THUNDER KNOLL	16	27 N	81	20 W	6.3						
TIGER CAYS	9	13 N	81	55 W	5.8	<b>W</b>					
TIGER CHANNEL	9	11 N	81	59 W	5.10						
TOBACCO CAY	16	54 N	88	04 W	6.56	WATER CAY	16	49 N	88	05 W	6.56
TOBAGO	11	15 N	60	40 W	1.2	WATER CAY	17	23 N	88	04 W	6.63
TOCO BAY	10	50 N	60	57 W	1.12	WEST BREAKER	15	48 N	79	59 W	5.59
TRIANGULO ESTE	20	55 N	92	13 W	7.5	WESTPUNTBAAI	12	22 N	69	09 W	2.15
TRIANGULO SUR	20	54 N	92	14 W	7.5	WILLEMSTAD	12	07 N	68	56 W	2.17
TRINIDAD	10	30 N	61	15 W	1.10						
TRUJILLO	15	55 N	85	57 W	6.27	<b>Z</b>					
TSIANKUALAIA ROCK	14	20 N	83	04 W	5.43						
TUCACAS	10	48 N	68	19 W	2.68	ZOUTSTEIGER PIER	12	05 N	68	17 W	2.13
TURBO	8	06 N	76	43 W	4.24						
TURNEFFE ISLANDS	17	22 N	87	51 W	6.60						